



# Boughton Engineering Limited



## Operation & Maintenance Manual

### Power-Reach



## Skiploder

Incorporating Optional

## IntacoVa Sheeting System



"Over a century of British  
Engineering experience"

## Notes On Using Electronic Copies Of This Manual

The electronic copy of this manual is distributed in .pdf format.

The manual opens in single page view with a bookmark pane to the left.

The user can navigate the manual by:-

- Clicking on subject in [contents](#) page.
- Clicking on subject in bookmark pane.
- Scrolling through the document.
- Pressing next page / previous page arrows in the toolbar.

To quickly return to the contents page left click on “Return to Contents” located at the bottom of each page.

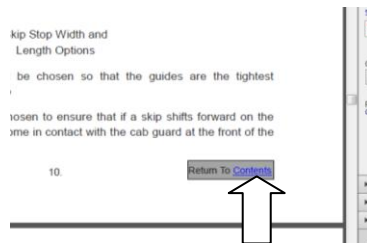

Links contained in this document are identified by [blue underlined text](#). These links take the user directly to the section described by the link text.

To return from a linked page to the previous page press the ALT key and the Left Arrow key, together, on the computer keyboard.

To toggle between bookmarks and thumbnails (shows a preview of all pages) in the left hand pane left click on:-

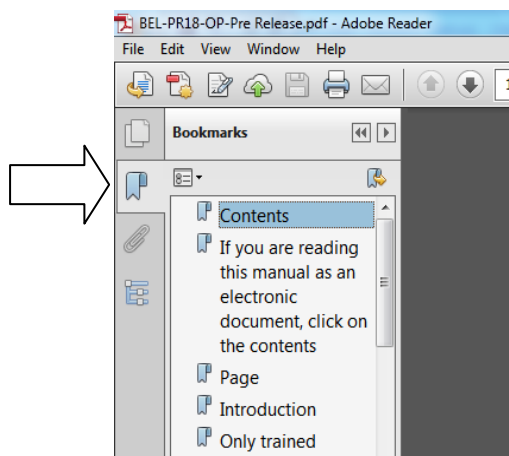

For Bookmark Menu

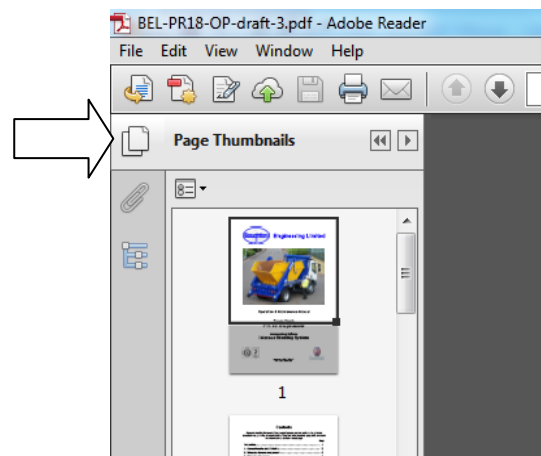

For Page Thumbnails

# Contents

If you are reading this manual as an electronic document, click on the contents description to go to the relevant section. To return to the contents page click on return to contents at the bottom of each page

	Page
Introduction.....	1
1. General Function and Limitations.....	2
2. Skiploader General Arrangement.....	5
3. Skiploader Weights & Dimensions.....	6
4. Intacova Dimensions.....	7
5. Main Control Valve Block Overview.....	8
6. Adjustable Skip Stops.....	10
7. Warning Lights.....	11
8. General Safety Checks Prior to Operating.....	12
9. Operating The Skiploader Equipment.....	14
9.1.Loading a Skip.....	14
9.2.Deploying Intacova Sheeting System.....	16
9.3.Retracting Intacova Sheeting System.....	17
9.4.Unloading a Skip.....	18
9.5.Tipping a Skip.....	20
10. Maintenance.....	23
Safety.....	23
Schedule.....	24
Daily Checks by the Vehicle Operator (Driver).....	24
Maintenance Schedule – Workshop.....	24
Maintenance Procedure 1 – Check and Fill Hydraulic Tank.....	25
Maintenance Procedure 2 – Filter Check/Change.....	26
Maintenance Procedure 3 – Chain Inspection.....	27
Maintenance Procedure 4 - Grease Points.....	28
Maintenance Procedure 5 – Grease Stabiliser Leg Stanchions.....	28
Maintenance Procedure 6 – Check Nut & Bolt Torque Values.....	29
Maintenance Procedure 7 – Renew Hydraulic Fluid.....	30
11. Declaration of Conformity.....	31
12. Further Information.....	32

# Introduction

This manual has been produced, by Boughton Engineering Limited, to ensure that users of the PR 18 Skiploader have all the information required to operate the equipment safely.

It is the responsibility of the operator's management to ensure that all health and safety requirements, relating to the use of this equipment, are accessed and that all personnel who use the equipment are aware of its functionality and limitations.

Only trained personnel should use this equipment.

This manual should be kept in a safe place in the vehicle cab. All users of the equipment should be made aware of the location of the manual and should be instructed to read through and familiarise themselves with its contents prior to operating the equipment.

The following symbols have been used, in this publication, to bring certain items relating to safety to the attention of the user of the equipment:-



Highlights a risk to personnel or the general public which could result in serious injury or death.



Highlights a risk to the equipment due to improper use.

Please take note of these symbols and take action to avoid unsafe operation of the equipment.

The information contained in this manual is correct at the date of publication. Boughton Engineering Limited reserves the right to modify the design and/or construction of its products, at any time.

# 1. General Function and Limitations

The PR 18 skiploader is designed for transporting materials contained in skips. The equipment allows the operator to lift and load, onto the bed of the vehicle and lift and unload, onto the ground, empty and loaded skips.

In addition this equipment can be used to tip skips provided that they have been designed for this purpose.

NOTE: This equipment you are using has been supplied to meet your specific requirements. Please ensure that only skips which meet the requirements of the original specification are used with this equipment.

Before lifting ensure that the skip dimensions are compatible with the equipment and that the skip is in sound condition.

Refer to CHEM TS14 – Skip Group B and Group C, for guidance on the general dimensions for skips which are suitable to be used with this equipment.

It is the responsibility of the user to determine the suitability of the equipment for loading and unloading skips which deviate from the specifications contained in this standard.

## WARNING

Failure to observe the limitations of the equipment and using non approved skips may result in serious injury and/or damage to the equipment.

This equipment must never be used:-

- To carry persons or animals.
- To raise the vehicle to change a tyre or carry out any other maintenance.
- To lift or pull any item other than approved skips.



The maximum permitted payload, for which this equipment is approved to lift and carry, is quoted on the load plate.

Maximum transferable loads are quoted for lifting from ground level.

For lifts below ground level the maximum transferable load will decrease.

Your Skiploader has been individually load tested after fitting to the chassis. It will operate with complete safety, provided the maximum transferable load, quoted on the load plate, is not exceeded.

Due to the variety of skip sizes that may be loaded, responsibility to ensure that the vehicle axle loads remain within the limits specified by the chassis manufacture and meet the requirements of any applicable legislation remains with the driver.

MAX TRANSFERABLE, 12500 KG AT GROUND LEVEL MINIMUM REACH
MAX TRANSFERABLE 7500 KG AT GROUND LEVEL MAXIMUM REACH
DO NOT EXCEED PLATED AXLE WEIGHTS, OR VEHICLE G.V.W.

Note: The equipment maximum transferable loads, quoted on the load plate, may exceed the maximum payload for which the vehicle is plated. Do not drive the vehicle on the highway if there is any doubt that the payload is within the limits required for the vehicle to operate legally.

Failure to observe plated and legislated axle loads may result in prosecution and /or damage to the vehicle.



**WARNING**

**Failure to observe the maximum permitted payload and/or plated axle loads may result in instability of the equipment during loading and unloading and/or instability of the vehicle when driving. Serious injury or damage to the vehicle or skiploader equipment may result.**



This manual also includes operating instructions for the Boughton Engineering Limited's Intacova sheeting system. This system is optional and may not be fitted to all vehicles.

The Intacova sheeting system is designed to make sheeting of loaded skips a quick and safe operation. Sheeting of the load is achieved remotely via the control block.

Loaded skips should be sheeted to ensure that the contents remain within the skip during operation on the highway.

Boughton Engineering Limited has designed and manufactured this equipment to meet all relevant safety regulations. The equipment design has taken into account ease of operation and maintenance, conforms to the requirements of the EU Machinery Directive 2006/42/EC and is CE marked in accordance with this directive.

This machinery emits A-weighted sound power up to a maximum level of 110 dB measured by tests laid down in SI 2001/170.



It is recommended that, when operating this equipment for prolonged periods, ear defenders are worn.

As with all machinery, during operation there are moving parts which pose a risk of pinching or crushing. Always apply the clearance zone rule, Section 8 point 2, when operating the equipment, to ensure that any risk to the public or animals is limited. The operator of the equipment should also consider pinching and crushing hazards and keep clear of all moving parts.



**WARNING**

**Always keep clear of moving parts when the skiploader equipment is operating. Failure to observe this warning may result in serious injury from pinching and crushing hazards.**

Any maintenance required on the skiploader equipment should be carried out by a qualified technician.

Spare parts used during repair and maintenance procedures must be approved by Boughton Engineering Limited.

Please refer to the equipment maintenance section of this manual, Section 10, and spare parts catalogue BEL-PR18-SP for information on procedures for maintaining the equipment in a safe operational condition.

#### **WARNING**

**Correct maintenance of this equipment is essential for safe operation. Always maintain the equipment to the schedule prescribed in the maintenance manual.**



**NEVER operate the equipment if there is a known fault. Take the vehicle out of service and affect a repair before returning into service.**



**ALWAYS use approved spares and recommended fluids and lubricants. Non approved items may seriously affect the performance and will increase the risk of a failure which may result in serious injury or damage to the equipment.**

## 2. Skiploader General Arrangement

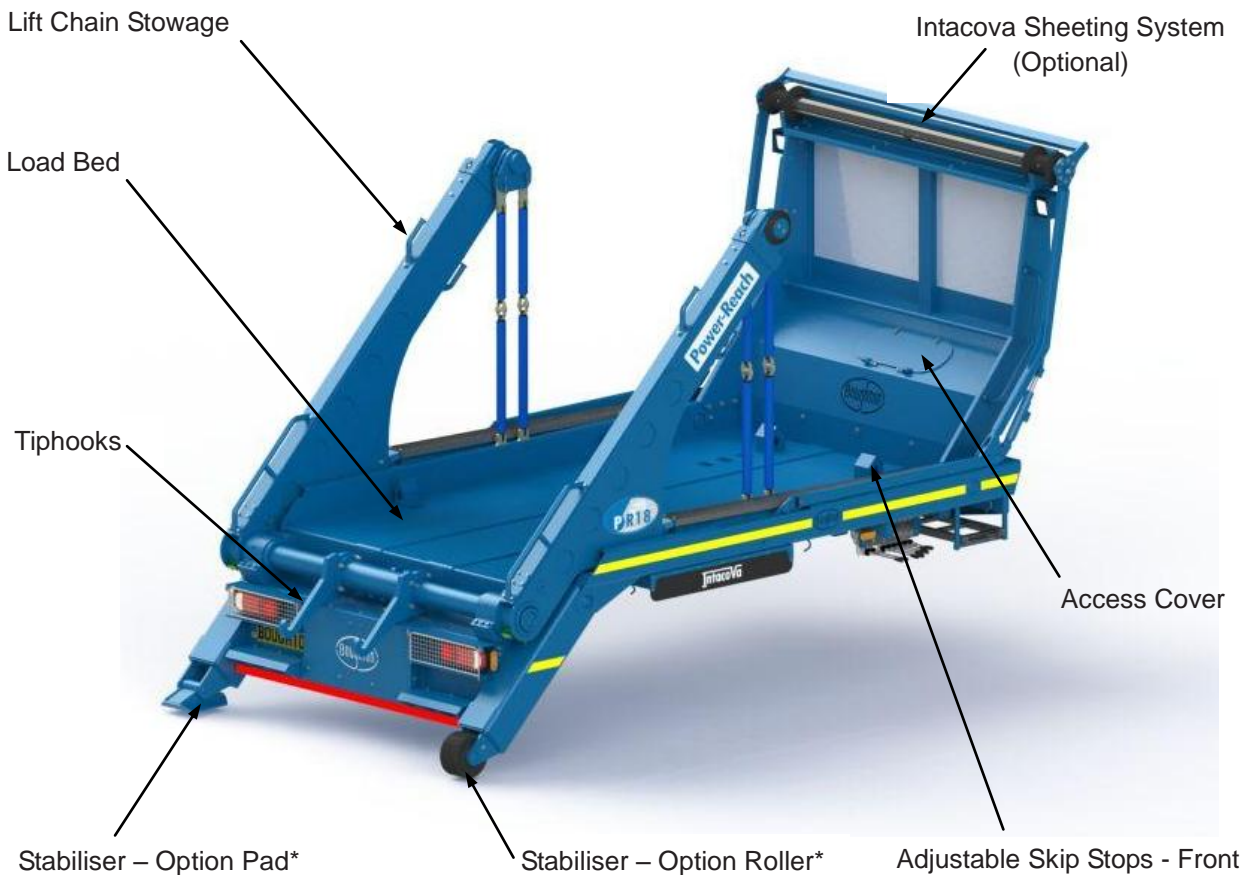
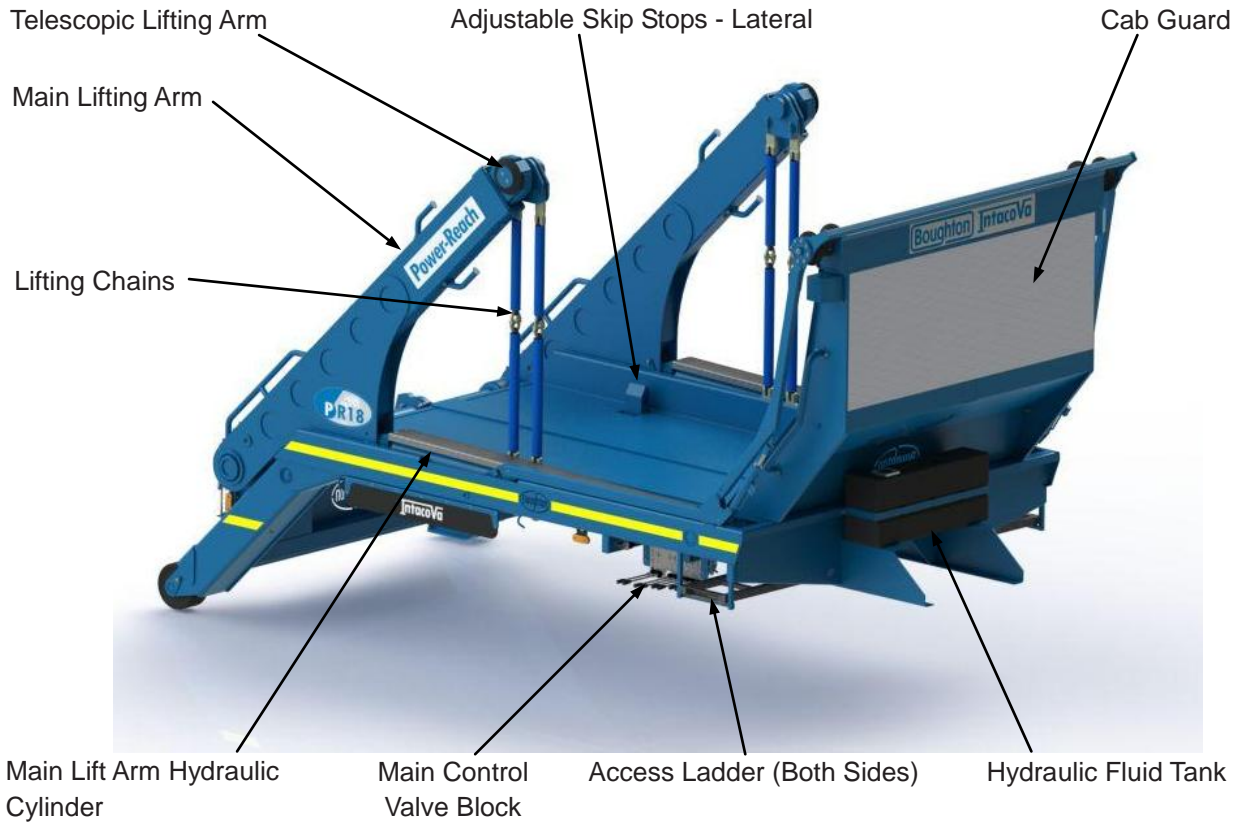

\* All skiploaders will have flat feet (Pad) rear stabilisers fitted unless the chassis is fitted with front axle parking brakes, in which case, roller stabilisers can be fitted



### 3. Skiploader Weights & Dimension

Model: Power-Reach – PR 18

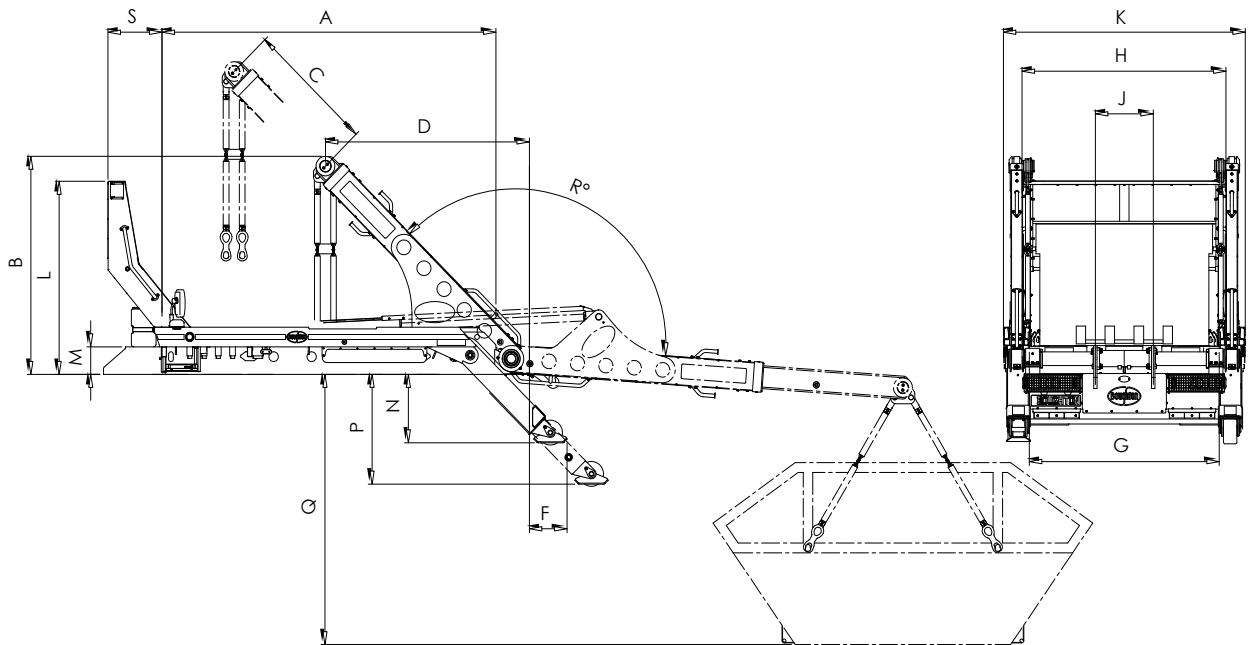

A	Bed Length	3520 mm
B	Height from top of chassis	2214 mm
C	Arm extension	1370 mm
D	Chassis cut-off to load centre	2149 mm
E	Overall length	4884 mm
F	Chassis cut-off to stabiliser (raised)	397 mm
G	Bed width	1990 mm
H	Distance between lift arms	2127 mm
J	Distance between tip hook centres	610 mm
K	Overall width	2540 mm
L	Overall height from top of chassis to top of cab guard	1963 mm
M	Chassis bed height	293 mm
N	Top of chassis to stabiliser (raised)	683mm
P	Top of chassis to stabiliser (lowered)	1116mm
Q	Maximum lift from below ground	2147mm
R	Load arm angle of rotation	139°
S	Cab guard overhang	567mm
Weight of Skiploader including PTO/Pump and hydraulic oil (excluding sheeting system)		3650kg
Safe working load (SWL) - arms in		12500kg
Safe working load (SWL) - arms out		7500kg

## 4. Intacova Dimensions

The information in this section relates to the Intacova sheeting system. This system is an optional fitment and may not be installed on all vehicles.

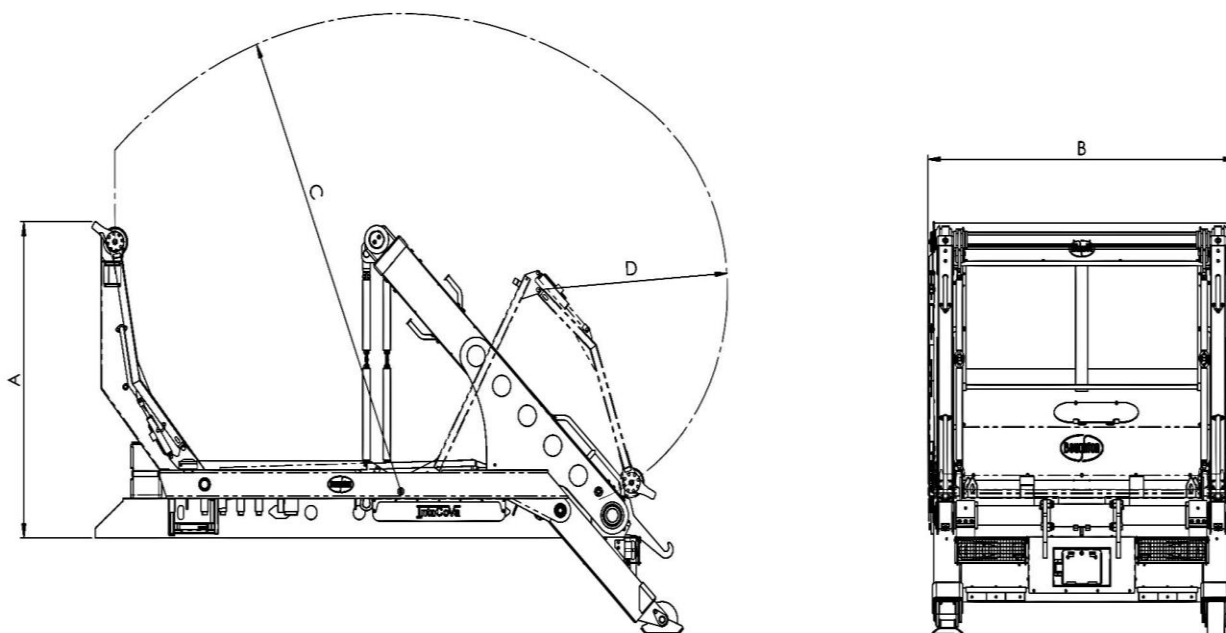

### IntaCova Dimensions

A	Height from top of chassis	2244mm
B	Maximum width	2550mm
C	Main arm maximum radius	3392mm
D	Secondary arm radius	1572mm

### Cycle Times

To sheet at 1500rpm	24 seconds
To unsheet at 1500rpm	24 seconds
To sheet at tickover	31 seconds
To unsheet at tickover	31 seconds

### Container Sheeting Range

4yd<sup>3</sup> (3.06m<sup>3</sup>) - 16yd<sup>3</sup> (12.23m<sup>3</sup>)

Containers should comply with C.H.E.M. standards

## 5. Main Control Valve Block Overview

Push Button  
(Tip Hooks  
Control)



Levers - A B C D E F G H

The skiploader equipment is operated using the hydraulic control block situated on the vehicle offset behind the cab.

**Lever A** – Hold to run lever - must be in either the up or down position when operating the equipment.

In the up position the equipment can carry out a fast unload sequence provided that any skip lifted is EMPTY.

During load or unload sequences, with loaded skips, lever A must be in the down position.

Note: All levers operate on the dead man principle and return to the neutral position if released. To activate any of the controls the user must apply pressure to lever A at all times.

**Levers G and H** operate the Intacova sheeting system. These levers will not be present if the Intacova system is not fitted to your vehicle.

### Standard Control Functions – Levers B,C,D,E & F

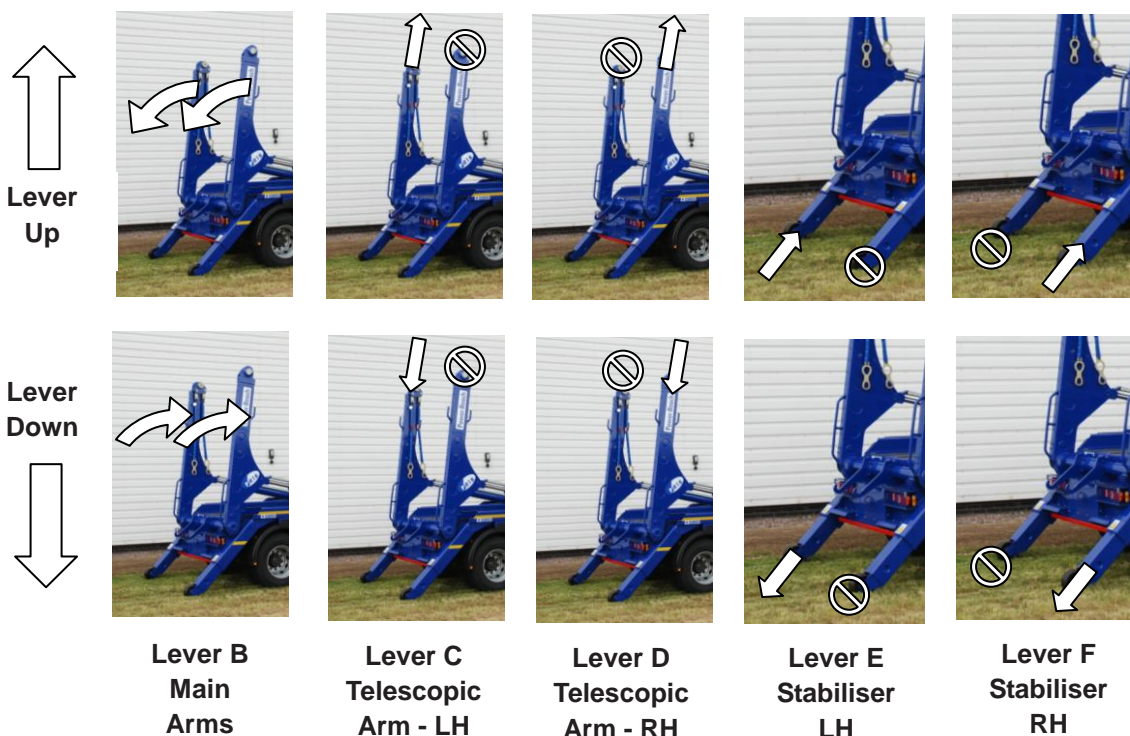

Note: When extending or retracting the telescopic arms and stabiliser legs operate both levers at the same time to synchronise left and right sides. Fine tune to level off by operating one or other lever.



Operate Levers Together To Synchronise.

### Standard Control Functions – Push Button

The push button located above and to the left of the control levers raises and lowers the tip hooks. When tipping the tip hooks must be in the raised position. For all other operations the tip hooks must be lowered.



Tip Hooks

### Optional Control Functions – Levers G & H

Levers G & H are only present on the control panel if the optional Intacova sheeting system is fitted to the vehicle.

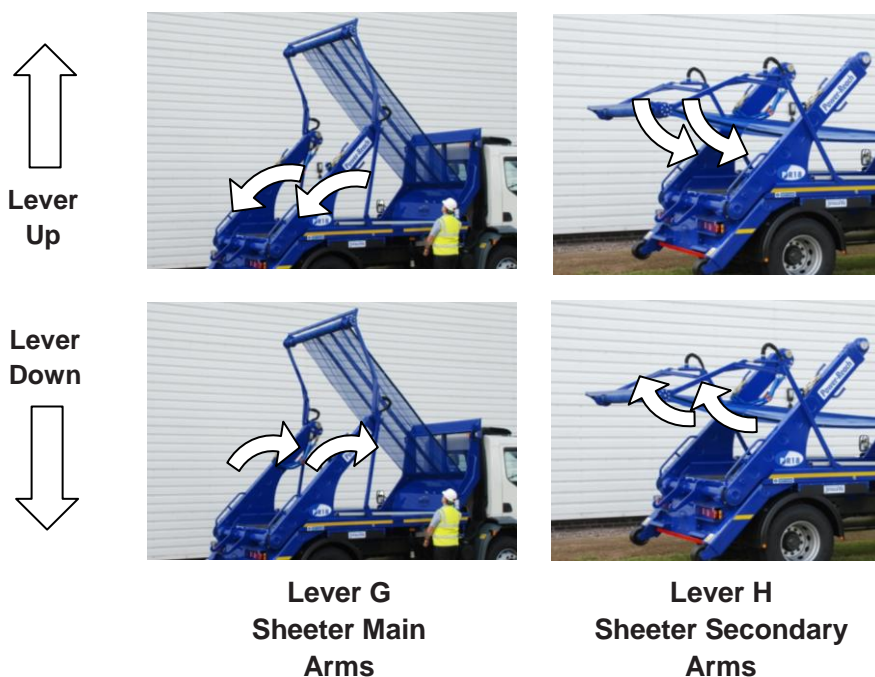

## 6. Adjustable Skip Stops

This vehicle is fitted with sockets towards the front and along the sides of the load platform.

Six skip stop blocks are supplied with the vehicle, two for positioning at the front of the platform and two pairs for positioning down the sides.



Adjustable Front Skip Stops



Adjustable Lateral Skip Stops

The skip stops, when fitted, restrain any potential forward or sideways movement of any skip loaded onto the vehicle.

Each stop is asymmetrical giving two stop positions for each socket depending on which way around the stop is inserted into the socket.

For the front stops there are effectively 8 positions.

For the side stops there are effectively 4 positions.

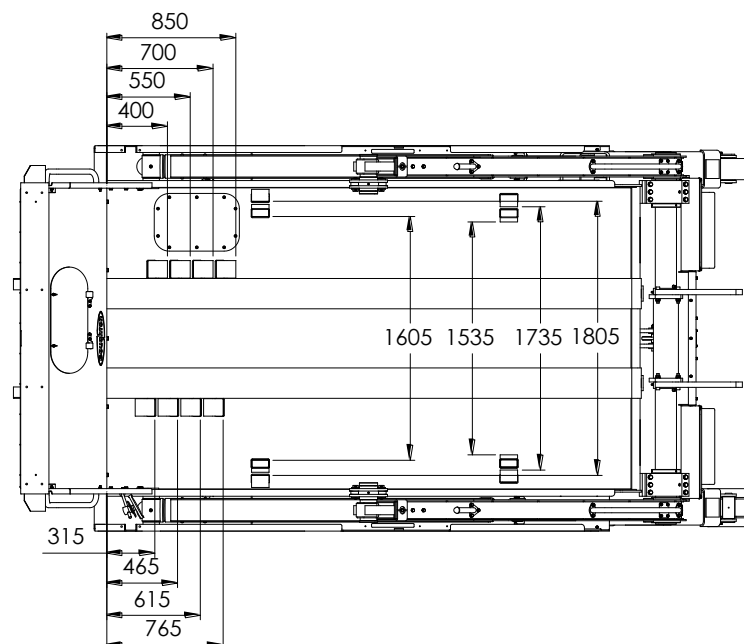

Skip Stop Width and Length Options

Side skip stop positions should be chosen so that the guides are the tightest practical fit to the width of the skip

Front stop positions should be chosen to ensure that if a skip shifts forward on the platform no part of the skip can come in contact with the cab guard at the front of the load bed.

## 7. Warning Lights

A bank of three LED warning lamps is located on the dashboard of the vehicle cab.



In Cab  
LED Warning  
Lamps

The warning lamps are activated by proximity sensors which detect:-

1. Stabiliser feet not in fully raised position.
2. Telescopic arms not in fully retracted position.
3. Main arms not in fully down position.

If any of the LED warning lamps is lit the driver of the vehicle should inspect the skiploader equipment to ascertain the positions of the three items listed above.

Note: The minimum travel height is the height of the skiploader equipment with the telescopic arms fully retracted and the main arms in the fully down position. The height quoted on the vehicle height notice, located in the vehicle cab, relates to the equipment when at the minimum travel height.

Operating the vehicle outside the overall height limit specified on the vehicle height notice may result in prosecution.



### WARNING

It is the drivers' responsibility to always ensure that the vehicle is operated within overall heights specified on the vehicle height notice located in the cab.

Failure to ensure that the vehicle height is within this limit may result in a collision which may cause damage to the vehicle and/or other structure.

Always ensure that, before driving on the highway, all LED warning lamps are extinguished.



Press Button To Test  
LED Operation

The LED warning lamps are fitted with a test button. It is recommended that the driver operates the test button after each load/unload sequence prior to driving off.

The button should be pressed and held. The warning lamp bank is operating correctly if all three lights illuminate.

## 8. General Safety Checks Prior To Operating

When operating the skiploader equipment it is essential that all precautions are taken to ensure the safety of the driver and the general public.

Operators of commercial vehicles will have procedures in place to minimize risks. These procedures should always be followed. In addition the following safety checks are specific to skiploader operations and should be carried out prior to any lifting operations:-

1. A general visual inspect of the skiploader equipment should be undertaken. Walk around the vehicle looking for any signs of damage to components. Look for patches of fluid under the vehicle. If fresh fluid is detected inspect the vehicle in the area above the patch to see if there are any leaks. If damage or leaks are detected take the vehicle for repair by a qualified technician.

### WARNING



**NEVER** operate the equipment if there is a known fault. Take the vehicle out of service and affect a repair before returning into service.



**Only qualified technicians should carry out repair of faulty equipment.**

**Continued use of faulty equipment may result in serious injury, death or damage to the equipment.**

2. Before loading or unloading a skip check the ground onto which the vehicle must drive to ensure it is stable enough to support the loads imposed through the stabilising legs. The ground should be essentially level. Although the stabilising jacks will level off a limited amount of inconsistency, in ground level, excessive slopes may result in an unstable lift.
3. Ensure that the area around the skip is clear. **DO NOT** carry out a loading or unloading operation if any person or animal is close to the vehicle or skip. It is recommended that a 1.5 metre clearance zone, around vehicle and skip, is applied.

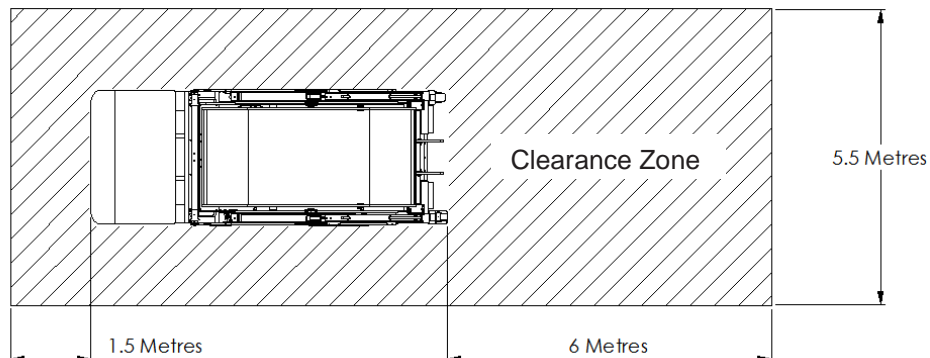

4. Check the area above the vehicle and lifting equipment. DO NOT lift if there is any risk of a collision.
5. When unloading ensure that there is adequate space to accommodate the skip. To reduce the risk of a crushing hazard it is recommended that there is space all around the skip when unloaded.
6. Check the skip prior to lifting to ensure that it is in sound condition. Take particular note of the condition of the lifting lugs and, if tipping, the tipping bar. If loaded check that the load is safely inside the skip and cannot fall out during the lift.  
It is the operator's responsibility to ensure that a skip is not overloaded. Check the skip load. If there is any doubt that the skip may be overloaded DO NOT attempt a lift.
7. Check the lifting chains to ensure that they are in sound condition. Make sure that the chains are not knotted or twisted.

**WARNING**

**Lift chains are critical safety components.**



**DO NOT attempt to modify the lift chains by changing their length.  
DO NOT attempt repair of chains by cutting or welding.**



**If a chain is damaged or worn beyond usable limits it must be replaced.**

**Serious injury and/or damage to the vehicle may result from using damaged or worn lift chains.**



# 9. Operating The Skip Loader Equipment

In these instructions the following symbols are used to indicate the correct levers to operate when completing an instruction:-

Push Button ○

⊙ ⊙ ⊙ ⊙ ⊙ ⊙ ⊙ ⊙

Levers - **A B C D E F G H**

- Lever Up
- Lever Down
- Push Button
- Pull Button

Note: Limit the operation of the hydraulic system to 30 minutes at a time where possible. Excessive operation will warm up and thin the hydraulic fluid resulting in reduced performance.

## 9.1. Loading a Skip

Prior to starting operation read through the [“General Safety Checks Prior To Operating” section 8](#), and assess the skip and its location to ensure that it is suitable for lifting.

1. Reverse skiploader vehicle to a position in front of the skip. Position the rear of the vehicle as close to the skip as possible.
2. Apply hand brake.
3. Engage PTO.
4. Check that the tip hooks are in the down position.

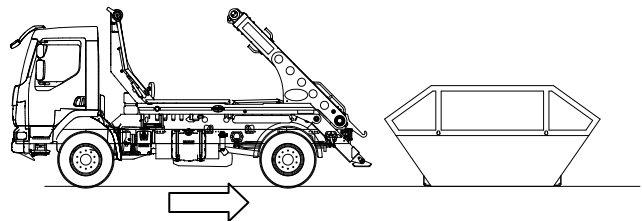

If the tip hooks are up, push the tip hook button in to lower.

Button: ⊙ ⊙ ⊙ ⊙ ⊙ ⊙ ⊙ ⊙

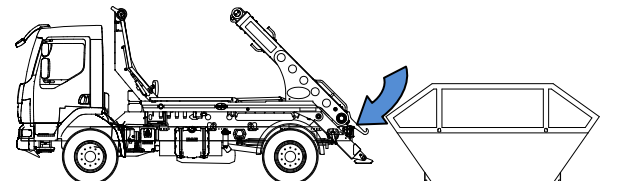

5. Extend stabiliser legs. The legs should be extended so that the load is just removed from the rear suspension.

Levers: ○ ⊙ ⊙ ⊙ ⊙ ⊙ ⊙ ⊙ ⊙ ⊙ ⊙

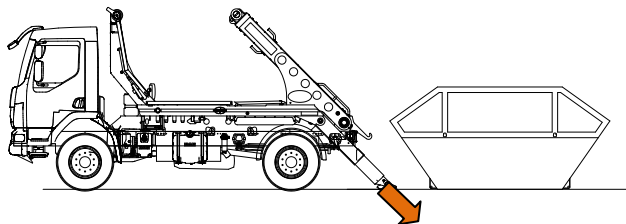

Note: The stabilisers should be used to level the rear of the vehicle. The rear wheels should remain in contact with the ground to retain the effectiveness of the handbrake.

6. Rotate the main arms. Use the fast unload (move lever A up).

Rotate arms until the chain pivot is just above skip top.

Levers: ○ ⊙ ⊙ ⊙ ⊙ ⊙ ⊙ ⊙ ⊙

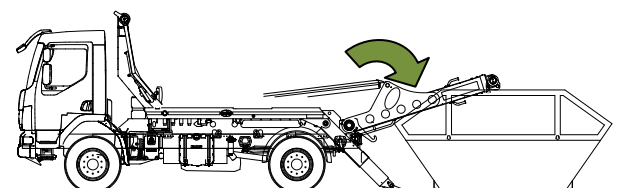

7. Extend the telescopic arms, if necessary, to place the chain pivot centrally over the skip lifting lugs.

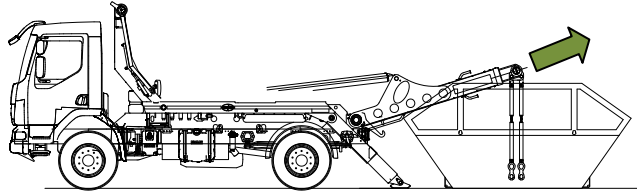
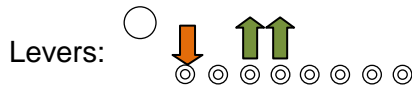

8. Attach the four chain key plates to the lifting lugs. Ensure that the plates are fully over the lug and that the chains are not twisted or tangled.



9. Lift the skip off the ground using the main arms.

Note: To ensure that the skip does not collide with the rear of the vehicle use the telescopic arms to increase clearance. Keep the skip as close to the vehicle as possible whilst maintaining clearance.

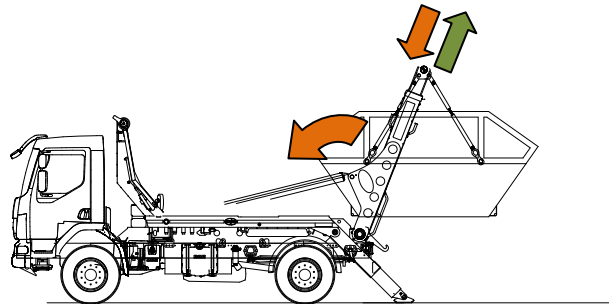
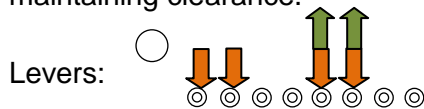

Stop the loading cycle just prior to the skip resting on the load bed and check that the skip stops have been correctly positioned.

**WARNING**



Do not attempt to reposition the skip stops with the skip supported on chains over the platform. Remove the skip from over the load bed reposition the guides then reload the skip. Failure to observe this warning will result in a potential crushing hazard which may cause serious injury or death.

10. With correctly positioned skip stops complete the loading sequence by resting the skip on the load bed.

Ensure that the main arms are rotated to the fully down position and that the telescopic arm is fully retracted.

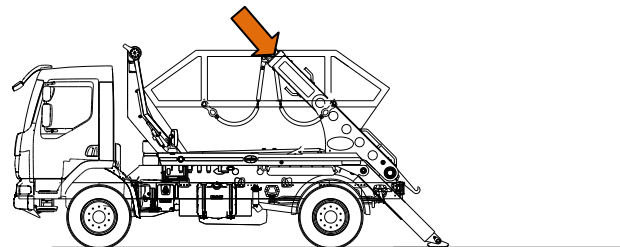
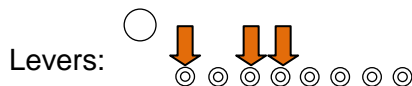

11. Retract the stabiliser legs.

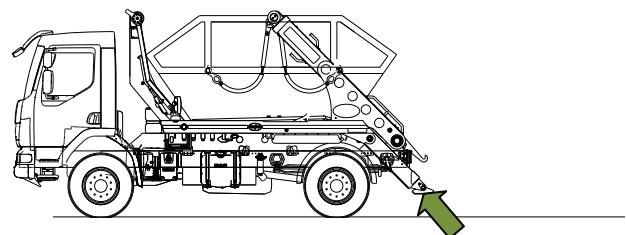
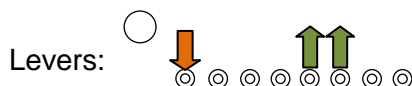

Prior to driving on the highway a check should be made to ensure that the vehicle and its load are safe.

Check LED warning lamps in cab. If any lights are illuminated check:-

- 1) Main arms.
- 2) Telescopic arms
- 3) Stabilisers

Ensure that they are in the safe driving position.

If no sheeting system is fitted and the vehicle is ready to depart ensure that the PTO is disengaged.

If the vehicle is fitted with an Intacova sheeting system deploy the sheeting system prior to driving off, see below.

## 9.2. Deploying Intacova Sheeting System

The Intacova sheeting system (when fitted) must always be deployed when carrying a loaded open top skip to prevent potential loss of load during transit.

1. With the skip in position on the vehicle load bed activate the Intacova main arms bringing the sheeting system over the skip.

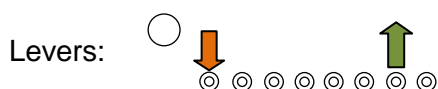

2. Operate the main arms until the sheeting roller has rotated beyond the rear of the skip.



3. Activate the Intacova secondary arms. The sheeting roller will move forward, in an arc, pulling the sheet over the rear of the skip. Continue operating the secondary arms until the roller contacts with the main lifting arms.

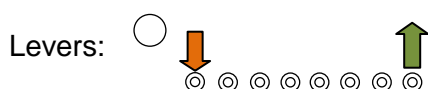

With the sheeting system deployed disengage the PTO prior to departure.

## 9.3. Retracting Intacova Sheeting System

Prior to unloading or tipping a skip ensure that, if fitted, the Intacova sheeting system has been retracted.

1. Engage PTO.
2. Rotate secondary arms away from the rear of the skip.

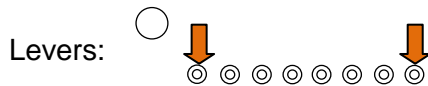

3. Ensure sheeting roller is clear of the rear of the skip before proceeding.



4. Activate the Intacova main arms to bring the sheeting system over the skip towards the load bed cab guard.

A continual check must be made to ensure that no collision takes place between the Intacova and any other part of the vehicle structure during this operation.

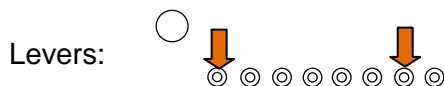

5. The Intacova sheeting system is fully retracted when the main arm spigot is engaged in the socket on the side rave of the load bed and the sheet roller is sitting down in the cups at the top of the cab guard.

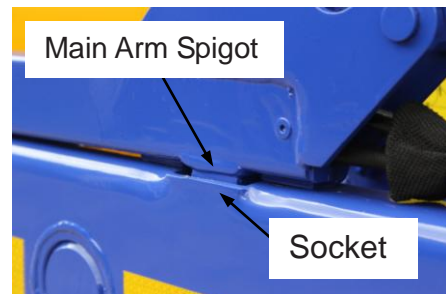

It may be necessary to further use the sheeter main arm and secondary arm controls to ensure that the system is fully retracted and in the drive away position.

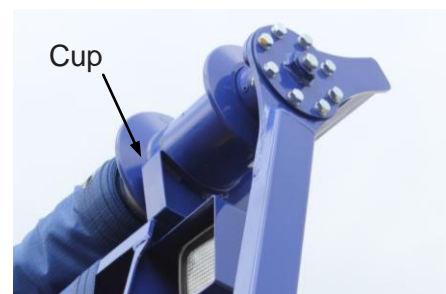

### WARNING

Ensure that the Intacova sheeting system is fully retracted before driving the vehicle. Failure to fully retract the sheeting system may result in damage caused through collision.

## 9.4. Unloading a Skip

Prior to starting operation read through the [“General Safety Checks Prior To Operating” section 8](#), and assess the proposed unload location to ensure that it is suitable.

Take particular note of the available space and stability of the ground and ensure that there is adequate clearance behind the vehicle to accommodate the skip when unloaded.

1. Drive the vehicle into position.

2. Apply handbrake.

3. Engage PTO.

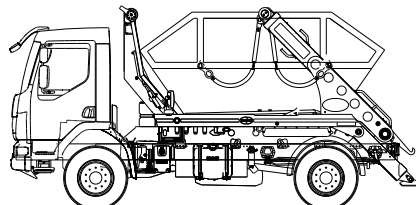

4. Extend stabiliser legs. The legs should be extended so that the load is just removed from the rear suspension.

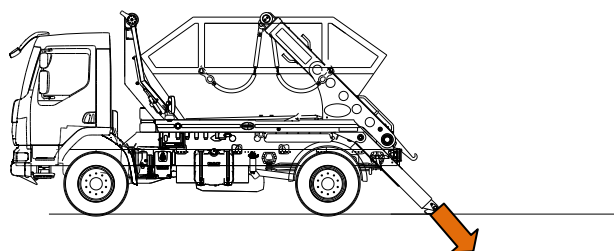
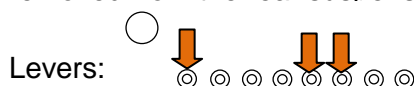

Note: The stabilisers should be used to level the rear of the vehicle. The rear wheels should remain in contact with the ground to retain the effectiveness of the handbrake.

5. Check that the tip hooks are in the down position.

If the tip hooks are up, push the tip hook button in to lower.

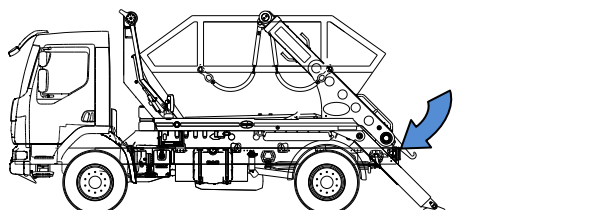
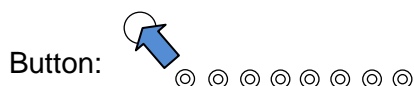

6. Check that all four chains are securely attached to the skip lifting lugs.

7. Rotate the main arms and lift the skip off the load platform.

Note: It may be necessary to extend the telescopic arms, prior to lifting, to avoid the skip dragging back along the platform. Check that the chain pivot is central over the skip just as the chains tighten.

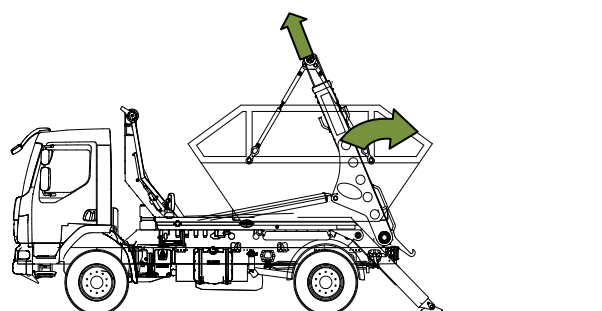

Note: If an empty skip is being unloaded the fast unload facility may be used. Lever A and lever B should be in the up positions for fast unload. This function will not operate if an attempt is made to lift a fully loaded skip.

**Note:**

When operating in fast unload mode the main arm lever will operate in the unload direction when in the up or down position. Care must be taken if circumstances arise which require the skip to be reloaded onto the vehicle. Lever A and lever B must be moved to the down position to facilitate reloading of the skip.

8. Continue the off load using the main arms.

Rotate the skip over the rear of the vehicle and onto the ground.

Continue rotating the main arms until there is sufficient slack in the lift chains to allow them to be disconnected from the skip lifting lugs.

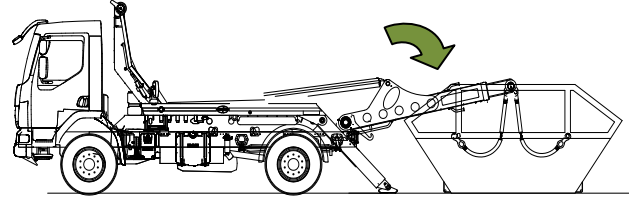

9. Detach the chains from the skip lifting lugs and stow on the chain hooks provided on the main lift arms.

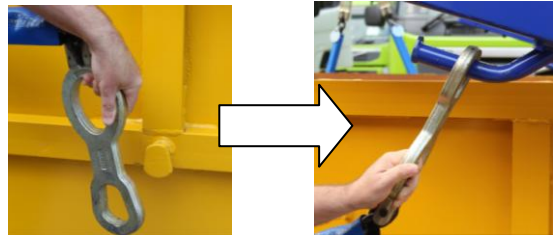

10. Rotate main arms until they are in the fully down position.

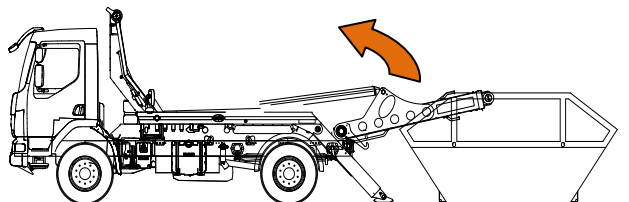
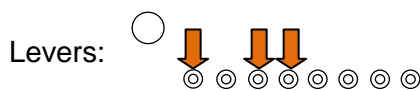

11. Retract telescopic arms around until they are in the fully down position.

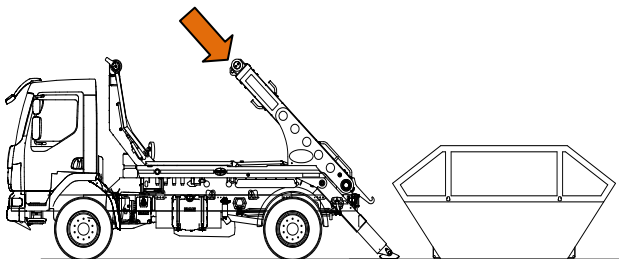
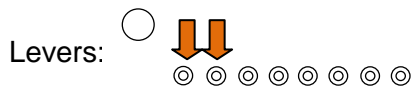

12. Retract the stabilisers.

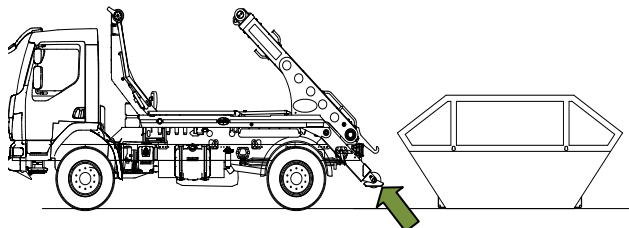
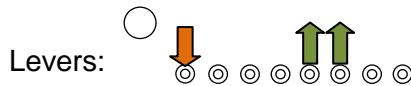

A check should be made to ensure that the vehicle skiploader system is correctly set up prior to driving on the highway.

Check LED warning lamps in cab. If any lights are illuminated check:-

- 1) Main arms.
- 2) Telescopic arms
- 3) Stabilisers

Ensure that they are in the safe driving position.

Disengage the PTO prior to departure.

## 9.5. Tipping a Skip

The skiploader system can be used to tip a loaded skip provided the skip is equipped with tipping bars designed for the purpose.

Prior to starting operation read through the “[General Safety Checks Prior To Operating](#)” [section 8](#), and assess the skip and the intended tipping location to ensure that they are suitable.

Any sheeting must be removed from the skip prior to commencing the tipping procedure. [Refer to section 9.3](#) for instructions on retracting the Intacova sheeting system.

1. Drive the vehicle into position.
2. Apply handbrake.
3. Engage PTO.

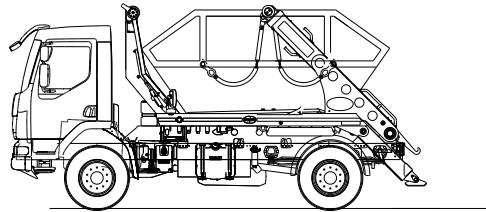

4. Extend stabiliser legs. The legs should be extended so that the load is just removed from the rear suspension.

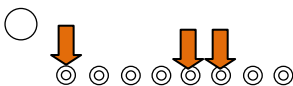
Levers: 

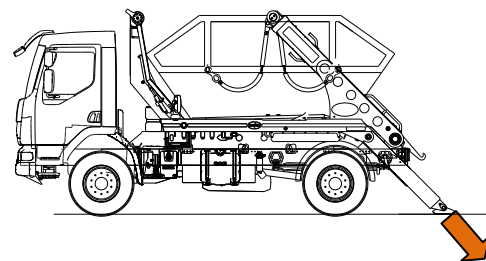

Note: The stabilisers should be used to level the rear of the vehicle. The rear wheels should remain in contact with the ground to retain the effectiveness of the handbrake.

5. Check that all four chains are securely attached to the skip lifting lugs.

6. Raise the tip hooks.

Button: 

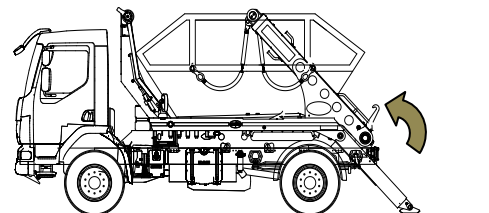

7. Rotate the main arms and lift the skip off the load platform.

Note: It may be necessary to extend the telescopic arms, prior to lifting, to avoid the skip dragging back along the bed. Check that the chain pivot is central over the skip just as the chains tighten.

Levers: 

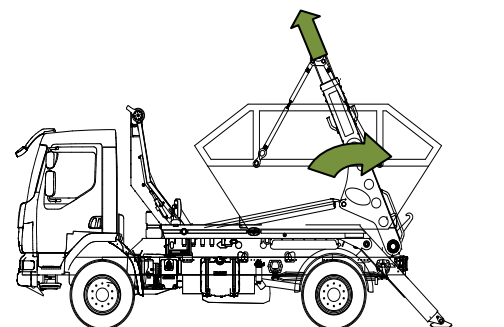

8. Rotate the main arms around until the tipping bar on the skip contacts the leading edge of the tip hooks.  
The tipping bar should contact the leading edge approximately 100mm below the throat of the hook.  
Use the telescopic arms to adjust the height of the skip until the required 100mm is achieved.

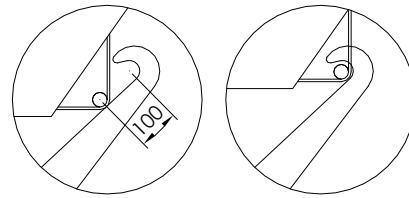

Correct                      Incorrect

Once the skip tipping bar is correctly located against the leading edges of the tip hook the telescopic arms must not be operated throughout the remainder of the tipping sequence.



**WARNING**  
If the skip tipping bars are engaged directly into the throat of the tip hooks, or the telescopic arm controls are operated when the skip tip bars are engaged in the throat of the tip hooks, the tip hooks and mountings may be damaged.

9. Rotate the main arms rearward, allowing the tipping bar to engage in the throat of the hook. The skip will start to tip as the main arms rotate.

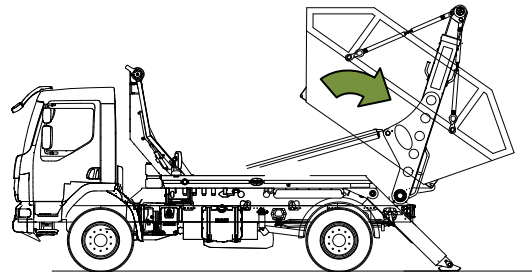

10. Continue rotating the main arms rearward until the load has cleared the skip. Do not allow the skip to touch the ground or any other obstacle during the tip cycle.

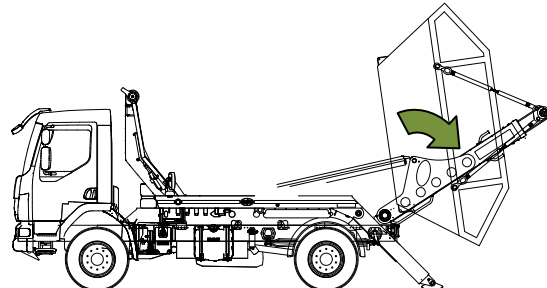

**WARNING**  
During the tip cycle, in the event that the load does not discharge under no circumstances should anyone attempt to dislodge the load manually with the skip in the tipped condition. Return the skip to the horizontal position and repeat the tip cycle.  
**Do not walk behind the vehicle at any time when tipping.**

11. On completion of the tip rotate main arms forward to return the skip to the horizontal position.

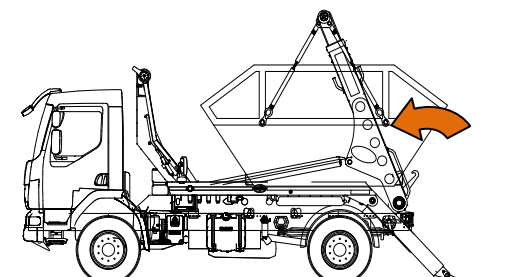
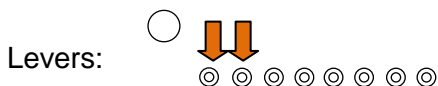



12. Complete the loading sequence by resting the skip on the load bed.

Ensure that the main arms are rotated to the fully down position and that the telescopic arm is fully retracted.

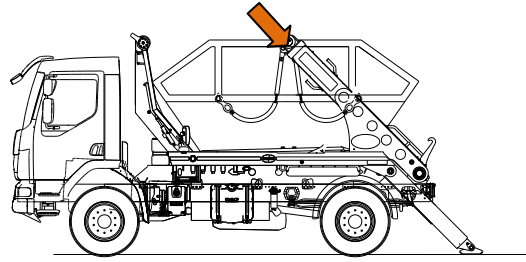
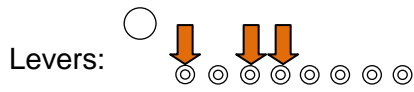

13. Retract the stabilisers.

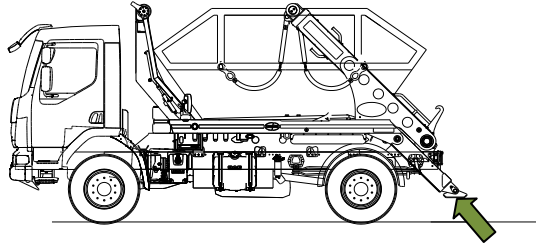
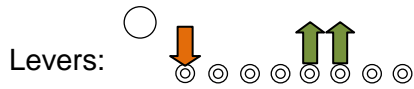

14. Lower the tip hooks.

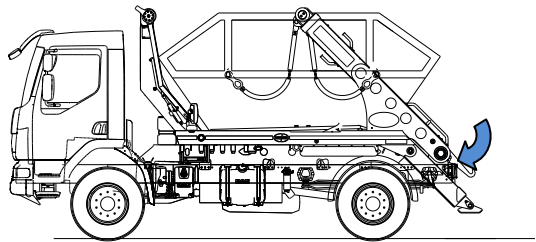
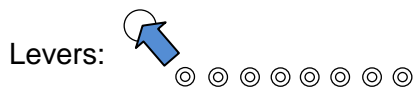

A check should be made to ensure that the vehicle skiploader system is correctly set up prior to driving on the highway.

Check LED warning lamps in cab. If any lights are illuminated check:-

- 1) Main arms.
- 2) Telescopic arms
- 3) Stabilisers

Ensure that they are in the safe driving position.

Disengage the PTO prior to departure.

## 10. Maintenance



### SAFETY



#### WARNING

Correct maintenance of this equipment is essential for safe operation. Always maintain the equipment to the schedule prescribed.

Only trained technicians should be permitted to carry out maintenance and repair work on the skiploader equipment.

**NEVER** operate the equipment if there is a known fault. Take the vehicle out of service and affect a repair before returning into service.

**DO NOT** carry out any modification or adjustment (not described in this manual) to the skiploader equipment without obtaining written consent from Boughton Engineering Ltd.

Maintenance work should always be carried out with the vehicle unladen. In the event of emergency repairs, by the roadside, all efforts must be made to remove any load prior to commencing work.

When working on the equipment always ensure that it is disabled to prevent accidental operation of moving parts. Remove the vehicle ignition key unless a test on the equipment is to be run. Ensure that the area around and under the vehicle is clear before activating and operating the equipment.

Work should be carried out with rams in the closed position wherever possible.

**ALWAYS** ensure that hydraulic systems are unpressurised before disassembly. When working with hydraulic fluids care must be taken to avoid contact with the skin and/or ingestion.

Hydraulic fluid can be harmful to the environment. Clean up any spillages immediately and dispose of any waste fluid conscientiously.

**ALWAYS** use approved spares and recommended fluids and lubricants. Non approved items may seriously affect the performance and will increase the risk of a failure.

After carrying out maintenance or repair work a check should be made to ensure that all safety devices operate correctly.

## Schedule

Safety, life expectancy and performance of the skiploader equipment is significantly enhanced if maintenance is carried out as prescribed.

The vehicle and skiploader equipment should be washed regularly (recommend washing weekly and more frequently if the type of operation demands). A build up of tipped materials on the bed, or around all moveable parts, can cause damage. In particular pay attention to the hydraulic cylinders, pivot points and stabiliser leg within the stabiliser housings. Wipe, with a clean cloth, all exposed piston rods.

### Daily Checks by the Vehicle Operator (Driver)

Check	Check Type	Action
Check for hydraulic leaks.	<b>Visual</b>	Immediately report any leaks for investigation and repair.
Check hydraulic tank level. Use sight gauge – cylinders must be closed.	<b>Visual</b>	Immediately report low levels for rectification – <a href="#">Maintenance procedure 1.</a>
Check Hydraulic fluid filter is not blocked.	<b>Visual</b>	Immediately report a blocked filter for rectification – <a href="#">Maintenance procedure 2.</a>
Check for pneumatic leaks.	<b>Audible</b>	Immediately report any leaks for investigation and repair.
Check operation of the in cab warning lights.	<b>Operation</b>	See <a href="#">section 7</a> for warning light checks. Report for investigation and repair if warning lights fail test or warning lights do not extinguish.
Check condition of lift chains.	<b>Visual</b>	Immediately report any damage or wear. Replace chains before commencing operation – <a href="#">Maintenance procedure 3.</a>
Check condition of hydraulic hoses.	<b>Visual</b>	Immediately report any damage for investigation and repair.
Check condition of all structural parts of lift equipment.	<b>Visual</b>	Immediately report any damage for repair.

### Maintenance Schedule – Workshop

The following schedule and procedures should be carried out by a qualified technician in a workshop environment.

#### RECOMMENDED HYDRAULIC OIL

Fuchs Renolin CL32  
Hydraulic Oil 'A'  
Mobil D T E 25  
Shell Tellus 46  
Castrol Hyspin AWS 46

#### RECOMMENDED GREASE

Fuchs (Century Oils) Renolit MP3  
Mobilgrease MP  
Shell Alvania R3  
Castrol Spherol AP3

	6 Weekly	6 Monthly	Annually	Procedure
Daily Checks – See Above	x	x	x	<a href="#">1</a> , <a href="#">2</a> & <a href="#">3</a>
Grease all grease points	x	x	x	<a href="#">4</a>
Grease stabiliser leg stanchions	x	x	x	<a href="#">5</a>
Check nut and bolt torque values	x	x	x	<a href="#">6</a>
Replace hydraulic fluid filter	*See Note	x	x	<a href="#">2</a>
Renew hydraulic fluid			x	<a href="#">7</a>

\*Note

Due to initial component bedding in, the hydraulic fluid filter must be changed at the first 6 weekly maintenance check. Thereafter filters should be changes every 6 months.

## Maintenance Procedure 1 – Check and Fill Hydraulic Tank

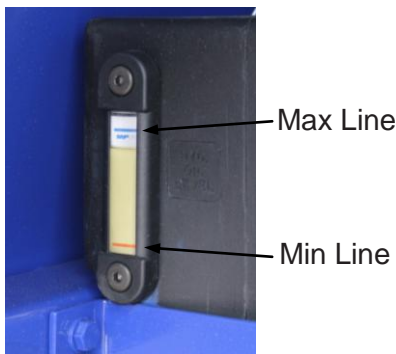

Hydraulic Tank  
Site Gauge

The level of fluid in the hydraulic tank can be checked using the site glass situated on the tank offside.

Prior to checking the fluid levels ensure that all hydraulic cylinders are in the full closed position.

The fluid level must be between the maximum and minimum indicator lines.

If the level of fluid is near to or below the min line then the fluid must be topped up.

**Note: Topping up of the hydraulic should be carried out by a qualified technician in the workshop:-**

- 1) Access the top of the hydraulic tank through the hatch at the base of the platform bulkhead (fig 1.1).
- 2) Unscrew the tank filler cap (fig 1.2).
- 3) Top up the tank to the maximum level line using recommended fluid types.
- 4) Check that the tank filler cap vents are clear before replacing filler cap.



Fig 1.1. Access Panel

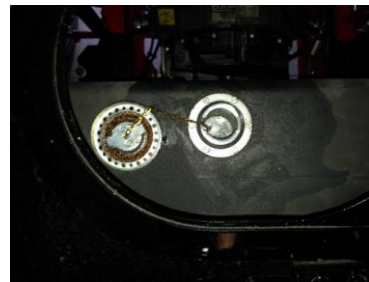

Fig 1.2. Filler Cap Removed

## Maintenance Procedure 2 – Filter Check/Change



Filter Housing With Pressure Gauge

To check to ensure that the hydraulic fluid filter is not blocked the PTO must first be engaged.

View the filter housing, located on the top of the hydraulic fluid tank, from the vehicle offside.

The gauge on the side of the housing indicates the line pressure in the return line.

The gauge must show a pressure reading in the green zone.

If the reading is in the red zone this indicates a blockage and the filter should be removed and replaced

**Note: Changing the hydraulic fluid filter should be carried out by a qualified technician in the workshop:-**

- 1) Ensure PTO is disengaged.
- 2) Access the top of the hydraulic tank through the hatch at the base of the platform bulkhead (fig 2.1.).
- 3) Turn the filter cap anticlockwise to remove and gain access to the filter (fig 2.2).

Note: The filter cap is sprung against the filter and will be pushed away from the housing when the threads disengage.

- 4) Remove the filter from the housing (fig 2.3).
- 5) Fit a new filter (fig 2.4).
- 6) Replace filter cap. Note: Push the filter cap down, to compress the filter spring, and turn clockwise to engage the threads (fig 2.5).



Fig 2.1



Fig 2.2



Fig 2.3

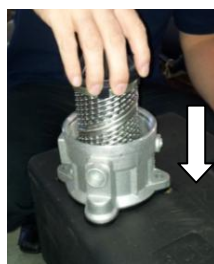

Fig 2.4

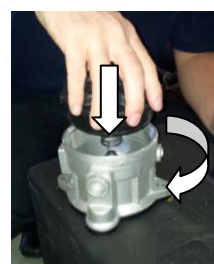
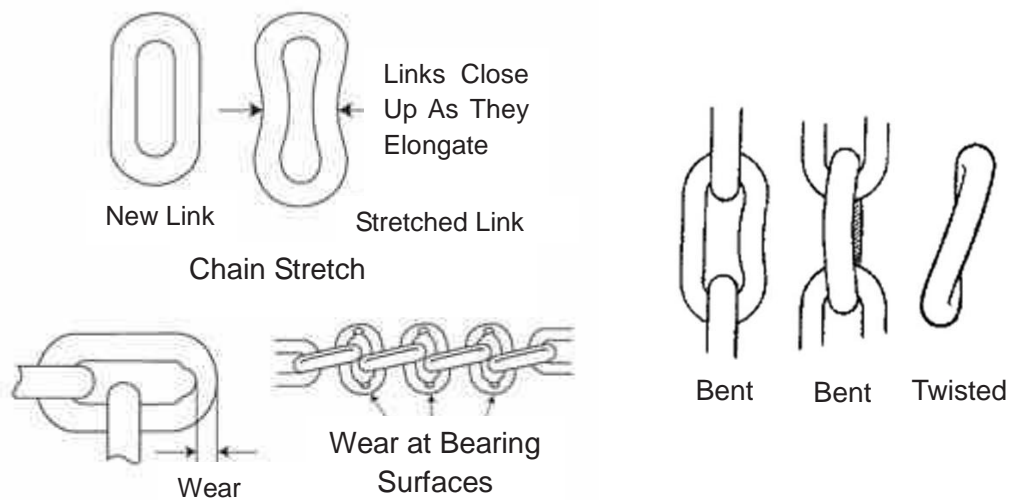

Fig 2.5

## Maintenance Procedure 3 – Chain Inspection

Lift chains should be carefully inspected to ascertain if they are serviceable. Check that the chain does not exhibit the following characteristics:-

- 1) Chain stretch – the links of the chain elongate causing the overall chain length to increase.
- 2) Deformation through bending or twisting of the links.
- 3) Chain wear – the links wear at the bearing surfaces weakening the chain and causing the overall chain length to increase.
- 4) Cracks in the links.



Any chain exhibiting any of these characteristics should be replaced and taken out of service.

### WARNING

Lift chains are critical safety components.



**DO NOT** attempt to modify the lift chains by changing their length.  
**DO NOT** attempt repair of chains by cutting or welding.



If a chain is damaged or worn beyond usable limits it must be replaced.

**Serious injury and/or damage to the vehicle may result from using damaged or worn lift chains.**

## Maintenance Procedure 4 - Grease Points

Grease points are located as shown in the diagram below.

Use a grease gun to apply grease to the bearing surfaces at these locations.

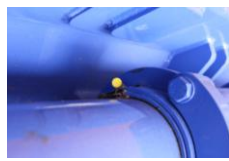

Tiphook Pivot Bearing



Chain Mounting Pivot



Main Hydraulic Cylinder Pivot Rear

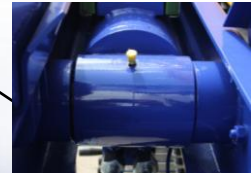
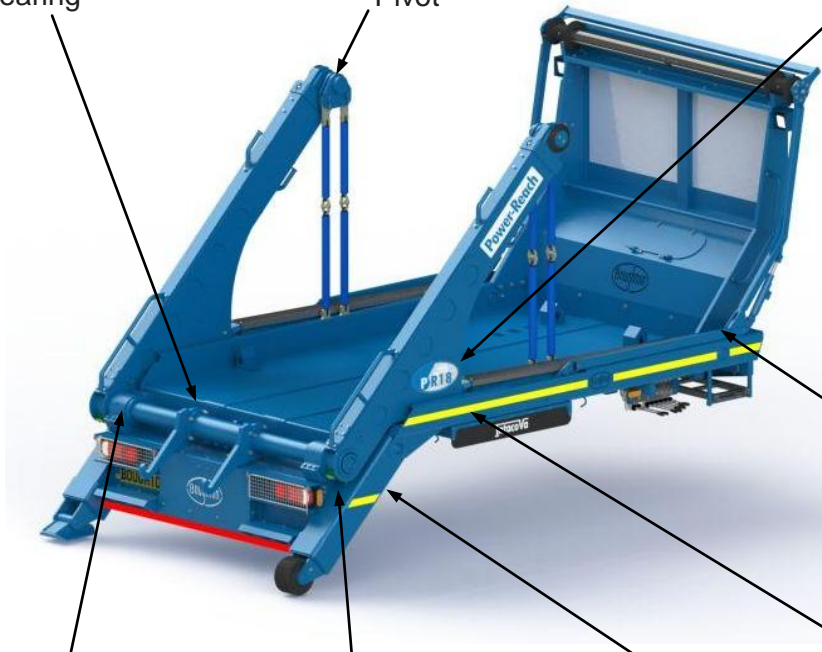

Main Hydraulic Cylinder Pivot Front



Main Arm Pivot Bearing



Stabiliser Rear

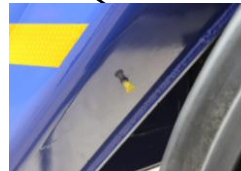

Stabiliser Front



Intacova (Optional) Main Arm Lower

## Maintenance Procedure 5 – Grease Stabiliser Leg Stanchions

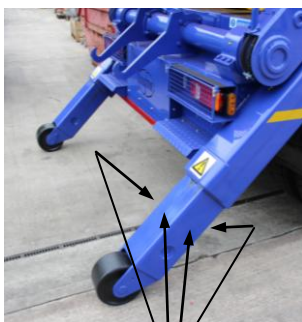

Apply Grease to All Surfaces

Apply grease to the stabiliser leg inner stanchion.

Extend the stabiliser leg to expose the inner box surfaces.

The grease should be applied liberally to the box section surfaces and spread using a brush.

After application retract the stabiliser legs and clean away any excess grease.

## Maintenance Procedure 6 – Check Nut & Bolt Torque Values

All nuts and bolts should be checked to ensure that they are at the correct torque.  
Use a calibrated torque wrench set to the required torque.

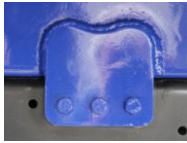

Recommended tightening torque for the chassis mounting bolts – 201Nm.

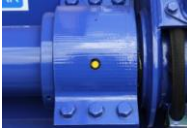

Recommended tightening torque for main arm pivot cap bolts - 312Nm.

For all other fasteners use the following table which gives recommended tightening torques for various metric bolts.

Quoted 'U' torque values are for self colour un-lubricated bolts and zinc plated bolts into un-plated holes and nuts.

Quoted 'P' torque values are for zinc plated bolts into zinc plated nuts.

For cap screws use grade 10.9 torque values.

Nominal Bolt Size	Grade 8.8 'U' Torque Nm		Grade 8.8 'P' Torque Nm		Grade 10.9 Torque Nm	
	Course	Fine	Course	Fine	Course	Fine
M6	10.9	-	12.7	-	15	-
M8	25.8	27.7	31	33.2	36.3	38.9
M10	51.2	54	61.4	64.8	72	76
M12	89.3	97.6	107.2	117.1	125.7	137.1
M14	142.1	154.5	170.5	185.4	199.5	217.1
M16	221.7	235.9	266	283.1	312	331.4
M18	305.1	343.2	366.1	411.8	429	482.6
M20	432.5	480.2	519	576.2	609.1	675.1
M22	588.4	646.7	706.1	776	827.1	909.8
M24	747.8	813.5	897.4	976.2	1051.3	1143.6
M27	1083.9	1182.1	1312.7	1418.5	1538.3	1662.2



## Maintenance Procedure 7 – Renew Hydraulic Fluid

Hydraulic fluid is hygroscopic and over time will absorb water. Contaminated fluid will reduce the performance of the hydraulic system. Frequent changes of the fluid, see schedule, are essential to maintain optimum performance.

During the change procedure old fluid must be drained from the hydraulic fluid tank. A suitable container, with a capacity of approximately 100 litres, will be required to drain the fluid into. The container will be positioned underneath the vehicle and must be shallow enough to fit in the space available.

**Note: The following hydraulic fluid change procedure must be carried out with all hydraulic cylinders in the closed position.**

- 1) Ensure PTO is disengaged.
- 2) Shut off the stop cock on the hydraulic fluid suction line. The stop cock is located underneath the hydraulic fluid tank (see fig 7.1).
- 3) Disconnect the suction line at the hydraulic pump, located on the back of the PTO (see fig 7.2).
- 4) Position the detached end of the suction line in the container into which the old fluid will be drained.
- 5) Remove the hydraulic tank filler cap (see fig 7.3).
- 6) Open the stop cock on the hydraulic fluid suction line. The hydraulic fluid will drain from the tank into the container.
- 7) When the hydraulic fluid tank is empty shut off the suction line stop cock.
- 8) Re-connect the suction line to the hydraulic pump.
- 9) Fill the tank with new hydraulic fluid to the recommended specification. The tank should be filled to the maximum line on the tank sight gauge (see fig 7.4).
- 10) Re-place the tank filler cap.



Fig 7.1  
Stop Cock



Suction Tube  
Fig 7.2  
Suction Tube



Fig 7.3  
Filler Cap



Fig 7.4  
Hydraulic Tank  
Site Gauge

After completing the fluid change clean up any spilt hydraulic fluid. Old fluid must be disposed of responsibly.

## 11. EC Declaration of Conformity

We: Boughton Engineering Limited

Of: Balliol Business Park,  
Wobaston Road,  
Wolverhampton.  
WV5 9EU.  
United Kingdom

*Hereby declare that:*

Equipment: Power Reach Skiploader System &  
Power Reach Skiploader with Intacova  
Sheeting System

Model number: PR 18 & PR 18 + Intacova

Serial Number :

*complies with all applicable essential requirements of the Machinery Directive 2006/24/EC.*

Signed: 

Name: Carl Holroyd

Position: Engineering Director

Location: Wolverhampton, United Kingdom.

Date: 2 September 2013

*The technical file for the machinery covered by this directive is available from:*

Name: Carl Holroyd

Address: Balliol Business Park,  
Wobaston Road,  
Wolverhampton.  
WV5 9EU.  
United Kingdom

Document No: BEL-PR18-DC

## 12. Further Information

For further information or assistance in operating the PR18 Skiploader and Intacova Sheeting System contact:-

Boughton Engineering Ltd,  
Balliol Business Park,  
Wobaston Road,  
Wolverhampton.  
WV5 9EU.

Tel: +44 (0) 1902 623430

Fax: +44 (0) 1902 787265

Email: [enquiries@boughtonengineering.com](mailto:enquiries@boughtonengineering.com)

