

PRODUCT OVERVIEW

2017



General information

We make life easier for users by constantly developing systems with high reliability and long life.

Our products undergo a corrosion resistant finish* in several steps. All products are approved to meet all national and international standards for their markets.

Warranty

The warranty is valid for 24 months from the date of delivery unless otherwise stated. The warranty only covers manufacturing or material and does NOT cover normal wear and tear.

Products for which a claim is made will not be replaced if they show evidence of damage resulting from incorrect handling or installation. This also covers, for example, damage due to reversing, driving into ditch, jack-knifing, overloading and modifications such as drilling or welding. The warranty does not cover liability in any form for direct or indirect damages for personal injury or damage to property, or for downtime or loss of use and interruption to operations. VBG's products are type approved and therefore it is prohibited to make any modifications.

Other sales conditions can be found in current valid pricelist.

The coupling equipment must be checked regularly or after extreme traffic situations such as reversing, collision, leaving the road or jack-knifing or overloading according to VBG Driver's Manual. If there is any doubt regarding damage or overloading, the coupling equipment must be replaced.

*Exception is the Automatic drawbar 26-100000 and Sliding underrun protection URSP which has an alternative anti-corrosion treatment.

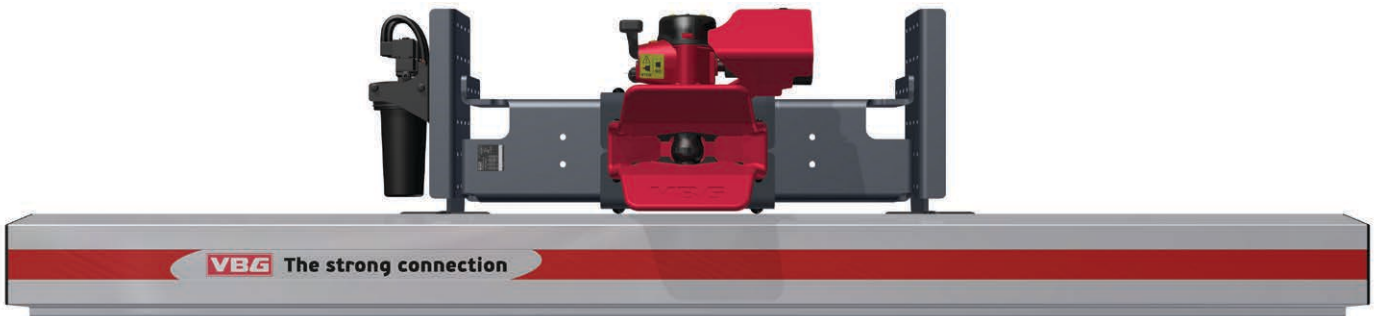

Product Overview Coupling Equipment 2017

© VBG GROUP TRUCK EQUIPMENT AB

Edition g, 2017-01-20

The contents in this publication may not be reproduced either in full, or in part, without the prior approval of VBG GROUP TRUCK EQUIPMENT AB in writing. This prohibition is applicable for all forms of reproductions in all types of media, including electronic media.

VBG GROUP TRUCK EQUIPMENT AB reserve the right to amend or alter specifications at their discretion.

Couplings	4
MFC	10
Accessories	11
Manual couplings	14
Drawbeams	16
Endplate kits	20
Brackets for power and air	26
Underrun protection	27
Screw kits/Spacers	33
Drawbars	34
Accessories	36
Drawbar eyes	39
Power plugs	43
Flexible cables	44
Special oils	46
Rear marker plates	47

Symbol explanation

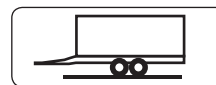

Coupling intended for centre axle trailers, dollies and twin steering axle trailers.



Coupling intended only for twin steering axle trailers with articulated drawbar.

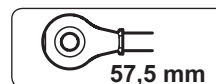

Specifies the size of the coupling bolt/ drawbar eye.

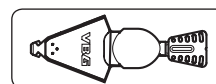

MFC drawbar wedge

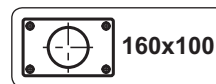

Mounting dimensions for coupling and hole pattern in drawbeam.

Couplings

Specifications

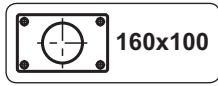
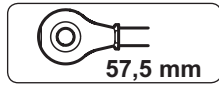
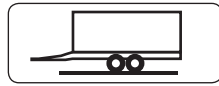

D 190 kN
D_c 120 kN
V 50 kN
S 1000 kg
 EU coupling class S
 Type approval no:
 E4*55R-010063



VBG 750V

Part no...... **09-052500**
Weight 58 kg

D 190 kN
D_c 120 kN
V 50 kN
S 1000 kg
 EU coupling class S
 Type approval no:
 E4*55R-010063



VBG 750V AM

Part no...... **09-030050**
Weight 59 kg
 Control box, indicating kit and cabling is ordered separately,
 see Accessories Couplings.

D 190 kN
D_c 120 kN
V 50 kN
S 1000 kg
 EU coupling class S
 Type approval no:
 E4*55R-010063



VBG 750V PA

Part no...... **09-101700**
Weight 66 kg
 Control box, indicating kit and cabling is ordered separately,
 see Accessories Couplings.

	Alt. 1	Alt. 2
D (kN)	290	290
D_c (kN)	145	150
V (kN)	95	75
S (kg)	1000	2000

EU coupling class S
 Type approval no:
 E4*55R-010065



VBG 795V-2.....Part no

Coupling with short guiding funnel lips incl. screw kit.. **09-255000**
 Coupling with short and long guiding
 funnel lip incl. screw kit.....**09-255100**
 Coupling with long guiding funnel lips incl. screw kit .. **09-255200**
Weight 60 kg

	Alt. 1	Alt. 2
D (kN)	290	290
D_c (kN)	145	150
V (kN)	95	75
S (kg)	1000	2000

EU coupling class S
 Type approval no:
 E4*55R-010065



VBG 795V-2 AM.....Part no

Coupling with short guiding funnel lips incl. screw kit.. **09-255300**
 Coupling with short and long guiding
 funnel lip incl. screw kit..... **09-255400**
 Coupling with long guiding funnel lips incl. screw kit .. **09-255500**
Weight 62kg
 Control box, indicating kit and cabling is ordered separately,
 see Accessories Couplings.

	Alt. 1	Alt. 2
D (kN)	290	290
D_c (kN)	145	150
V (kN)	95	75
S (kg)	1000	2000

EU coupling class S
 Type approval no:
 E4*55R-010065



VBG 795V-2 PA.....Part no

Coupling with short guiding funnel lips incl. screw kit.. **09-255600**
 Coupling with short and long guiding
 funnel lip incl. screw kit..... **09-255700**
 Coupling with long guiding funnel lips incl. screw kit .. **09-255800**
Weight 67kg
 Control box, indicating kit and cabling is ordered separately,
 see Accessories Couplings.

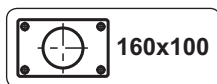
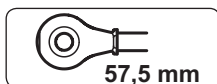
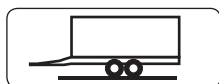

Specifications



VBG 795VR-2 **Part no**
 Coupling with short guiding funnel lips incl. screw kit... **09-256100**
 Coupling with short and long guiding
 funnel lip incl. screw kit **09-256200**
 Coupling with long guiding funnel lips incl. screw kit .. **09-256300**
 Weight 62 kg

	Alt. 1	Alt. 2
D (kN)	290	290
D_c (kN)	145	150
V (kN)	95	75
S (kg)	1000	2000
EU coupling class S		
Type approval no: E4*55R-010065		



VBG 795VR-2 AM **Part no**
 Coupling with short guiding funnel lips incl. screw kit.. **09-256400**
 Coupling with short and long guiding
 funnel lip incl. screw kit **09-256500**
 Coupling with long guiding funnel lips incl. screw kit .. **09-256600**
 Weight 62 kg
 Control box, indicating kit and cabling is ordered separately,
 see Accessories Couplings.

	Alt. 1	Alt. 2
D (kN)	290	290
D_c (kN)	145	150
V (kN)	95	75
S (kg)	1000	2000
EU coupling class S		
Type approval no: E4*55R-010065		



VBG 795VR-2 PA **Part no**
 Coupling with short guiding funnel lips incl. screw kit.. **09-256700**
 Coupling with short and long guiding
 funnel lip incl. screw kit **09-256800**
 Coupling with long guiding funnel lips incl. screw kit .. **09-256900**
 Weight 67 kg
 Control box, indicating kit and cabling is ordered separately,
 see Accessories Couplings.

	Alt. 1	Alt. 2
D (kN)	290	290
D_c (kN)	145	150
V (kN)	95	75
S (kg)	1000	2000
EU coupling class S		
Type approval no: E4*55R-010065		

Couplings

Specifications

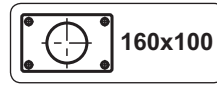
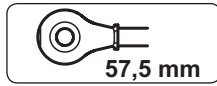

D 200 kN
EU coupling class S
Type approval no:
E4*55R-010064

Angular displacement
for eye
Horizontally $\pm 110^\circ$
Vertically $\pm 30^\circ$
Axially $\pm 40^\circ$



VBG 760

Part no. **05-075500**
Weight 44 kg

D 200 kN
EU coupling class S
Type approval no:
E4*55R-010064

Angular displacement
for eye
Horizontally $\pm 110^\circ$
Vertically $\pm 30^\circ$
Axially $\pm 40^\circ$



VBG 760 AM

Part no. **09-031450**
Weight 49 kg
Control box, indicating kit and cabling is ordered separately,
see Accessories Couplings.

D 200 kN
EU coupling class S
Type approval no:
E4*55R-010064

Angular displacement
for eye
Horizontally $\pm 110^\circ$
Vertically $\pm 30^\circ$
Axially $\pm 40^\circ$



VBG 760 PA

Part no. **09-101800**
Weight 55 kg
Control box, indicating kit and cabling is ordered separately,
see Accessories Couplings.

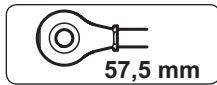

D 310 kN
EU coupling class S
Type approval no:
E11*55R-016804



VBG 7310D-2 **Det. nr**
Coupling with short guiding funnel lips incl. screw kit.. **09-257000**
Weight 93 kg

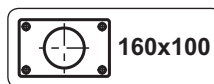
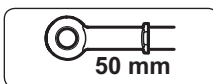

VBG 575V-2

Part no.....**09-070100**

Weight 57,2 kg

D 200 kN
D_c 130 kN
V 75 kN
S 1000 kg
 EU coupling class C50-X
 Type approval no:
 E11*55R-018247



VBG 575V-2 AM

Part no.....**09-072600**

Weight 59,2 kg

Control box, indicating kit and cabling is ordered separately,
 see Accessories Couplings.

D 200 kN
D_c 130 kN
V 75 kN
S 1000 kg
 EU coupling class C50-X
 Type approval no:
 E11*55R-018247



VBG 575V-2 PA

Part no.....**09-072200**

Weight 64,2 kg

Control box, indicating kit and cabling is ordered separately,
 see Accessories Couplings.

D 200 kN
D_c 130 kN
V 75 kN
S 1000 kg
 EU coupling class C50-X
 Type approval no:
 E11*55R-018247



VBG 590VR-2

Part no.....**09-072300**

Weight 61,7 kg

	Alt. 1	Alt. 2
D (kN)	285	285
D_c (kN)	140	130
V (kN)	90	63
S (kg)	1000	2000

EU coupling class C50-X
 Type approval no:
 E11*55R-018476

Couplings

Specifications

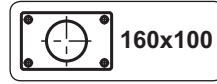
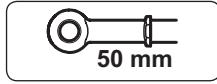

D 190 kN
 EU coupling class C50-X
 Type approval no:
 E4*55R-010067
 Angular displacement
 for eye
 Horizontally ± 90°
 Vertically ± 25°
 Axially ± 40°



VBG 8500
 Part no. **08-009000**
 Weight 38 kg

D 190 kN
 EU coupling class C50-X
 Type approval no:
 E4*55R-010067
 Angular displacement
 for eye
 Horizontally ± 90°
 Vertically ± 25°
 Axially ± 40°



VBG 8500 AM
 Part no. **09-031150**
 Weight 42 kg
 Control box, indicating kit and cabling is ordered separately,
 see Accessories Couplings.

D 190 kN
 EU coupling class C50-X
 Type approval no:
 E4*55R-010067
 Angular displacement
 for eye
 Horizontally ± 90°
 Vertically ± 25°
 Axially ± 40°



VBG 8500 PA
 Part no. **08-016300**
 Weight 47 kg
 Control box, indicating kit and cabling is ordered separately,
 see Accessories Couplings.

D 200 kN
 EU coupling class C50-X
 Type approval no:
 E11*55R-016775
 Angular displacement
 for eye
 Horizontally ± 90°
 Vertically ± 25°
 Axially ± 40°



VBG 5190D
 Part no. **09-127500**
 Weight 44 kg

D 200 kN
 EU coupling class C50-X
 Type approval no:
 E11*55R-016775
 Angular displacement
 for eye
 Horizontally ± 90°
 Vertically ± 25°
 Axially ± 40°



VBG 5190D AM
 Part no. **09-128050**
 Weight 43 kg
 Control box, indicating kit and cabling is ordered separately,
 see Accessories Couplings.

D 200 kN
 EU coupling class C50-X
 Type approval no:
 E11*55R-016775
 Angular displacement
 for eye
 Horizontally ± 90°
 Vertically ± 25°
 Axially ± 40°



VBG 5190D PA
 Part no. **09-127700**
 Weight 51 kg
 Control box, indicating kit and cabling is ordered separately,
 see Accessories Couplings.

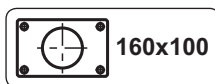
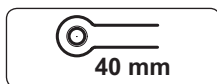

Specifications



VBG 8040

Part no.....**08-020000**

Weight 40 kg

D 136 kN

EU coupling class S

Type approval no:

E4*55R-010066

Angular displacement for eye

Horizontally ± 90°

Vertically ± 45°

Axially ± 40°



VBG 8040 AM

Part no.....**09-124350**

Weight 39 kg

Control box, indicating kit and cabling is ordered separately, see Accessories Couplings.

D 136 kN

EU coupling class S

Type approval no:

E4*55R-010066

Angular displacement for eye

Horizontally ± 90°

Vertically ± 45°

Axially ± 40°

Couplings

Specifications

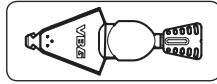

D 188 kN
MFC complies with ECE Regulation R55, class S.

Coupling
E24*55R-010105

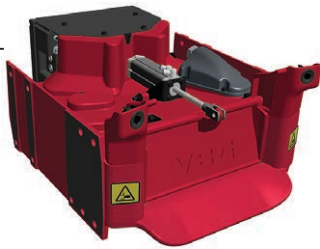

VBG MFC

Weight (kg)

Part no.

Drawbar wedge standard	see drawbar eyes
Coupling unit standard complete.....	107 08-030000
Coupling unit hydraulic complete	109 08-031100
Installation kit	5 28-039000
Installation kit hydraulic.....	20 08-024800

D 188 kN
MFC complies with ECE Regulation R55, class S.

Coupling
E24*55R-010133



VBG AMS-MFC

Weight (kg) Part no.

(VBG MFC, beam system, installation kit, screw kit and cable)

Central installation

Volvo/RVI (400/180/826).....	163 08-033000
Scania (400/150/735).....	158 08-033100
MAN/MB (400/180/730)	157 08-033200
MB 50x50 (400/150/820).....	162 08-034500
Iveco (405/180/742).....	158 08-033400
DAF (420/180/756)	159 08-033300

Central installation, hydraulic

Volvo/RVI (400/180/826).....	185 08-034000
Scania (400/150/735).....	180 08-034100
MAN/MB (400/180/730)	179 08-034200
MB 50x50 (400/150/820).....	184 08-034600
Iveco (405/180/742).....	180 08-034400
DAF (420/180/756)	181 08-034300

D 179 kN
MFC complies with ECE Regulation R55, class S.

Coupling
E24*55R-010107



VBG CMS-MFC

Weight (kg)Part no.

(VBG MFC, beam system, installation kit, screw kit and cable)

Underslung installation

Volvo/RVI (450/418/826).....	205 08-031300
Volvo/RVI, long (650/548/826)	239 08-034700
Scania (450/418/735).....	193 08-031400
Scania, long (650/548/735).....	227 08-034900
MAN/MB (450/418/730)	192 08-031500
Iveco (450/418/742).....	191 08-031700
DAF (420/418/756)	190 08-031600

Underslung installation, hydraulic

Volvo/RVI (450/418/826).....	227 08-033500
Volvo/RVI, long (650/548/826)	261 08-034800
Scania (450/418/735).....	221 08-033600
Scania, long (650/548/735).....	255 08-035000
MAN/MB (450/418/730)	218 08-033700
Iveco (450/418/742).....	220 08-033900
DAF (420/418/756)	221 08-033800



AM unit

For conversion of a manual coupling

to an AM coupling, the following is required:

	Part no.
AM unit	09-124000
Valve box	07-108000
AM operating kit, Duomatic	09-183300
AM operating kit, Palm	09-183200
AM operating kit, C-coupling	09-183400
Position sensor	09-119800
Indicating kit.....	09-099200
Cable kit 12 m.....	09-182600
Cable kit 16 m.....	09-182500
Plug	07-108400

For specifications and performance values, see standard version of respective coupling.

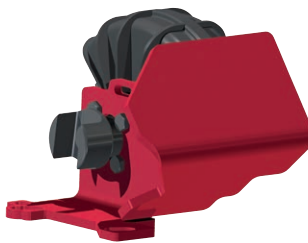

Power actuator

All couplings:

	Part no.
Valve kit	07-108000

VBG 750V/795V/795V-2/795VR/795VR-2, VBG 760, VBG 8500, VBG 8040, VBG 5190D, VBG 7310D/7310D-2, VBG 575V-2, VBG 590VR-2:

Torsion device	07-110200
Bracket	09-113573

VBG 575V/590V/590VR:

Torsion device	07-110200
Bracket	09-179700

For specifications and performance values, see standard version of respective coupling.

Valve box 07-108000 is ordered separately.



Indicating kit

	Part no.
Indicating kit	09-099200
Type approval no: E24*10R-050610 (09-099400)	
Cabling 12 m	09-182600
(unshielded cable with DIN connector for version 3.0)	
Cabling 16 m	09-182500
(unshielded cable with DIN connector for version 3.0)	
Connector with clips	09-099500
Position sensor	09-119800
Type approval no: e24*72/245*2006/96*1751*00	
Type approval no: E24*10R-052000 (09-115600)	
External buzzer.....	09-099800
Jackknife alarm, complete kit	09-036500
(Lamp/buzzer not included)	



Protective insert

	Part no.
Protective insert VBG 750V/AM/PA, 795V/AM/PA, 795V-2/AM/PA, 795VR/VR-2, 7310D/D-2	09-014500



Protective pouch Part no.
Protective pouch for MFC drawbar wedge **08-108500**



VBG MechMatic
Part no. 24V **07-113000**
Part no. 12V **07-115100**
Weight 2,52 kg

Type approval no.: E5*10R-05142

Cabling 3.0 12 m **09-182600**
alt.
Cabling 3.0 16 m **09-182500**



Guiding funnel Part no.
VBG 795V-2/AM/PA, 795VR-2/AM/PA, 7310D-2
Guiding funnel short lips **09-257500**
Guiding funnel short and long lip **09-257600**
Guiding funnel long lips **09-257700**



Jack knife Indicator
Part no. **07-112073**

For coupling VBG 795V/AM/PA, 795VR ,750V/AM/PA in combination with drawbeam DB 75V, DB 75V-2 and DB C7.



Electrical Jack knife Alarm
Part no. **09-300400**
Electronic jack knife alarm for VBG 750V/AM/PA, 795V/AM/PA, 795V-2/AM/PA, 795VR, 795VR-2/AM/PA, 7310D/7310D-2.

Part no. **09-300500**
Electronic jack knife alarm for VBG 575V-2/AM/PA, 590VR-2.



	Part no.
Handle A (1)	09-123300
Sleeve kit for handle (2)	09-126400
Handle B (3)	09-123400
Ball handle (4)	09-126700

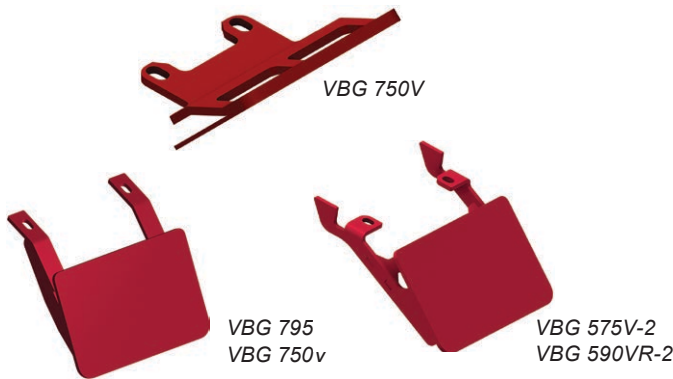

Coupling mouth extender	Part no.
VBG 750V.....	09-058400 + 09-101200
VBG 795V.....	2 pcs. 09-101200
VBG 575V-2/590VR-2	2 pcs. 09-072700



Protective bracket kit	Part no.
VBG 5190D	09-179173
VBG 5190D	09-127973



Protective bracket kit AM	Part no.
VBG 750V/795V/795V-2/795VR-2, VBG760, VBG 8500, VBG 575V-2	09-124973
VBG 8040	09-124773
VBG 575V.....	09-124873



Service tools	Part no.
Service tools couplings (1)	39-030000
Hydraulic foot pump.....	39-031700
Ring spanner for MFC (2).....	08-110400
Mounting tool kit for MFC (3).....	39-033000

Manual couplings

Specifications

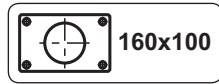

Tow coupling 315

Max tow vehicle weight*:

47.5 tons

Max. centre-axle trailer

weight: 8 tons

Max. trailer weight: 32 tons

Weight: 14 kg

Tow coupling 330

Max tow vehicle weight*:

33.6 tons

Max. centre-axle trailer

weight: 3 tons

Max. trailer weight: 10 tons

Weight: 13 kg

* In accordance with
Directive 77/389/EEG



Tow coupling 315

Part no.07-031500

Weight 14 kg

Hole pattern 160 × 100 mm

Tow coupling 330

Part no.07-033000

Weight 13 kg

Hole pattern 120 × 55 mm

	Weight	Part no.
Coupling bolt VBG Ø 57 mm	2,4 kg	07-031700
Coupling bolt ISO ISO Ø 50 mm	1,8 kg	07-031800
Coupling bolt DIN Ø 40 mm	1,7 kg	07-031900

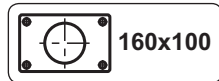

Bolt kit

M20 for hole pattern 160 × 100

Part no. 07-020600

Weight 1,2 kg



Bolt kit

M14 for hole pattern 120 × 55

Part no. 07-020200

Weight 0,5 kg

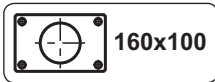

160x100



120x55



Insert adapter

VBG 750V/795V/795V-2/795VR/795VR-2

Part no. **07-111500**
 Hole pattern 160 × 100, 120 × 55 mm
 Weight 6,3 kg

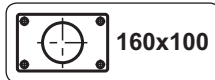

160x100



120x55



Tow jaw 190

Part no. **07-019000**
 Hole pattern: 160 × 100 120 × 55 mm
 Max tow vehicle weight*: 40.7 tons 40.7 tons
 Max. centre-axle trailer weight: 8 tons 3 tons
 Max. trailer weight: 30 tons 10 tons
 Hook diameter: 35 mm 35 mm
 Weight: 5.5 kg 5.5 kg

* In accordance with Directive 77/389/EEG

Accessories **Part no.**
 Cotter for tow jaw 190 **07-035000**



Tow hook 401

Part no. **07-040100**
 Hole pattern: 160 × 100 120 × 55 mm
 Max tow vehicle weight*: 25.4 tons 25.4 tons
 Max. centre-axle trailer weight: 6 tons 3 tons
 Max. trailer weight: 28 tons 10 tons
 Hook diameter: 35 mm 35 mm
 Weight: 6.2 kg 6.2 kg

* In accordance with Directive 77/389/EEG

Accessories **Part no.**
 Lock pin and chain for tow hook 401 **07-039900**



83x56



Ball bracket

Part no. **07-012700**
 Hole pattern 83x56 mm
 Weight: 3,5 kg

D (kN) 31
S (kg) 250
 EU kopplingsklass A50-X
 Typgodkännande nr:
 E4*55R-010606

Bolt kit **Part no.**
 Drawbeam fitted to vehicle frame:
 - total thickness 14-22 mm **21-165100**
 - total thickness 23-30 mm **21-165700**
 Fitting of ball coupling to drawbeam **21-185200**

Spacers
 Thickness 2 mm **21-166100**
 Thickness 4 mm **21-166200**

Drawbeams

Specifications

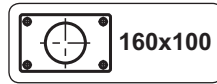

D 138 kN
D_c 92 kN
V 35 kN
S 1000 kg
 EU coupling class F
 Type approval no:
 e11*94/20*3746
 E11 55R-013746



DB 35V

Length (mm)	Weight (kg)	Part no.
728	36	20-097278
742	36	20-097178
752	37	20-097078
770	38	20-096778
784	39	20-096670
834	40	20-096570
850	41	20-095570

	Alt. 1	Alt. 2
D (kN)	200	200
D_c (kN)	130	130
V (kN)	75	63
S (kg)	1000	2000

	Alt. 3	Alt. 4
D (kN)	200	200
D_c (kN)	150	141
V (kN)	50	63
S (kg)	1000	1000

EU coupling class F
 Type approval no:
 E11*55R-018244



DB 75V-2 60x60

Length (mm)	Weight (kg)	Part no.
590	38	20-108378
728	43	20-108178
742	43,5	20-111278
752	44	20-107978
756	44,5	20-110878
762	44	20-107778
766	44,5	20-111078
770	44,5	20-107578
784	45	20-107378
790	45,5	20-151278
826	46,5	20-107178
850	47,5	20-106978
885	49	20-106778

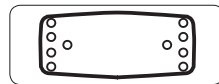

D 260 kN
 Type approval no:
 E11 *55R-015341



DB 260D

Length (mm)	Weight (kg)	Part no.
735	58	20-103178
766	59	20-100300
825	60	20-102870
834	61	20-099900



D 41 kN
D_c 30 kN
V 18 kN
S 350 kg
 EU coupling class F
 Type approval no:
 E11 *55R-016701



TB 30D

Length (mm)	Weight (kg)	Part no.
752	17,0	21-166078
770	17,5	21-165978
834	18,9	21-165878
850	19,5	21-165278

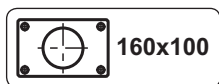

Specifications



DB-C7 DAF 60x60

For central and semi-underslung installation

Length (mm)	Weight (kg)	Part no.
756	45,5	20-105278
766	46,0	20-105378

Endplate EDS

Part no.	20-112078
Weight	15,0 kg
Bolt kits/spacers	see www.vbg.eu

	Alt. 1	Alt. 2
D (kN)	200	200
D _c (kN)	140	141
V (kN)	75	63
S (kg)	1000	2000
Alt. 3		
D (kN)	200	
D _c (kN)	150	
V (kN)	50	
S (kg)	1000	
EU coupling class F		
Type approval no: E11*55R-018246		

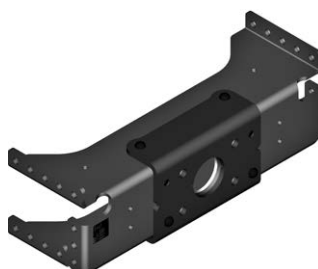

DB-C7 Iveco 45x45

For central and semi-underslung installation

Length (mm)	Weight (kg)	Part no.
742	45,5	20-105678
756	46,0	20-110678

Endplate EDS

Part no.	20-112178
Weight	13,0 kg
Bolt kits/spacers	see www.vbg.eu

	Alt. 1	Alt. 2
D (kN)	200	200
D _c (kN)	140	141
V (kN)	75	63
S (kg)	1000	2000
Alt. 3		
D (kN)	200	
D _c (kN)	150	
V (kN)	50	
S (kg)	1000	
EU coupling class F		
Type approval no: E11*55R-018246		

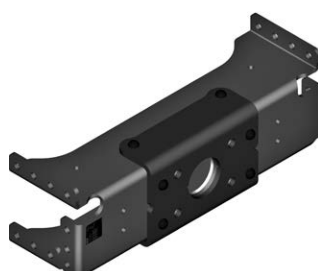

DB-C7 MAN 50x50/40

For central and semi-underslung installation

Length (mm)	Weight (kg)	Part no.
730	43,5	20-104878
744	44,0	20-104978

Endplate EDS

Part no.	20-111978
Weight	12,0 kg
Bolt kits/spacers	see www.vbg.eu

	Alt. 1	Alt. 2
D (kN)	200	200
D _c (kN)	140	141
V (kN)	75	63
S (kg)	1000	2000
Alt. 3		
D (kN)	200	
D _c (kN)	150	
V (kN)	50	
S (kg)	1000	
EU coupling class F		
Type approval no: E11*55R-018246		

Drawbeams

Specifications

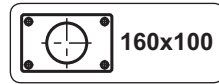

	Alt. 1	Alt. 2
D (kN)	200	200
D_c (kN)	140	141
V (kN)	75	63
S (kg)	1000	2000

	Alt. 3
D (kN)	200
D_c (kN)	150
V (kN)	50
S (kg)	1000

EU coupling class F
Type approval no:
E11*55R-018246

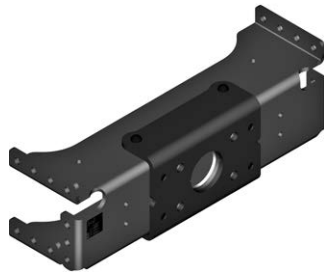

DB-C7 Mercedes 50x50

For central and semi-underslung installation

Length (mm)	Weight (kg)	Part no.
730 (50x45)	43,5	20-111478
744 (50x45)	44,0	20-111578
732	51,5	20-112678
744	52,0	20-112578
822	55,0	20-112478
834	56,0	20-112378

Endplate EDS

Part no. (50x45)	20-111978
Part no.	20-113078
Weight	12,0 kg
Bolt kits/spacers	see www.vbg.eu

	Alt. 1	Alt. 2
D (kN)	200	200
D_c (kN)	140	141
V (kN)	75	63
S (kg)	1000	2000

	Alt. 3
D (kN)	200
D_c (kN)	150
V (kN)	50
S (kg)	1000

EU coupling class F
Type approval no:
E11*55R-018246



DB-C7 Scania 50x50

For central and semi-underslung installation

Length (mm)	Weight (kg)	Part no.
751	43,5	20-103978
735	42,5	20-104178

Endplate EDS

Part no.	21-112278
Weight	21,0kg
Bolt kits/spacers	see www.vbg.eu

	Alt. 1	Alt. 2
D (kN)	200	200
D_c (kN)	140	141
V (kN)	75	63
S (kg)	1000	2000

	Alt. 3
D (kN)	200
D_c (kN)	150
V (kN)	50
S (kg)	1000

EU coupling class F
Type approval no:
E11*55R-018246



DB-C7 Volvo/RVI 50x60

For central and semi-underslung installation

Length (mm)	Weight (kg)	Part no.
826	46,5	20-104278
836	47,0	20-104378

Endplate EDS

Part no.	20-111878
Weight	13,0 kg
Bolt kits/spacers	see www.vbg.eu

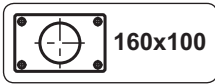

Specifications



CMS 63V

Length (mm)	Weight (kg)	Part no.
735 (H=175)	103	21-205478
826 (H=175)	111	21-207178
826 (H=255)	127	21-584978

D 166 kN
D_c 141 kN
V 63 kN
S 1000 kg
 EU coupling class F
 Type approval no:
 E24*55R-010264

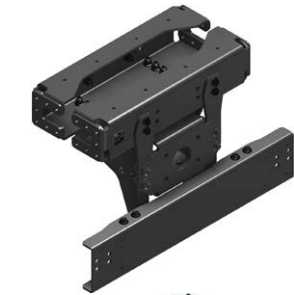

CMS 63V EU

Length (mm)	Weight (kg)	Part no.
735 (H=175)	141	21-206278
826 (H=175)	149	21-207278
826 (H=255)	166	21-585578

D 166 kN
D_c 141 kN
V 63 kN
S 1000 kg
 EU coupling class F
 Type approval no:
 E24*55R-010264

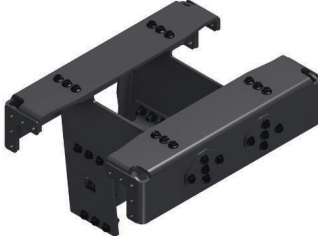

CMS DBI

Length (mm)	Weight (kg)	Part no.
730	122	21-199678
735	122	21-199478
742	123	21-199878
756	125	21-199778
826	128	21-199578

D 141 kN
D_c 141 kN
V 63 kN
S 1000 kg
 EU coupling class F
 Type approval no:
 E24*55R-010002



CMS Trailer incl. drawbeam

L Cross member (mm)	Coupling height (mm)	Weight (kg)	Part no.
958-974	290	161	21-208578
958-974	450	181	21-208778
1078-1094	290	174	21-196278
1078-1094	450	194	21-196678
1178-1194	290	183	21-208478
1178-1194	450	203	21-208678
1278-1294	290	192	21-196178
1278-1294	450	212	21-196578

D 141 kN
D_c 141 kN
V 63 kN
S 1000 kg
 EU coupling class F
 Type approval no:
 E24*55R-010155

Endplate kits

Specifications

Performance values
see respective drawbeam
Type approval no
see respective drawbeam

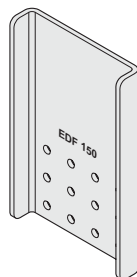

EDF 150

Endplate kit for vehicle-adapted holing.

Part no. (275x460)**21-588278**
Weight 22,0 kg
Bolt kits/spacers see www.vbg.eu

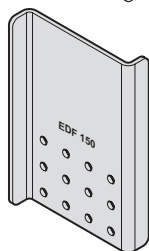

EDF 150 Tipper

Endplate kit for vehicle-adapted holing.

Part no. (275x460)**21-588578**
Weight 22,0 kg
Bolt kits/spacers see www.vbg.eu

Performance values
see drawbeam TB 30D
Type approval no
see drawbeam TB 30D

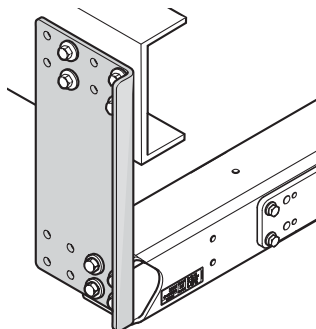

EDH-2T

Part no.**21-112378**
Weight 30 kg

Screw kit (M16) for fitting endplate kit to vehicle frame:

TB 30D **Part no.**
14-22 mm **21-165100**
23-30 mm **21-165700**

Performance values
see respective drawbeam
Type approval no
see respective drawbeam

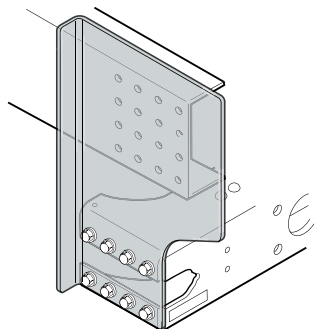

EDK

Long, part no.**21-131600**
Short, part no.**21-132700**
Weight the weight varies, depending
on the size of endplate

Screw kit for fitting endplate kit to vehicle frame:

DB 35V, DB 75V **Part no.**
If the flange is fitted at front **21-149500**
If the flange is fitted at back 2x **21-148800**

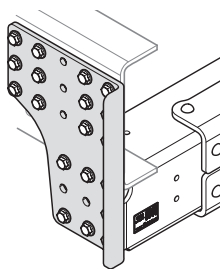

EDH-3 DAF 60x60

Part no. 21-214278
Weight 16,7 kg
Bolt kits/spacers see www.vbg.eu

Performance values
see respective drawbeam
Type approval no
see respective drawbeam

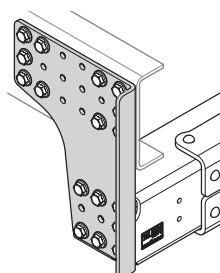

EDM-2 DAF 60x60

Part no. 21-221178
Weight 23,6 kg
Bolt kits/spacers see www.vbg.eu

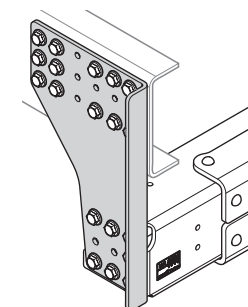

EDL-2 DAF 60x60

Part no. 21-223278
Weight 31,0 kg
Bolt kits/spacers see www.vbg.eu

Endplate kits

Specifications

Performance values
see respective drawbeam
Type approval no
see respective drawbeam

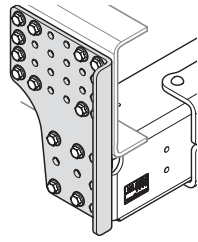

EDH-3 IVECO 45x45

Part no.21-214578
Weight 16,7 kg
Bolt kits/spacers see www.vbg.eu

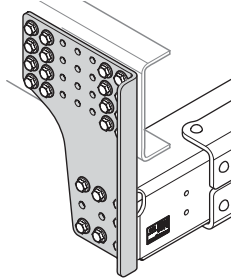

EDM-2 IVECO 45x45

Part no.21-221478
Weight 23,4 kg
Bolt kits/spacers see www.vbg.eu

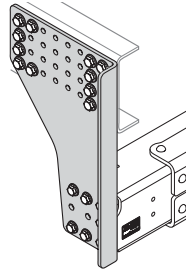

EDL-2 IVECO 45x45

Part no.21-223578
Weight 32,0 kg
Bolt kits/spacers see www.vbg.eu

Performance values
see respective drawbeam
Type approval no
see respective drawbeam

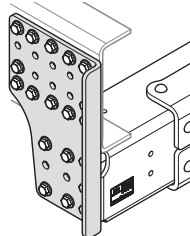

EDH-3 MAN 50x50/40

Part no.21-213078
Weight 16,5 kg
Bolt kits/spacers see www.vbg.eu

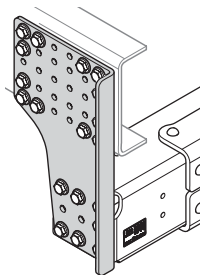

EDM-2 MAN 50x50/40

Part no.21-220278
Weight 25,3 kg
Bolt kits/spacers see www.vbg.eu

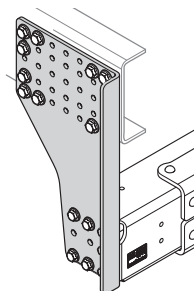

EDL-2 MAN 50x50/40

Part no.21-222378
Weight 34,6 kg
Bolt kits/spacers see www.vbg.eu

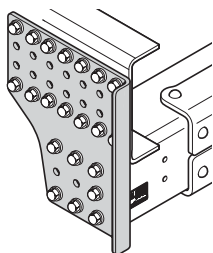

EDH-2 MB 50x50

Part no. 21-208178
 Weight 23,0 kg
 Bolt kits/spacers see www.vbg.eu

Performance values
 see respective drawbeam
 Type approval no
 see respective drawbeam

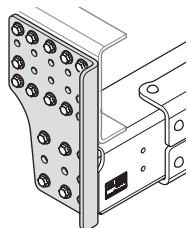

EDH-3 Mercedes 50x45

Part no. 21-213378
 Weight 16,5 kg
 Bolt kits/spacers see www.vbg.eu

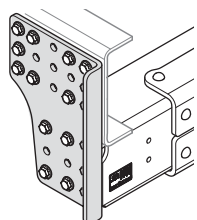

EDH-3 Mercedes 50x50

Part no. 21-214878
 Weight 16,5 kg
 Bolt kits/spacers see www.vbg.eu

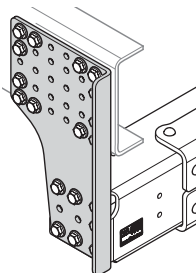

EDM-2 Mercedes 50x45

Part no. 21-220578
 Weight 25,0 kg
 Bolt kits/spacers see www.vbg.eu

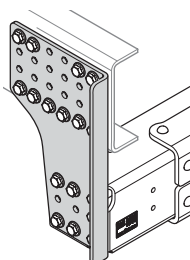

EDM-2 Mercedes 50x50

Part no. 21-220878
 Weight 23,8 kg
 Bolt kits/spacers see www.vbg.eu

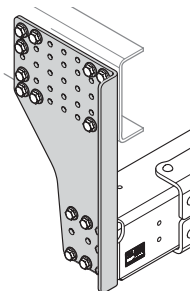

EDL-2 Mercedes 50x45

Part no. 21-222678
 Weight 34,6 kg
 Bolt kits/spacers see www.vbg.eu

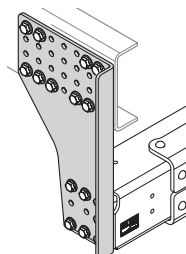

EDL-2 Mercedes 50x50

Part no. 21-222978
 Weight 32,6 kg
 Bolt kits/spacers see www.vbg.eu

Specifications

Performance values
see respective drawbeam
Type approval no
see respective drawbeam

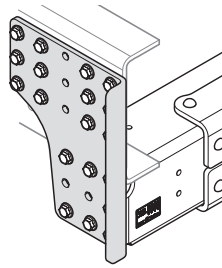

EDH-3 SCANIA 50x50

Part no.21-213678
Weight 16,7 kg
Bolt kits/spacers see www.vbg.eu

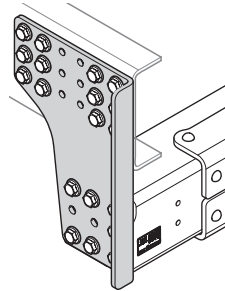

EDM-2 SCANIA 50x50

Part no.21-219678
Weight 21,0kg
Bolt kits/spacers see www.vbg.eu

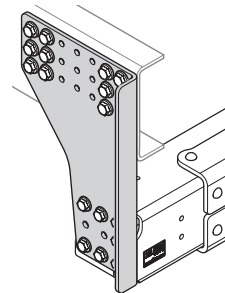

EDL-2 SCANIA 50x50

Part no.21-221778
Weight 29,5 kg
Bolt kits/spacers see www.vbg.eu

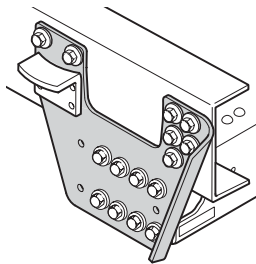

EDHZ 50x50

Part no.21-167378
Weight 16,0 kg
Bolt kits/spacers see www.vbg.eu

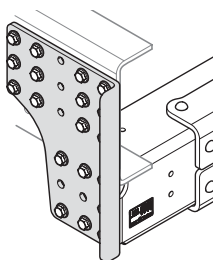

EDH-3 VOLVO/RVI 50x60

Part no.21-213978
 Weight 16,7 kg
 Bolt kits/spacers see www.vbg.eu

Performance values
 see respective drawbeam
 Type approval no
 see respective drawbeam

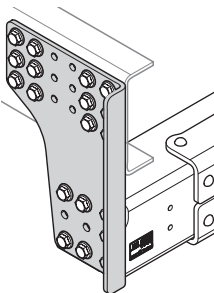

EDM-2 VOLVO/RVI 50x60

Part no.21-219978
 Weight 22,2 kg
 Bolt kits/spacers see www.vbg.eu

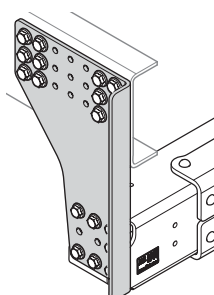

EDL-2 VOLVO/RVI 50x60

Part no.21-222078
 Weight 31,0 kg
 Bolt kits/spacers see www.vbg.eu

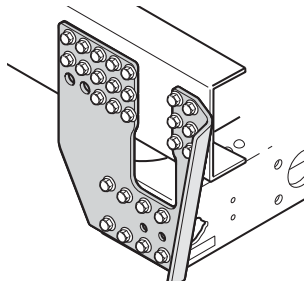

EDMS-2 50x60

Part no.21-164278
 Weight 37 kg
 Bolt kits/spacers see www.vbg.eu

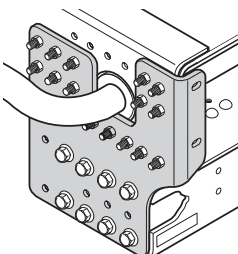

EDC-1 50x60

Part no.
 for standard bogie installation height..... 21-147500
 for high/extra high bogie installation height 21-147400
 Weight 78 kg
 Bolt kits/spacers see www.vbg.eu

Brackets for power and air



Installation beam

L=826 mm

Part no.21-179170

incl.

1 Duomatic bracket21-179478

2 Power plug brackets.....21-179378

12 M6SF screws

12 M6MF nuts

Weight 18 kg



L=734 mm

Part no.21-179278

incl.

1 Duomatic bracket21-179478

2 Power plug brackets.....21-179378

12 M6SF screws

12 M6MF nuts

Weight 18 kg



Holder for power plug

Part no.21-179378

incl. 4 M6SF screws, 4 M6MF nuts

Weight 0,33 kg



Holder for Duomatic

Part no.21-179478

incl. 4 M6SF screws, 4 M6MF nuts

Weight 0,41 kg



Holder for hydraulic plug

Part no.21-179578

incl. 4 M6SF screws, 4 M6MF nuts

Weight 0,38 kg



Cover plate

Part no.21-179678

incl. 4 M6SF screws, 4 M6MF nuts

Weight 0,44 kg



Spacer 5 mm (4 st).....21-192700

Weight 1,5 kg

Spacer 8 mm (4 st).....21-192800

Weight 2,3 kg



Bracket

Left, part no.28-045778

Weight 3,0 kg

Right, part no.28-045878

Weight 3,0 kg



Bracket

Underlying, part no.28-045978

Weight 3,2 kg

Aluminium beam

UHAP-2



Protective beam	Intended for frame width		Length (mm)	Weight (kg)	Part no.
	B1 (mm)	B2 (mm)			
UHAP-2	760-1300 ...	760-1300 ..	2400 ...	20	21-210800
UHAP-2	760-1300 ...	760-1300 ..	2400 ...	20	21-210700 with reflex
UHAP-2	760-1300 ...	760-1300 ..	1900 ...	16	21-210900
UHAP-2	760-1300 ...	760-1300 ..	2400 ...	20	21-595000

Type approval no.:
E11*58R-025001

Steel beam

UOSP



Protective beam	Intended for frame width		Length (mm)	Weight (kg)	Part no.
	B1 (mm)	B2 (mm)			
UOSP	760-850 ...	760-850 ...	2358 ...	25,5 ..	21-176978

Type approval no.:
E11*58R-02010002

UCSP



Protective beam	Intended for frame width		Length (mm)	Weight (kg)	Part no.
	B1 (mm)	B2 (mm)			
UCSP	640-1300 ...	640-1300 ..	2314 ...	18 ...	21-177270
UCSP	640-1300 ...	640-1300 ..	2314 ...	18 ...	21-177278
UCSP	640-1300 ...	640-1300 ..	1914 ...	15 ...	21-177578

Type approval no.:
E11*58R-02010003

UDSP



Protective beam	Intended for frame width		Length (mm)	Weight (kg)	Part no.
	B1 (mm)	B2 (mm)			
UDSP	754-852	2412	52,9	21-580678

Type approval no.:
E11*58R-0211516

Spacer for UDSP

Thickness	Weight (kg)	Part no.
6 mm	0,36	21-584700
8 mm	0,49	21-584600
10 mm	0,61	21-584200
14 mm	0,85	21-584300
16 mm	1,00	21-584400

Sliding underrun protection

URSP



Type	Length L (mm)	Weight (kg)	Part no.
URSP, 600 mm manual	661	83	21-224600
URSP, 1000 mm manual	1061	92	21-224700
URSP, 600 mm hydraulic	661	92	21-192200
URSP, 1000 mm hydraulic	1061	101	21-192300

Type approval no.:
E11*58R-0210206

Underrun protection

Bracket for protective beam

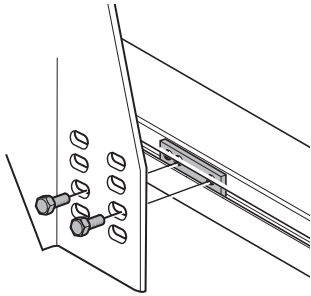

Part no. **21-175000**
Weight 1 kg

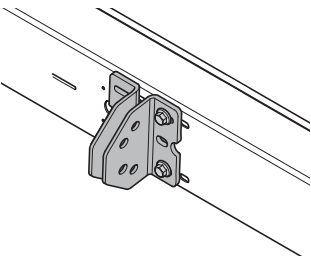

Part no. **21-175178**
Weight 7,3 kg

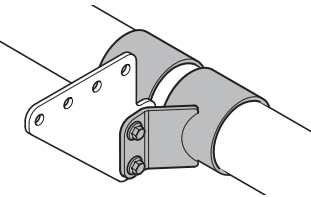

Part no. **21-178478**
Weight 10,6 kg

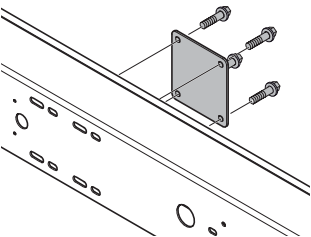

Part no. **21-178378**
Weight 1,7 kg

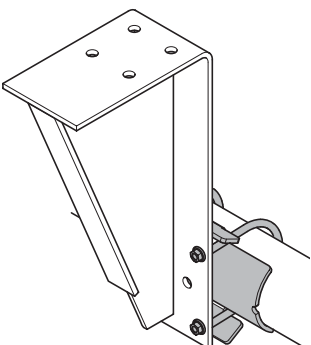

Part no. **21-183478**
Weight 5,7 kg

Endplate Kits

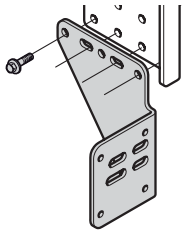

EUS-4 45/60

Part no.21-225678

Weight 7,6 kg

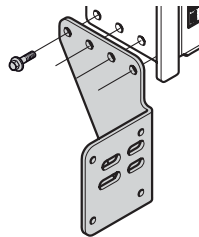

EUS-4 50

Part no.21-570778

Weight 7 kg

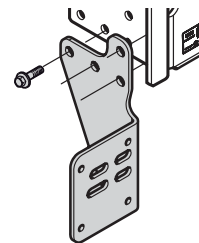

EUS-4 60

Part no.21-225378

Weight 7,6 kg

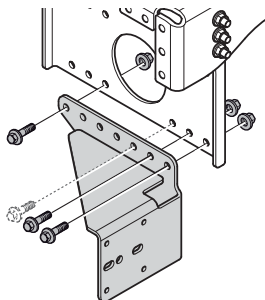

EUS-MFC

Part no.21-184678

Weight 16,7 kg

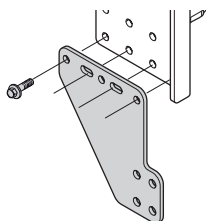

EUP 45/60

Part no. H=19521-212278

Weight 6 kg

Part no. H=13521-212578

Weight: 5 kg

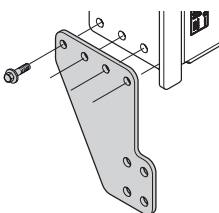

EUP 50

Part no. H=19521-570478

Weight 5,5 kg

Part no. H=13521-570578

Weight: 4,5 kg

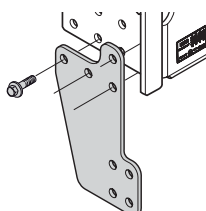

EUP 60

Part no. H=19521-212478

Weight 5,5 kg

Part no. H=13521-212778

Weight: 4,5 kg

Underrun protection

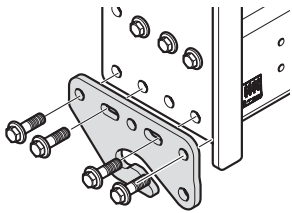

EUR-4 45/60

Part no. 21-230578
Weight 6,7 kg

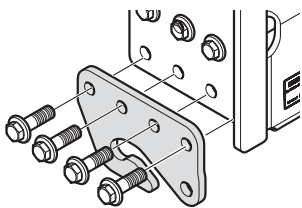

EUR-4 50

Part no. 21-571078
Weight 6,5 kg

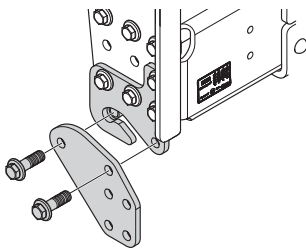

EUR-4 60

Part no. 21-215378
Weight 9 kg

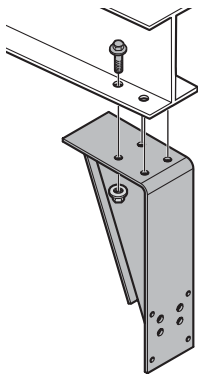

EUT

Part no. 21-086078
Weight 23 kg

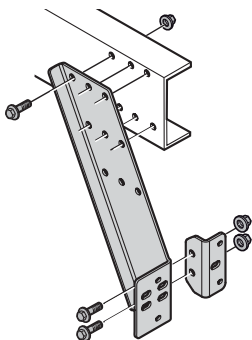

EUL

Part no. 21-186978
Weight 12 kg

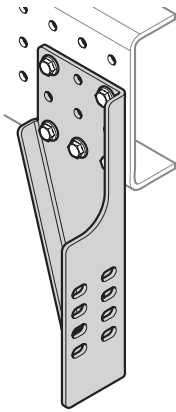

EUH-2 DAF 60x60

Part no.....21-227578
Weight 14,4 kg

EUH-2 Iveco 45x45

Part no.....21-226078
Weight 12,6 kg

EUH-2 MAN/Mercedes 50x45/40

Part no.....21-226978
Weight 12,9 kg

EUH-2 Mercedes 50x50

Part no.....21-226678
Weight 13,2 kg

EUH-2 Scania 50x50

Part no.....21-226378
Weight 13,2 kg

EUH-2 Volvo/RVI 50x60

Part no.....21-227278
Weight 13,6 kg

EUH-3 undrilled endplate

Part no.....21-592378
Weight 14,9 kg

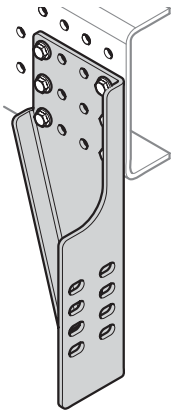

EUM-2 DAF 60x60

Part no.....21-229378
Weight 19,8 kg

EUM-2 Iveco 45x45

Part no.....21-227878
Weight 17,0 kg

EUM-2 MAN/Mercedes 50x45/40

Part no.....21-228778
Weight 17,5 kg

EUM-2 Mercedes 50x50

Part no.....21-228478
Weight 18,0 kg

EUM-2 Scania 50x50

Part no.....21-228178
Weight 17,9 kg

EUM-2 Volvo/RVI 50x60

Part no.....21-229078
Weight 18,5 kg

EUM-3 undrilled endplate

Part no.....21-592678
Weight 22,2 kg

Attaching underrun protection

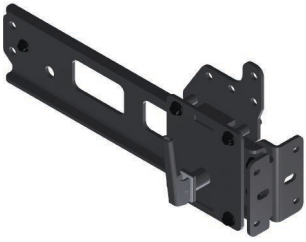

Bracket UPSO-2 50

Part no. 21-571278
Weight 37 kg

Bracket UPSO-2 45/60

Part no. 21-229678
Weight 37 kg

Bracket UPSO-2 60

Part no. 21-225778
Weight 37 kg



Bracket UPS-2

Fits UHAP-2

Part no. 21-230678
Weight 15,5 kg

Fits UCSP

Part no. 21-230778
Weight 12,0 kg



Bracket UPB

Fits UHAP-2, UOSP, UCSP together with end plate CMS
63V EU

Part no (150)..... 21-586578
Weight 11,0 kg

Part no.(100)..... 21-587878
Weight 9,0 kg



Hinged underrun protection

EUF-2

Left, part no. 21-176578

Right, part no. 21-176678

Weight/pair 31 kg

Type approval no See respective protective beam

Accessories

Part no.

Parallel bracket..... 21-179778

Screw kit for truck frame..... 21-182400

Arm stop kit..... 21-187778

EUFA

(Mounting plates, arm kit and tube)

Type	Hole pattern	Weight (kg)	Part no.
EUFA.....	45x45	75,1	21-590278
EUFA.....	50x60	77,0	21-590378
EUFA.....	50x50	75,9	21-590478
EUFA..	undrilled	77,4	21-590578

Accessories

Part no.

Spring kit 21-587500

Adjusting tool..... 39-035100



Bolt kits for thickness 14-27 mm



Description	Weight (kg)	Part no.
50 mm M14, 10.9, 10-pack	1,5	21-202200
50 mm M14, 10.9, 4-pack	0,6	21-202300
50 mm M16, 10.9, 10-pack	2,1	21-204700
50 mm M16, 10.9, 4-pack	0,9	21-204800

Bolt kits for thickness 24-37 mm

Description	Weight (kg)	Part no.
60 mm M14, 10.9, 10-pack	1,6	21-202400
60 mm M14, 10.9, 4-pack	0,6	21-204600
60 mm M16, 10.9, 10-pack	2,3	21-204900
60 mm M16, 10.9, 4-pack	0,9	21-205000

Bolt kits for thickness 36-47 mm

Description	Weight (kg)	Part no.
70 mm M14, 10.9, 10-pack	2,0	21-593900
70 mm M14, 10.9, 4-pack	0,8	21-593800
70 mm M16, 10.9, 10-pack	2,5	21-593700
70 mm M16, 10.9, 4-pack	1,0	21-593600

Spacer for DB75V-2



Thickness	Weight (kg)	Part no.
1 mm	0,14	20-108600
2 mm	0,27	20-108700
5 mm	0,66	20-108800
8 mm	1,06	20-108900
10 mm	1,32	20-109000

Spacer for DB-C7



Thickness	Weight (kg)	Part no.
1 mm	0,06	20-150000
2 mm	0,13	20-150100
5 mm	0,31	20-150200
8 mm	0,49	20-150300
10 mm	0,62	20-150400

Thickness	Weight (kg)	Part no.
1 mm	0,06	20-109600
2 mm	0,12	20-109700
5 mm	0,29	20-109800
8 mm	0,46	20-109900
10 mm	0,58	20-110000

Thickness	Weight (kg)	Part no.
1 mm	0,03	20-150500
2 mm	0,06	20-150600
5 mm	0,12	20-150700
8 mm	0,18	20-150800
10 mm	0,23	20-150900

Drawbars

Specifications

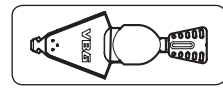
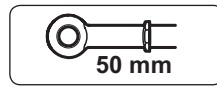
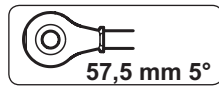
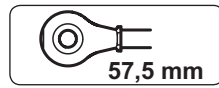

D 188 kN
A_v 18 tons
 Length ≤ 3500 mm
 Type approval no
 E11*55R-014637



Multi XF

Part no. see www.vbg.eu
 Weight see www.vbg.eu

D 162 kN
A_v 18 tons
 Length > 3500 mm
 Type approval no
 E11*55R-014636

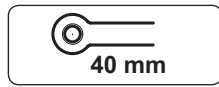

Multi XF

Part no. see www.vbg.eu
 Weight see www.vbg.eu

D 130 kN
A_v 12 tons
 Type approval no
 E11*55R-014978

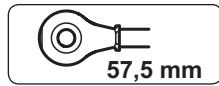

D 179 kN
A_v 18 tons
 Type approval no
 E11*55R-013425



Multi D 179

Part no. see www.vbg.eu
 Weight see www.vbg.eu



D 130 kN
A_v 12 tons
 Type approval no
 E11*55R-012589



Multi D 130

Part no. see www.vbg.eu
 Weight see www.vbg.eu

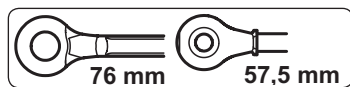

D 158/179 kN
A_v 18 tons
 Type approval no
 E11*55R-018218



Front part Multi D 158/179

Part no. see www.vbg.eu
 Weight see www.vbg.eu



D 158/179 kN
A_v 18 tons
 Type approval no
 E11*55R-018218



Front part Multi D 158/179

Part no. see www.vbg.eu
 Weight see www.vbg.eu

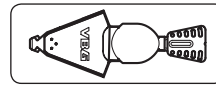
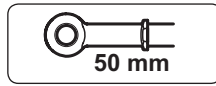
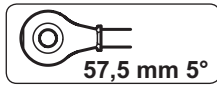
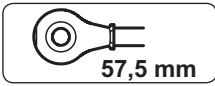

Optimal

Part no.see www.vbg.eu

Weightsee www.vbg.eu

D 188 kN

A_v 18 tons

Length ≤ 3500 mm

Class E

Type approval no

E11*55R-016004

D 162 kN

A_v 18 tons

Length > 3500 mm

Class E

Type approval no

E11*55R-016279



Optimal

Part no.see www.vbg.eu

Weightsee www.vbg.eu

D 130 kN

A_v 12 tons

Class E

Type approval no

E11*55R-016280



Automatic drawbar

Part no. **26-100000**

D 152 kN

A_v 18 tons

Class E

Type approval no

E11*55R-014456

Joint accessories

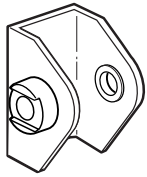

Trailer bracket for Vibra block.....**Part no.**
26-057300



Sleeve for welding of trailer bracket BRIAB.....**25-064800**

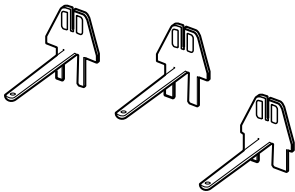

Centering tool for drawbar eye DIN Ø 40 mm**25-055000**
 Centering tool for drawbar eye ISO Ø 50 mm**25-055100**
 Centering tool for drawbar eye VBG Ø 57 mm.....**25-055200**

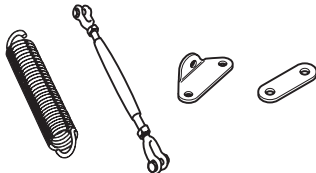

Balancing kit**25-053700**
 (incl. balance spring, rigging screw and spring retainer)

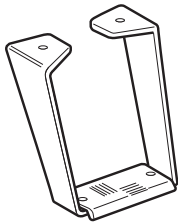

Foot step.....**25-054100**

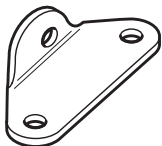

Spring retainer**25-054900**



Holder for power plug.....**18-030100**

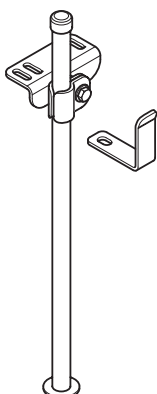

Support.....**25-083778**

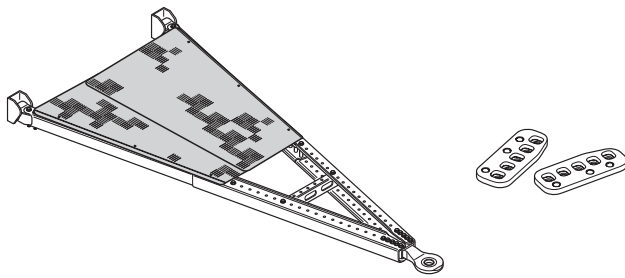

Unique accessories Multi XF

	Part no.
Catwalk.....	25-074300
Mounting plates for MFC Towing adapter	08-106000

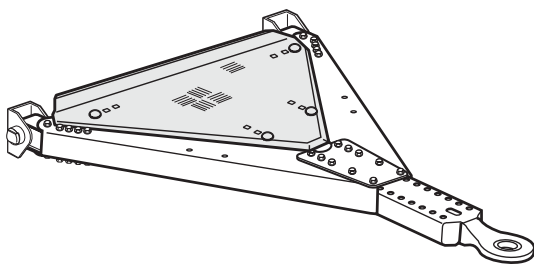

Unique accessories Multi

Part no.

Catwalk, short25-054800

Fits following drawbars:

25-056078	25-059778	25-061678	25-056178
25-060278	25-062178	25-056278	25-060378
25-062278	25-059478	25-061378	25-063178
25-059578	25-061478	25-063278	25-059678
25-061578	25-063578		

Catwalk, medium.....25-054700

Fits following drawbars:

25-044378	25-045378	25-060478	25-044478
25-045478	25-062378	25-044578	25-056378
25-063378	25-044678	25-056478	25-063478
25-045178	25-056578	25-063678	25-045278

Catwalk, long.....25-054600

Fits following drawbars:

25-043978	25-044778	25-045578	25-044078
25-044878	25-045678	25-044178	25-044978
25-045778	25-044278	25-045078	25-045878

Mounting plates for MFC Towing adapter 08-106000

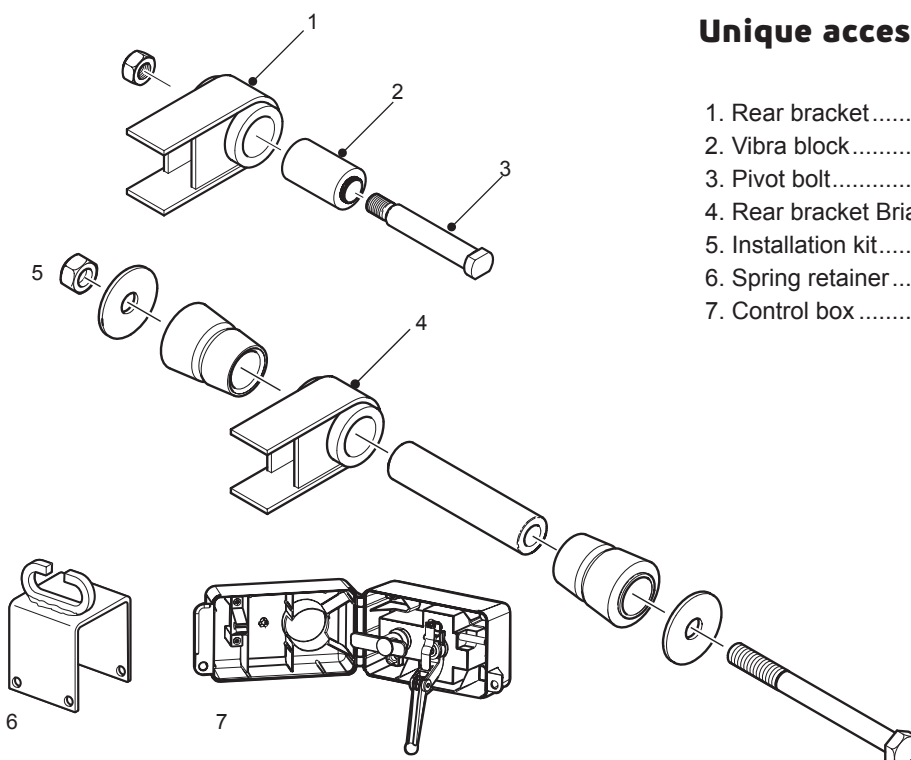





Unique accessories Automatic drawbar

Part no.

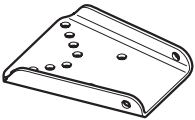
1. Rear bracket.....	25-013000
2. Vibra block.....	26-050700
3. Pivot bolt.....	18-055600
4. Rear bracket Briab.....	25-013500
5. Installation kit.....	26-058600
6. Spring retainer.....	26-071700
7. Control box.....	07-108000

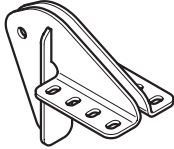
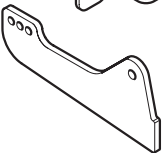
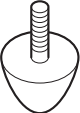
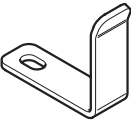
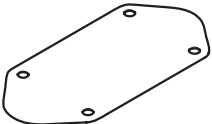
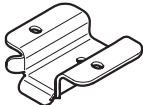
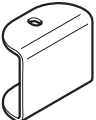
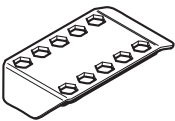
Unique accessories Optimal

	Part no.
	Lifting bracket alt 1 25-088278
	Lifting bracket alt 2 25-087878
	Lifting bracket alt 3 25-089478
	Lifting arm..... 25-089378
	Damper..... 25-088700
	Cable bracket 25-088678
	Cover plate 25-088178
	Cable protection 25-088078
	Bracket for welding 25-087900
	Sliding bracket, front..... 25-108578
	Sliding bracket, rear..... 25-108478
	Mounting plate for MFC Towing adapter..... 08-105900

Specifications

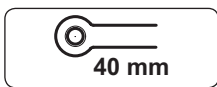

Welded drawbar eyes

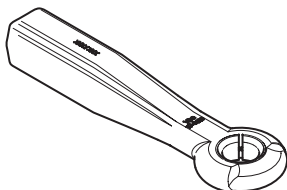

DBE 129

Part no.17-012900
Weight7,3 kg

Total weight 48 tons
Trailer weight 32 tons
Support load 900 kg

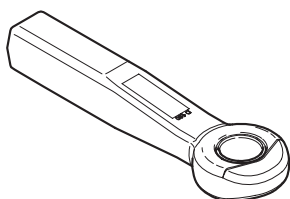
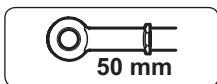

DBE 895

Part no.16-089500
Weight 10 kg

D value 190 kN
Dc value 150 kN
V value 25 kN
Support load 1000 kg
Class D50-X
Type approval no.
E4*55R-010162

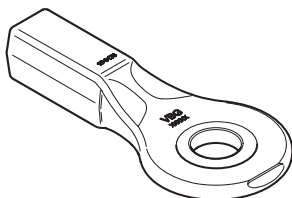
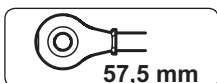

DBE 173

Part no. 15-017300
Weight12,7 kg

D-value 200 kN
Dc-value -
V-value -
Support load -
Class S
Type approval no.
E4*55R-010332

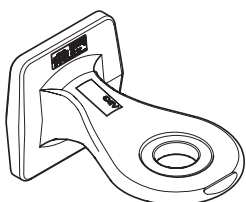

DBE 230

Part no. 15-023000
Weight 19,8 kg

	Alt. 1	Alt. 2
D (kN)	290	290
D _c (kN)	145	150
V (kN)	95	75
S (kg)	1000	2000

Type approval no.
E11*55R-019835

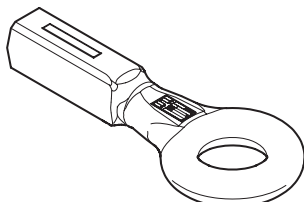
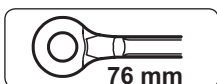

DBE 132

Part no.17-014400
Weight 9,7 kg

D value 190 kN
Dc value -
V value -
Support load -
Type approval no.
E11*55R-017329

Drawbar eyes

Specifications

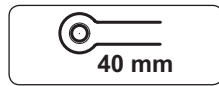

Total weight 48 Ton
Trailer weight 32 Ton
Support load 1000 kg

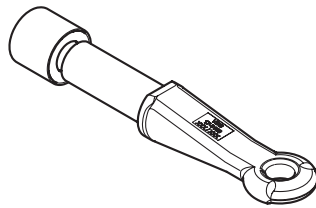

Screwed drawbar eyes

DBE 130

Part no.17-013000
Weight 10,3 kg

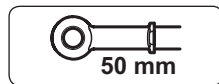

D value 190 kN
Dc value 120 kN
V value 40 kN
Support load 1000 kg

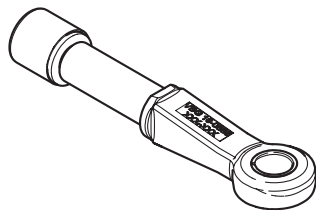

DBE 885

Part no.16-088500
Weight12 kg

Class D50-X
 Type approval no.
 E11*55R-013731

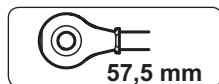

D value 190 kN
Dc value 120 kN
V value 40 kN
Support load 1000 kg

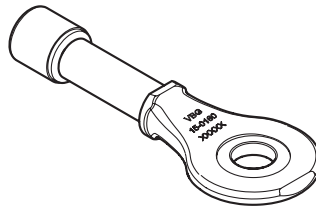

DBE 160

Part no. 15-016000
Weight13 kg

Class S
 Type approval no.
 E4*55R-010319

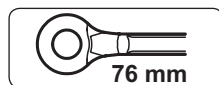

D value 190 kN
Dc value 120 kN
V value 40 kN
Support load 1000 kg

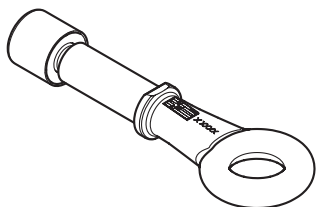

DBE 172

Part no.17-017200
Weight 13,3 kg

Class S
 Type approval no.
 E11*55R-017330

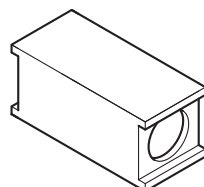

Sleeve

Part no.17-015800
Weight7,2 kg
 ☑ 90 mm for use with all types of screwed drawbar eyes.

Specifications

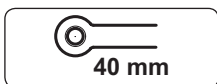

Drawbar eyes for Multi XF and Optimal

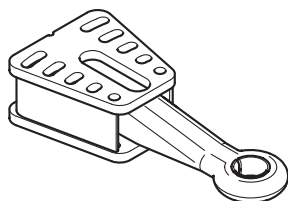

Part no. **25-073083**
 Weight 15,5 kg

D value 130 kN
Dc value -
V value -
Support load -
 Type approval no
 see respective drawbars

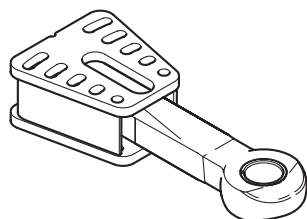
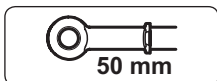

Part no. **25-073183**
 Weight 15,8 kg

D value 188 kN
Dc value -
V value -
Support load -
 Class D50-X
 Type approval no
 see respective drawbars

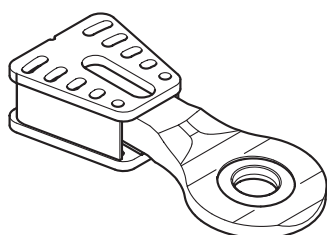
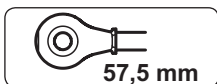

Part no. **25-073283**
 Weight 16,2 kg

D value 188 kN
Dc value -
V value -
Support load -
 Class S
 Type approval no
 see respective drawbars

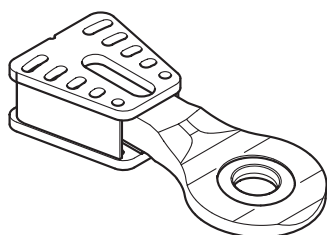
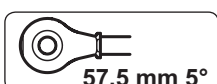

Part no. **25-073383**
 Weight 16,2 kg

D value 188 kN
Trailer weight -
Centre-axle trailer weight -
Support load -
 Class S
 Type approval no
 see respective drawbars

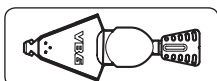

Drawbar wedge for Multi XF and Optimal

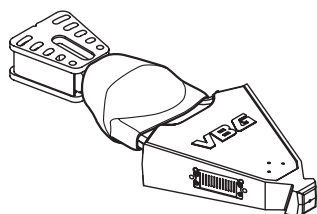

	Weight (kg)	Part no.
Drawbar wedge standard	62	08-108700
Drawbar wedge hydraulic	73	08-109000

D value 188 kN
 Type approval no.
 E24*55R-010106

Angles

Horizontally	± 90°
Vertically	± 20°
Axially	± 25°

Drawbar eyes

Specifications

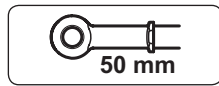

D value 190 kN
Dc value 120 kN
V value 50 kN
Support load 1000 kg
 Class D50-C
 Type approval no.
 E4*55R-010333

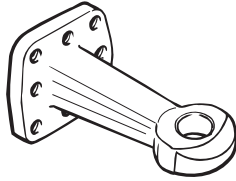

Flanged drawbar eyes

DBE 917

Part no.16-091700
Weight 11,3 kg

	Alt. 1	Alt. 2
D value (kN)	290	290
Dc value (kN)	145	130
V value (kN)	95	75
Support load (kg)	1000	2000
Class S		
Type approval no. E4*55R-01008		

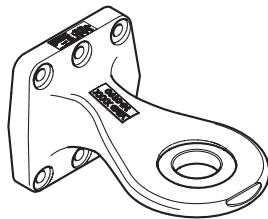
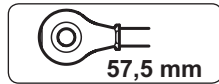

DBE 190

Part no. 15-019000
Weight 19 kg

D value 290 kN
Dc value 135 kN
V value 75 kN
Support load 1000 kg
 Class S
 Type approval no.
 E11*55R-015820

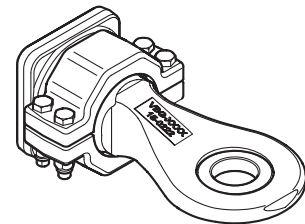

DBE 157

Part no. 15-020500
 (kit with mounting plate)
Weight 20 kg

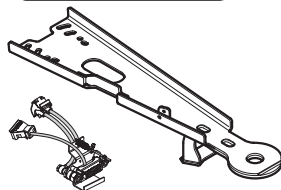
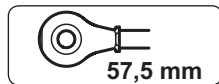

VBG MFC Towing adapter

Max tractor unit weight 34.6 tonne.

Part no.08-106100

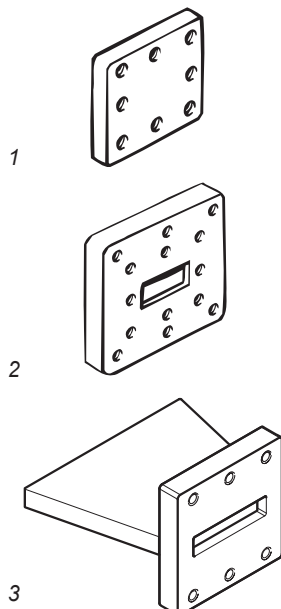

Mounting plates

For drawbar eye	Part no.
16-091700:	16-091000
.....	15-020200
15-019000:	15-020200
.....	15-019800

16-091000 (1).....8 threaded hole
 15-020200 (2)6+8 threaded hole
 15-019800 (3) 6 threaded hole
 with welded wing

Bolt kits

For drawbar eye	Part no.
15-019000:	15-019200
.....	6 bolts M16, Quality 12.9
16-091700:.....	15-020600
.....	8 bolts M16, Quality 12.9

Power plug 14/17 and 14/17 SAL



14 or 17 terminals

Standard or SAL version*

2 cable inlets, Ø 10,5 mm – 15,0 mm

Terminal 1 and 2 9,5 mm 25 A

Single terminal 6,5 mm 15 A

Double terminal 6,5 mm 10 A

The permitted amperage in VBG's power plugs is limited by the earth connection, i.e. a maximum of 25 A.

* SAL-version comparable to IP class 54.

Description	Part no.	Part no. 10-pack
Power plug 14, box.....	28-029000	28-029001
Power plug 14, plug.....	28-036000	28-036001
Power plug 14 SAL, box.....	28-034000	28-034001
Power plug 14 SAL, plug.....	28-036100	28-036101
Power plug 17, box.....	28-029200	28-029201
Power plug 17, plug.....	28-036200	28-036201
Power plug 17 SAL, box.....	28-034500	28-034501
Power plug 17 SAL, plug.....	28-036300	28-036301

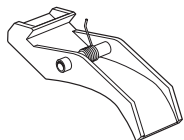

Accessories	Part no.
Lock hook for plug.....	28-027600



Electric heating coil for box or plug.....	28-029900
--	-----------

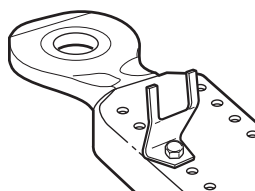

Bracket for recessing.....	18-029700
----------------------------	-----------

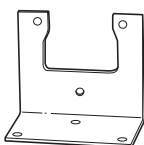

Angle bracket.....	18-029400
--------------------	-----------



Straight bracket for welding.....	18-029600
-----------------------------------	-----------

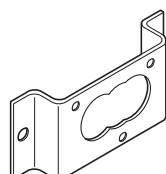

Socket for plug.....	18-030100
----------------------	-----------



Spiral cable 14-pole

Part no. **28-033500**
Weight 2.9 kg
Working length..... 2 250 mm
Max. extension length..... 4 000 mm
Protection class IP67 and IP69K in accordance with DIN 40050.

Technical data

Temperature range -40 °C - +85 °C
Other technical data can be found at www.vbg.eu.



Spiral cable 15-pole

Part no. **28-033600**
Weight 2.9 kg
Working length..... 2 250 mm
Max. extension length..... 4 000 mm
Protection class IP67 and IP69K in accordance with DIN 40050.

Technical data

Temperature range -40 °C - +85 °C
Other technical data can be found at www.vbg.eu.



Spiral cable adapter

Part no. **28-043700**
Weight 2.0 kg
Working length..... 2 250 mm
Max. extension length..... 4 000 mm
Protection class IP67 and IP69K in accordance with DIN 40050.

Technical data

Temperature range..... -40 °C - +85 °C
Other technical data can be found at www.vbg.eu.



ABS connector 5-pole

Part no. **28-037500**
Weight 2.9 kg
Working length..... 2 250 mm
Max. extension length..... 4 000 mm
Protection class IP67 and IP69K in accordance with DIN 40050.

Technical data

Temperature range -40 °C - +85 °C
Other technical data can be found at www.vbg.eu.



Spiral cable 7-pole EBS

Part no. **28-037600**
Weight 2.9 kg
Working length..... 2 250 mm
Max. extension length..... 4 000 mm
Protection class IP67 and IP69K in accordance with DIN 40050.

Technical data

Temperature range -40 °C - +85 °C
Other technical data can be found at www.vbg.eu.



Spiral cable 15-pole

Part no......28-037700
Weight 2,9 kg
Working length 2 250 mm
Max. extension length 4 000 mm
Protection class IP67 and IP69K in accordance with DIN 40050.

Technical data

Temperature range..... -40 °C - +85 °C
Other technical data can be found at www.vbg.eu.



Spiral cable 7-pole

Part no......28-037800
Weight 2,9 kg
Working length 2 250 mm
Max. extension length 4 000 mm
Protection class IP67 and IP69K in accordance with DIN 40050.

Technical data

Temperature range..... -40 °C - +85 °C
Other technical data can be found at www.vbg.eu.



7-pole Spiral cable

Part no......28-037900
Weight 2,9 kg
Working length 2 250 mm
Max. extension length 4 000 mm
Protection class IP67 and IP69K in accordance with DIN 40050.

Technical data

Temperature range..... -40 °C - +85 °C
Other technical data can be found at www.vbg.eu.



Spiral cable adapter 15/7/7-pole

Part no......28-040000
Weight 2,9 kg
Working length 2 250 mm
Max. extension length 4 000 mm
Protection class IP67 and IP69K in accordance with DIN 40050.

Technical data

Temperature range..... -40 °C - +85 °C
Other technical data can be found at www.vbg.eu.



Spiral cable 17-pole

Part no......28-046400
Weight 2,0 kg
Working length 2 250 mm
Max. extension length 4 000 mm
Protection class IP67 and IP69K in accordance with DIN 40050.

Technical data

Temperature range..... -40 °C - +85 °C
Other technical data can be found at www.vbg.eu.



VBG MechOil

Part no. 49-005500

Spray can of 400 ml, supplied in 12-pack.



VBG ElectroOil

Part no. 49-005300

Spray can of 400 ml, supplied in 12-pack.



Keep it safe-kit

Part no. 49-002400

The kit contains:

- 1 st Wear gauge (plastic)
- 1 st Driver's Manual
- 1 st MechOil
- 1 st ElectroOil

Reflectors for trucks

The rear marker plates comply with all the requirements in ECE directive no. 70 and supplement no. 70.01. The aluminium plates have rounded corners: R=15 mm.

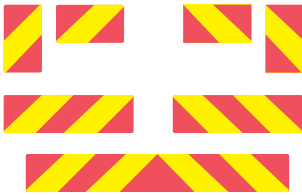

Size	1 set =	Order no.	10-pack
132 x 283.....Self-adhesive.....	4 pcs.....	98-016800.....	98-016801
132 x 283.....Aluminium.....	4 pcs.....	98-026800.....	98-026801
132 x 565.....Self-adhesive.....	2 pcs.....	98-017000.....	98-017001
132 x 565.....Aluminium.....	2 pcs.....	98-027000.....	98-027001
132 x 1130Self-adhesive.....	2-part.....	98-017000.....	98-017001
132 x 1130Aluminium.....	1 pcs.....	98-027100.....	98-027001

Reflectors for trailers

The rear marker plates comply with all the requirements in ECE directive no. 70 and supplement no. 70.01. The aluminium plates have rounded corners: R=15 mm.

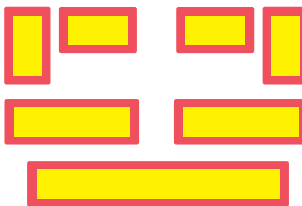

Size	1 set =	Order no.	10-pack
197 x 283.....Self-adhesive.....	4 pcs.....	98-017200.....	98-017201
197 x 283.....Aluminium.....	4 pcs.....	98-027200.....	98-027201
197 x 565.....Self-adhesive.....	2 pcs.....	98-017300.....	98-017301
197 x 565.....Aluminium.....	2 pcs.....	98-027300.....	98-027301
197 x 1130Self-adhesive.....	2-part.....	98-017400.....	98-017401
197 x 1130Aluminium.....	1 pcs.....	98-027400.....	98-027401

Reflectors for Modular System

The signs can be folded together when not running the modular vehicle combination.



Specifications	Quantity	Order no.
Reflex modular vehicle	1 pcs	98-418000
Reflex modular vehicle "SÆRTRANSPORT"	1 pcs	98-029800

Reflectors with text "WIDE LOAD"



Size	Qty	Order no.
1280 x 410 Aluminium 2 mm.....	1 pcs	98-025000



Outline markers

Approved and marked in accordance with ECE directive no. 104.



Self-adhesive reflector strips: 50,8 mm x 50 m.

Outline markers for hard sides **Best. nr**

Red (Rear).....98-011100

Yellow (Side).....98-011200

White (Side).....98-011300

Other types of markers can be quoted on request.



