

# TEBS E

ELECTRONIC BRAKING SYSTEM FOR TRAILERS

VERSIONS E0 TO E5

## SYSTEM DESCRIPTION

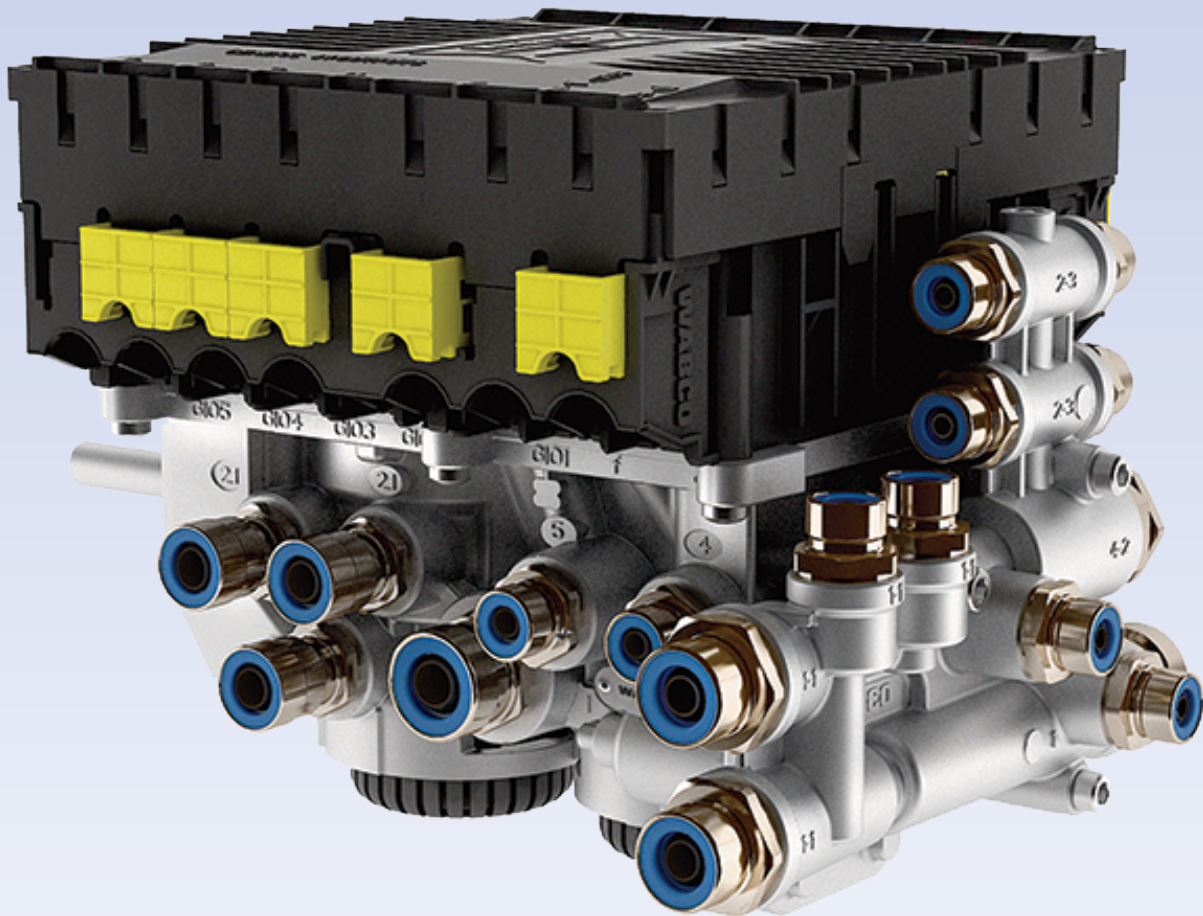

**WABCO**



## Table of contents

<b>1</b>	<b>List of abbreviations</b> .....	<b>6</b>
<b>2</b>	<b>General information</b> .....	<b>7</b>
<b>3</b>	<b>Safety information</b> .....	<b>11</b>
<b>4</b>	<b>Introduction</b> .....	<b>13</b>
4.1	System structure . . . . .	14
4.1.1	<i>Braking system</i> .....	14
4.1.2	<i>Braking system with conventional air suspension</i> .....	15
4.1.3	<i>Electronically controlled air suspension</i> .....	18
4.2	Function overview . . . . .	20
<b>5</b>	<b>Braking system</b> .....	<b>23</b>
5.1	System design . . . . .	23
5.2	Scope of application . . . . .	23
5.3	Expert reports and standards . . . . .	24
5.4	ABS configurations . . . . .	25
5.5	Description of the components of the electro-pneumatic braking system . . . . .	29
5.6	TEBS E Modulator components . . . . .	32
5.7	Supply . . . . .	32
5.7.1	<i>Function test when switching on or coupling</i> .....	33
5.7.2	<i>Power supply from stop light (24N)</i> .....	33
5.7.3	<i>Operation powered by battery in trailer vehicle</i> .....	33
5.7.4	<i>Multi-Voltage</i> .....	33
5.8	System monitoring . . . . .	35
5.8.1	<i>Warnings and system messages</i> .....	35
5.8.2	<i>Pneumatic redundancy</i> .....	37
5.9	Brake functions . . . . .	37
5.9.1	<i>Nominal value detection</i> .....	38
5.9.1.1	<i>External nominal pressure sensor</i> .....	38
5.9.2	<i>Load Sensing Valve (LSV)</i> .....	40
5.9.2.1	<i>Mechanical suspensions</i> .....	43
5.9.3	<i>Pressure control</i> .....	44
5.9.4	<i>Overload protection</i> .....	45
5.9.5	<i>Anti-Lock Braking System (ABS)</i> .....	46
5.9.6	<i>Roll Stability Support (RSS)</i> .....	47
5.9.7	<i>Standstill function</i> .....	49
5.9.8	<i>Emergency braking function</i> .....	49
5.9.9	<i>Test mode</i> .....	49
5.10	ECU-internal functions. . . . .	50
5.10.1	<i>Odometer</i> .....	50
5.10.2	<i>Service signal</i> .....	51
5.10.3	<i>ServiceMind</i> .....	51
5.10.4	<i>Axle load output</i> .....	53
5.10.5	<i>Notebook function</i> .....	55
5.10.6	<i>Service documentation (from TEBS E5)</i> .....	56
5.10.7	<i>Operating data record (ODR)</i> .....	56
<b>6</b>	<b>GIO functions</b> .....	<b>59</b>
6.1	Lifting axle control . . . . .	60
6.2	Tag axle control with maintained residual pressure . . . . .	65
6.3	Integrated electronically controlled air suspension system (ECAS) . . . . .	66

# Table of contents

6.3.1	Nominal level control	73
6.3.2	Driving levels	75
6.3.3	Green warning lamp	77
6.3.4	Temporary deactivation of the automatic level control	78
6.4	Speed switch (ISS 1 and ISS 2) and RtR	79
6.5	Traction help	81
6.6	External axle load sensor	85
6.7	Dynamic wheelbase control	86
6.7.1	Manoeuvring assistance (OptiTurn™)	86
6.7.2	Drawbar load reduction (OptiLoad™)	88
6.7.3	Connecting the components	91
6.8	Forced lowering and deactivation of the lifting axle function	94
6.9	Active RSS signal (from TEBS E2)	97
6.10	Active ABS signal (from TEBS E2)	97
6.11	Brake lining wear indicator (BVA)	98
6.12	Power supply and data communication at GIO5	100
6.13	Speed signal	100
6.14	Steady positive voltage 1 and 2	101
6.15	Road finisher brake	102
6.15.1	Proximity switch	106
6.16	Trailer Extending Control	107
6.17	Actual vehicle length (Trailer Length Indication) (from version TEBS E4)	109
6.18	Tilt warning (Roll Stability Adviser)	111
6.19	Overload detection	113
6.20	SafeStart	114
6.21	Electronic parking brake (from version TEBS E4)	116
6.22	Relaxation function (Bounce Control)	118
6.23	Steering axle lock	119
6.24	Forklift control	120
6.25	Brake release function	122
6.26	Emergency stop light (Emergency Brake Alert)	123
6.27	Immobilizer	125
6.28	Freely configurable functions	130
<b>7</b>	<b>External systems</b>	<b>132</b>
7.1	Electronic extension module	132
7.1.1	TailGUARD™ functions	134
7.1.2	Connecting ISO 12098	140
7.1.3	Battery supply and battery charging	140
7.2	Trailer Remote Control	142
7.3	External ECAS	143
7.4	Trailer Central Electronic	144
7.5	Tire pressure monitoring (OptiTire™)	145
7.6	Telematics (TX-TRAILERGUARD™)	148
<b>8</b>	<b>Installation notes for vehicle construction and retrofitting</b>	<b>149</b>
8.1	Safety information	149
8.2	Data on the TEBS E Modulator	150
8.3	Connections	151
8.4	Installation in vehicle	153
8.4.1	RSS installation regulation	154
8.5	Cable installation / cable fastenings	156
8.6	Installing the height sensor	158



# Table of contents

8.7	Installing the immobilizer components	160
8.8	Installing the Trailer Remote Control	161
8.9	Installing the TailGUARD™ components	161
8.10	Installing eTASC	172
<b>9</b>	<b>Start-up</b>	<b>173</b>
9.1	Brake calculation	173
9.2	Parameter setting in TEBS E diagnostic software	173
9.3	Functional test	175
9.4	Start-up of the LIN ultrasonic sensors	175
9.5	Calibrate the height sensors	177
9.5.1	Calibration for vehicles with mechanical suspension	179
9.6	Documentation	180
<b>10</b>	<b>Operation</b>	<b>181</b>
10.1	Warning messages	181
10.2	Operation with the Trailer Remote Control	181
10.3	Operating the ECAS level control	189
10.3.1	Operating the ECAS level control (without eTASC)	189
10.3.2	Operating ECAS level control with eTASC	191
10.4	Operating the traction help	191
10.5	Operating OptiLoad™ / OptiTurn™	192
10.6	Operating the lifting axles	192
10.7	Operating the Immobilizer	193
<b>11</b>	<b>Workshop notes</b>	<b>194</b>
11.1	Maintenance	194
11.2	System training and PIN	194
11.3	Diagnosis hardware	195
11.4	Tests / Simulations	196
11.5	Replacement and repair	197
11.6	Truck/trailer harmonisation	200
11.7	Disposal / recycling	201
<b>12</b>	<b>Appendix</b>	<b>202</b>
12.1	Pneumatic connections for TEBS E	202
12.2	Pin assignment	204
12.2.1	TEBS E Modulators	204
12.2.2	Electronic extension module	206
12.3	Cable overview	209
12.3.1	Cable overview "Modulator"	210
12.3.2	Cable overview "Electronic Extension Module"	216
12.4	GIO schematic diagrams	218
12.5	Braking diagram	220



## 1 List of abbreviations

ABBREVIATION	MEANING
<b>ABS</b>	Anti-Lock Braking System
<b>ADR</b>	(French: Accord européen relatif au transport international des marchandises Dangereuses par Route); European agreement on the transportation of dangerous goods by road
<b>LSV</b>	Load Sensing Valve
<b>BAT</b>	Battery
<b>BO</b>	(German: Betriebs-Ordnung); Factory regulations; BO force circuit = legally defined turning circuit
<b>BVA</b>	(German: Bremsbelagverschleißanzeige); brake lining wear indicator
<b>CAN</b>	Controller Area Network; asynchronous serial bus system for networking control units in vehicles
<b>ECAS</b>	Electronically Controlled Air Suspension
<b>ECE</b>	Economic Commission for Europe
<b>ESD</b>	Electrostatic Discharge
<b>eTASC</b>	Electronic Trailer Air Suspension Control (rotary slide valve with RTR function) and ECAS function
<b>GGVS</b>	(German: Gefahrgut-Verordnung Straße); act governing the road haulage of hazardous goods
<b>GIO</b>	Generic Input/Output
<b>IR</b>	(German: Individual-Regelung); individual control of sensed wheels on one side
<b>ISO</b>	International Organization for Standardization
<b>ISS</b>	Integrated Speed Switch
<b>LACV-IC</b>	Lifting Axle Control Valve, Impulse-Controlled
<b>LIN</b>	Local Interconnect Network; specification for a serial communication system, also called LIN bus; sensor interface
<b>MAR</b>	(German: Modifizierte Achs-Regelung); modified axle control; control of two sensed wheels on one axle
<b>MSR</b>	(German: Modifizierte Seiten-Regelung); modified side control; control of two sensed wheels on one vehicle side
<b>ODR</b>	Operating Data Recorder
<b>PEM</b>	Pneumatic Extension Module
<b>PLC</b>	Power Line Communication; data communication via cable for power supply
<b>PREV</b>	Park Release Emergency Valve
<b>PUK</b>	Personal Unblocking Key
<b>PWM</b>	Pulse Width Modulation; modulation type where a technical quantity (e.g. electric current) modulates between two values.
<b>RSD</b>	Rotary Slide Detection
<b>RSS</b>	Roll Stability Support
<b>RtR</b>	Return to Ride (air suspension)
<b>SHV</b>	Select High Valve; valve for governing higher pressure
<b>SLV</b>	Select Low Valve; valve for governing lower pressure
<b>StVZO</b>	(German: Straßenverkehrs-Zulassungs-Ordnung); German motor vehicle construction and use regulations (valid in Germany)
<b>TASC</b>	Trailer Air Suspension Control; rotary slide valve with RtR function
<b>TEBS</b>	Electronic Braking System for Trailers
<b>TLI</b>	Trailer Length Indication; actual vehicle length
<b>TT</b>	Timer Ticks; internal measurement unit in height sensors
<b>USB</b>	Universal Serial Bus

## 2 General information

### Purpose of the document

This document is intended for use by trailer vehicle manufacturers and workshops.



### Copyright and trademark notice

The content, particularly technical information, descriptions and figures, corresponds to the state current at the time of printing and is subject to change without notice.

This document, including all its parts, in particular texts and figures, is protected by copyright. Use outside the statutory or contractual limits require authorisation by the copyright owner. All rights reserved.

Any brand names, even if not indicated as such, are subject to the rules of the trademark and labelling rights.

### Symbols used

 <b>WARNING</b>	<b>Specifies a potentially hazardous situation</b> Not observing the safety instruction can result in severe injuries or death. – <i>Follow the instructions in this warning note to avoid injury or death.</i>
 <b>CAUTION</b>	<b>Specifies a potentially hazardous situation</b> Specifies a possible hazardous situation Not observing the safety instruction can result in minor or moderately severe injuries. – <i>Follow the instructions in this warning note to avoid any injuries.</i>
<b>CAUTION</b>	<b>Specifies possible material damage</b> Not observing the safety instruction can lead to material damage. – <i>Follow the instructions in this warning note to avoid any material damage.</i>

 Important information, instructions and/or tips that you must always observe without fail.



Reference to information on the internet

- Action step
  - ⇒ Consequence of an action
- List

## General information

TEBS E VERSION	SYSTEM COMPRISES:	DATE
TEBS E	TEBS E from Version 0	July 2007
TEBS E1	TEBS E from Version 1	September 2008
TEBS E1.5	TEBS E from Version 1.5	December 2009
TEBS E2	TEBS E from Version 2 Electronic extension module / Trailer Remote Control from Version 0	November 2010
TEBS E2.5	TEBS E from Version 2.5 Electronic extension module / Trailer Remote Control from Version 1	January 2012
TEBS E4	TEBS E from Version 4 Electronic extension module / Trailer Remote Control from Version 2	January 2014
TEBS E5	TEBS E from Version 5 Electronic extension module / Trailer Remote Control from Version 2	October 2015

## Technical documents



- Open the WABCO INFORM online product catalogue:  
<http://inform.wabco-auto.com>
- Search for documents by entering the document number.

The WABCO online product catalogue INFORM provides you with convenient access to the complete technical documentation.

All documents are available in PDF format. Please contact your WABCO partner for printed versions.

Please note that the publications are not always available in all language versions.

DOCUMENT TITLE	DOCUMENT NUMBER
General Repair and Test Information	815 XX0 109 3
CAN Router / CAN Repeater – System Description	815 XX0 176 3
TailGUARD™ System Description	815 XX0 211 3
Diagnostic Product Overview	815 XX0 037 3
ECAS for Trailer Vehicles – System Description	815 XX0 025 3
Compressed Air Brake Equipment for Trailer Vehicles	815 XX0 034 3
OptiTire™ – System Description	815 XX0 229 3
ODR Tracker – Operating Manual	815 XX0 149 3

## General information

DOCUMENT TITLE	DOCUMENT NUMBER
SmartBoard – Operating Instructions	815 XX0 138 3
SmartBoard – System Description	815 XX0 136 3
TASC Trailer Air Suspension Control – Function and Assembly	815 XX0 186 3
Trailer Central Electronic I / II Trailer Central Electronic – System Description	815 XX0 030 3
Trailer EBS E Connections – Poster	815 XX0 144 3
Trailer EBS E – Replacing the Modulator	815 980 183 3
Trailer EBS E System Overview – Poster	815 XX0 143 3
TX-TRAILERGUARD™	<a href="http://www.transics.com">www.transics.com</a>
Trailer Remote Control – Operating Manual	815 990 193 3
Trailer Remote Control – Installation and Connection Instructions	815 XX0 195 3
Couplings Catalogue	815 XX0 080 3

\*Language code XX: 01 = English, 02 = German, 03 = French, 04 = Spanish, 05 = Italian, 06 = Dutch, 07 = Swedish, 08 = Russian, 09 = Polish, 10 = Croatian, 11 = Romanian, 12 = Hungarian, 13 = Portuguese (Portugal), 14 = Turkish, 15 = Czech, 16 = Chinese, 17 = Korean, 18 = Japanese, 19 = Hebrew, 20 = Greek, 21 = Arabic, 24 = Danish, 25 = Lithuanian, 26 = Norwegian, 27 = Slovenian, 28 = Finnish, 29 = Estonian, 30 = Latvian, 31 = Bulgarian, 32 = Slovakian, 34 = Portuguese (Brazil), 35 = Macedonian, 36 = Albanian, 97 = German/English 98 = = multilingual, 99 = non-verbal

### Structure of the WABCO product number

WABCO product numbers consist of 10 digits.

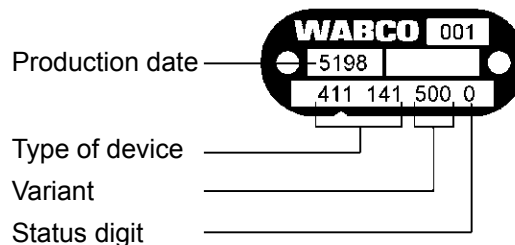

0 = New device (complete device)  
 1 = New device (subassembly)  
 2 = Repair kit or subassembly  
 4 = Component part  
 7 = Replacement device  
 R = Reman

### Choose genuine WABCO parts

Genuine WABCO parts are made of high quality materials and are rigorously tested before they leave our factories. You also have the assurance that the quality of every WABCO product is supported by a powerful customer service network.

As a leading supplier to the industry, WABCO collaborates with the world's leading original equipment manufacturers, and disposes of the experience and capacitive capability required to also satisfy the most stringent production standards. The quality of every genuine WABCO part is supported by:

- Tooling made for serial production
- Regular sub-supplier audits
- Exhaustive end-of-line tests

## General information

- Quality standards < 50 PPM

**Installing replica parts can cost lives – genuine WABCO parts protect your business.**

### WABCO additional services

The package you will get with a genuine WABCO part:

- 24-month product warranty
- Overnight delivery
- Technical support from WABCO
- Professional training solutions from the WABCO Academy
- Access to diagnostics tools and support from the WABCO Service Partner network
- Straightforward claims handling
- Plus, of course, the confidence that the Original Equipment Manufacturers' rigorous quality standards are met

### WABCO Service Partner

WABCO Service Partners – the network you can rely on. You can access 2000 high quality workshops with more than 6000 specialist mechanics, all trained to WABCO's exacting standards and equipped with our most up-to-the-minute systems diagnostic and support technology.

### Your direct contact to WABCO

In addition to our online services, trained members of staff are there to help you at our WABCO Service Partners to directly answer any technical or business-related questions you may have.

Contact us if you need assistance:

- Find the right product
- Diagnosis support
- Training
- System support
- Order management



You can find your WABCO partner here:

<http://www.wabco-auto.com/en/how-to-find-us/contact/>

---

## 3 Safety information

### Observe all required provisions and instructions:

- Read this publication carefully.  
Adhere to all instructions, information and safety information to prevent injury to persons and damage to property.  
WABCO will only guarantee the safety, reliability and performance of their products and systems if all the information in this publication is adhered to.
- Always abide by the vehicle manufacturer's specifications and instructions.
- Observe all accident regulations of the respective company as well as regional and national regulations.

### Make provisions for a safe work environment:

- Only trained and qualified technicians are to perform work on the vehicle.
- Use personal protective equipment if required (protective goggles, respiratory protection, ear protectors, etc.).
- Pedal actuations can lead to severe injuries if persons are in the vicinity of the vehicle. Make sure that pedals cannot be actuated as follows:
  - Switch the transmission to "neutral" and apply the park brake.
  - Secure the vehicle against rolling by using chocks.
  - Fasten a visible note to the steering wheel indicating that work is being performed on the vehicle and that the pedals are not to be actuated.

### Avoid electrostatic charge and uncontrolled discharging (ESD):

Note during construction and building the vehicle:

- Prevent potential differences between components (e.g. axles) and the vehicle frame (chassis).  
Make sure that the resistance between metallic parts of the components and the vehicle frame is less than 10 ohms.  
Establish an electrically conductive connection between moving or insulated vehicle parts, such as axles, and the frame.
- Prevent potential differences between the towing vehicle and the trailer.  
Make sure that an electrically conductive connection is made between metal parts in the towing vehicle and the coupled trailer via the coupling (king pin, fifth wheel, claws with pins), even without a cable being connected.
- Use electrically conductive bolted connections when fastening the ECUs to the vehicle frame.
- Run the cable in metallic casing if at all possible (e.g. inside the U-beam) or behind metallic and grounded protective plating, to minimise the influence of electro-magnetic fields.
- Avoid the use of plastic materials if they can cause electrostatic charging.
- For electrostatic painting, connect the ground line of the ISO 7638 plug connection (pin 4) to the paint ground (vehicle chassis).



## Take note while carrying out repair or welding work on the vehicle:

- Disconnect the battery (if installed in the vehicle).
- Disconnect cable connections to devices and components and protect connectors and ports against contamination.
- Always connect the grounding electrode directly with the metal next to the welding point when welding to prevent magnetic fields and current flow via the cable or components.
- Make sure that current is well conducted by removing paint or rust.
- Prevent heat influences on devices and cabling when welding.

## Special note when using prefabricated TEBS support modules for installations in the vehicle:

Prefabricated TEBS support modules are today frequently installed in trailer vehicles as the result of optimised production processes at the trailer vehicle manufacturers. The TEBS E Modulators as well as many different valves are fastened to these cross-member supports. These support modules are often painted, so when they are installed in the vehicle frames, the electrical conductivity between the frame and support module has to be restored.

Ensuring the electrical conductivity between the support module and the vehicle frame:

- Fasten the support module to the vehicle frame with electrically conductive screw joints using self-tapping screws with a conducting surface.
- The resistance between the support module and the frame must be  $< 10$  ohms.

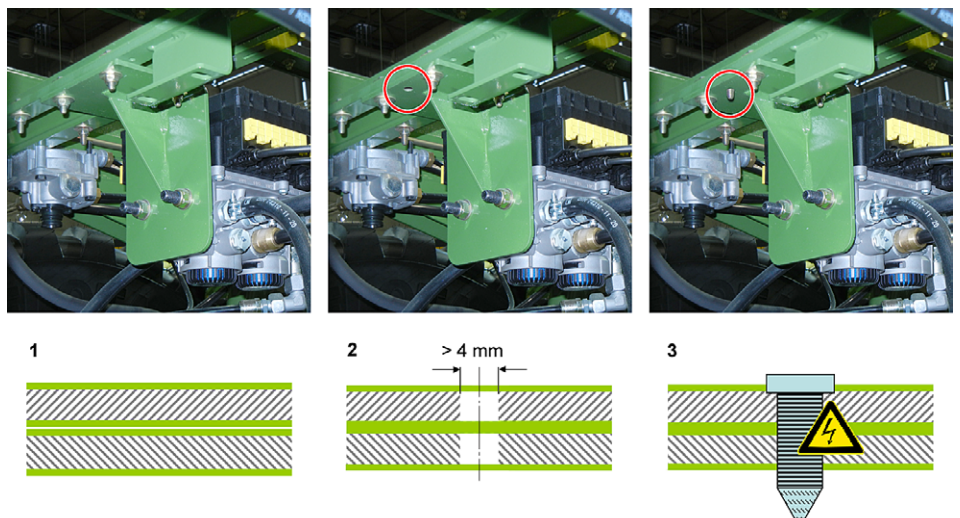

## 4 Introduction

Since the Trailer EBS E is a very complex system, this system description is likewise very extensive. Here are some notes on the structure of the document:

### Braking system

This chapter provides a description of the functions that are required to meet legal guidelines, such as the ABS, RSS and other braking control functions.

### GIO functions

Besides controlling the wheel brakes, the Trailer EBS E Premium variant has a number of functions that can be realised for specific vehicles. Alongside the solutions "prepared" by WABCO, such as the control of air suspension systems or the dynamic wheelbase control, methods for implementing customisable third-party controllers from the vehicle manufacturer are also explained in this chapter.

### External systems

In this chapter, you will find information about the following external systems that can be connected to the Trailer EBS E Modulator: electronic extension module (including descriptions of the available extra functions), Trailer Remote Control, tire pressure monitoring system (OptiTire™), external ECAS, Trailer Central Electronic system and telematics (TX-TRAILERGUARD™).

### Installation notes for vehicle construction and retrofitting

This chapter contains descriptions on how individual components and cables are installed and mounted.

### Start-up

In addition to start-up and calibration, this chapter also explains how to configure the Parameter setting using the TEBS E diagnostic software.

### Operation

This chapter describes in more detail how to operate certain function by means of remote control units (SmartBoard, Trailer Remote Control, etc.).

### Workshop notes

This chapter mainly provides notes on maintenance, system diagnosis, system training, troubleshooting, truck-trailer harmonisation and on repairing/replacing components.

### Appendix

The appendix contains diagrams and overviews.

## 4.1 System structure

This chapter provides you with a general overview of the functions and structures of the basic systems.

### 4.1.1 Braking system

#### Standard semitrailers with ABS configuration 2S/2M

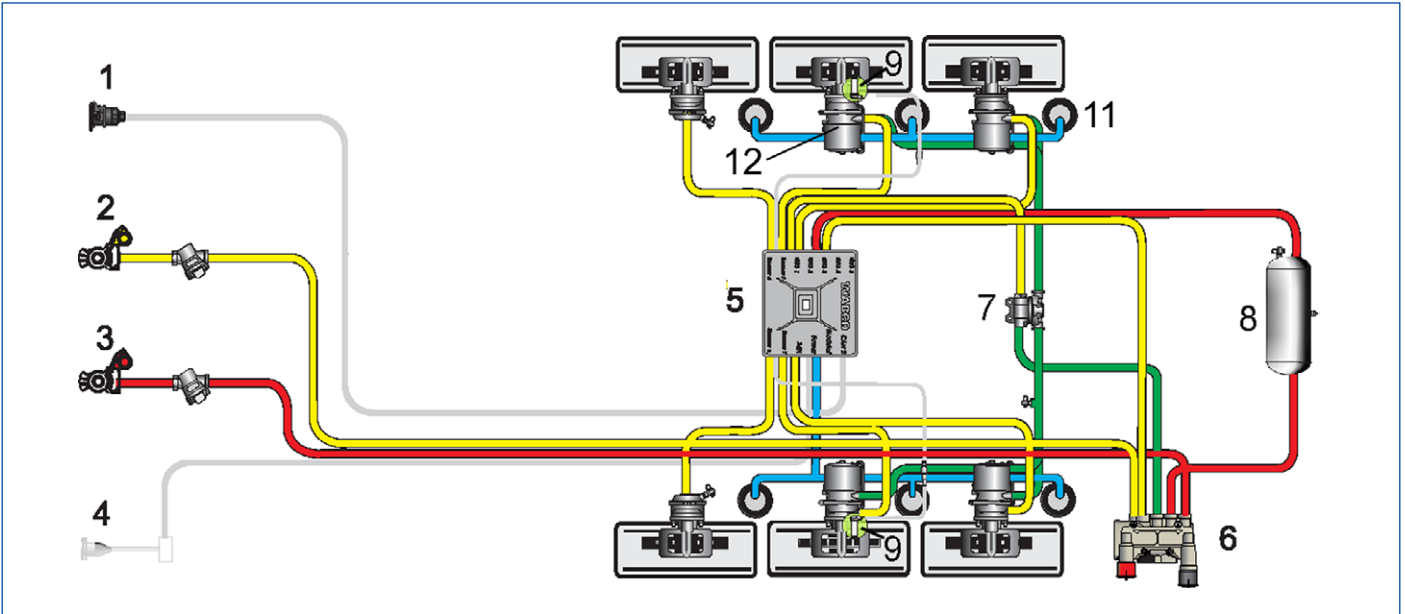

#### Standard drawbar trailers with ABS configuration 4S/3M

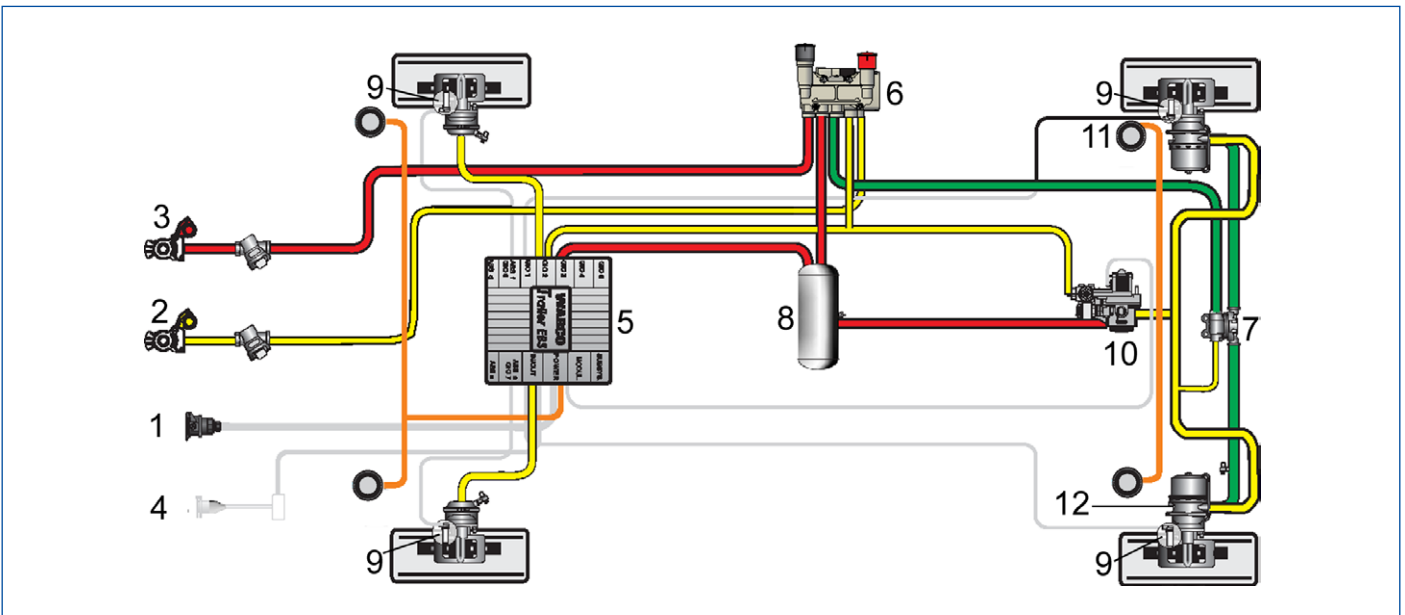

ITEM	DESIGNATION
1	Power supply via ISO 7638
2	Control line
3	Supply line

ITEM	DESIGNATION
4	Stop light supply 24N via ISO 1185 (optional)
5	TEBS E Modulator (with integrated pressure sensors and integrated backup valve)
6	Park-release emergency valve (PREV)
7	Overload protection valve
8	Service brake system reservoir
9	ABS speed sensor
10	EBS relay valve for controlling the 2nd axle (3rd modulator)
11	Support bellow
12	Tristop™ cylinder

The lines represent the cabling and piping in the components.

## 4.1.2 Braking system with conventional air suspension

With the introduction of the new Trailer EBS E braking system, the piping and cabling for the trailer braking and air suspension system have been simplified considerably.

### Trailer braking system with conventional air suspension

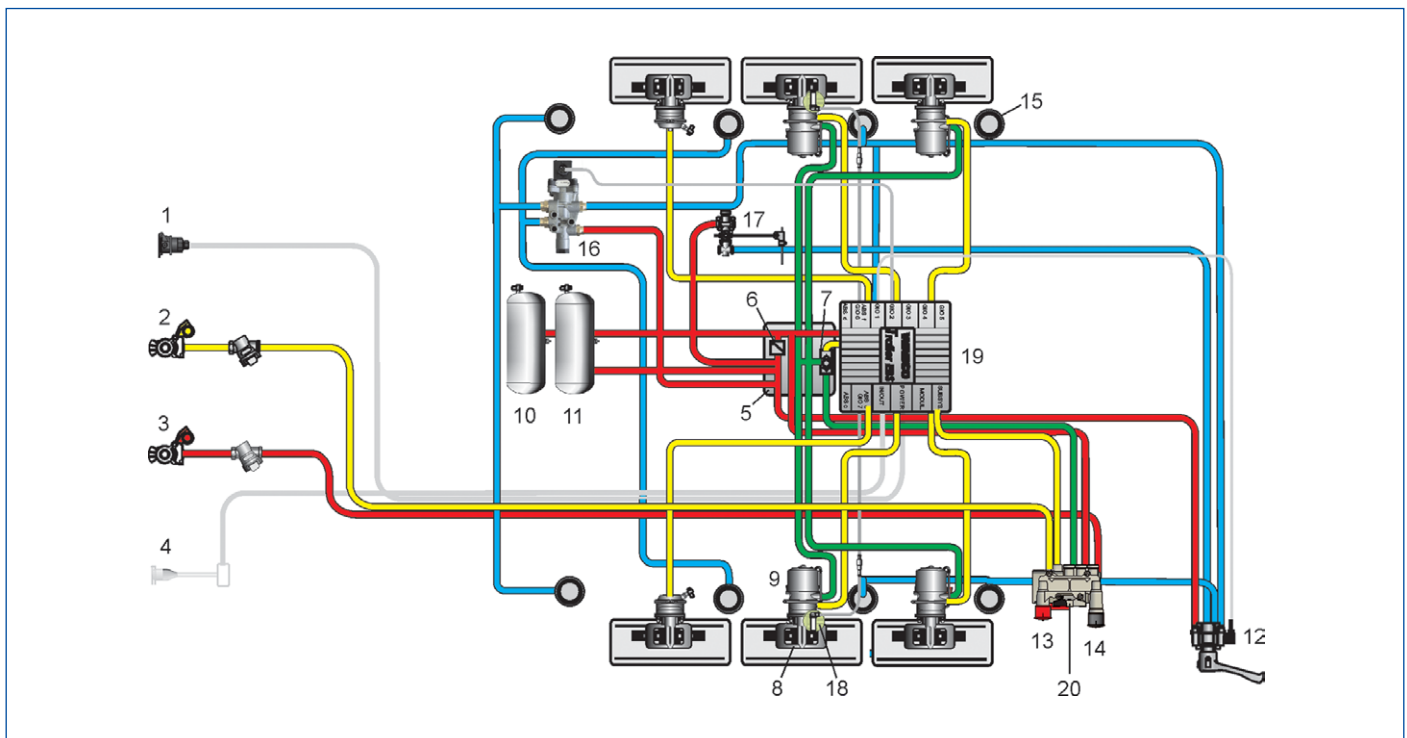

ITEM	DESIGNATION
1	Power supply via ISO 7638
2	Control line
3	Supply line
4	Stop light supply 24N via ISO 1185 (optional)
5	Pneumatic Extension Module (PEM)
6	Charging valve (integrated in the PEM)

ITEM	DESIGNATION
7	Overload protection valve (integrated in the PEM)
8	Service brake part of the Tristop™ cylinders
9	Tristop™ cylinder
10	Service brake system reservoir
11	Reservoir for the air suspension
12	Lifting/lowering valve (e.g. TASC)
13	Red button for actuating the parking brake system (on PREV)
14	Black button for releasing the automatic brake (on PREV)
15	Support bellow
16	Lifting axle valve
17	Levelling valve
18	ABS speed sensor
19	TEBS E Modulator
20	Park-release emergency valve (PREV)

The lines represent the cabling and piping in the components.

## Braking system

The trailer vehicle is connected to the towing vehicle by two coupling heads for the supply pressure (3) and control pressure (2). The park release emergency valve (PREV, 20) is used to conduct the control pressure to the TEBS E Modulator (19). The PREV is equipped with a red actuating button (13) for actuating the parking brake, as well as a further black actuating button (14) for releasing the brake which is automatically actuated when the trailer vehicle is unhitched. The compressed air from the reservoir flows to the Pneumatic Extension Module (PEM, 5) via a check valve integrated in the PREV.

The PEM includes the following functions:

- an charging valve for safeguarding the pressure in the air braking system with respect to the air suspension,
- an overload protection valve to prevent the wheel brakes from overloading when the service and parking brakes are applied simultaneously,
- a pressure distribution for the "air suspension" pressure and "service brake" pressure.

The TEBS E Modulator controls the service brake components (8) of the Tristop™ cylinders (9). At least two ABS rotational speed sensors (18) are connected for sensing the wheel speeds. A pressure test connection is also provided on the PEM for measuring the actual braking pressure. The PEM charges the service brake system reservoir (10) with the supply pressure from the PREV.

The same line is used to supply the TEBS E Modulator with supply pressure from the reservoir. The reservoir for the air suspension system (11) is filled via the charging valve integrated in the PEM. The charging valve has the task of ensuring that primary pressure is maintained in the "Brake" reservoir, and consequently that the trailer vehicle is capable of braking in the event of a pressure drop in the air suspension system. To prevent the wheel brakes from being overstrained due to the additional brake force (the diaphragm and spring actuator parts of the Tristop™ cylinder are actuated simultaneously),

an overload protection valve (7) is integrated in the PEM. The pressure is distributed to the Tristop™ cylinders (9) by the PEM.

The parking brake is applied by pressing the red button on the PREV (13). This vents the parking brake component of the Tristop™ cylinder so that the integrated spring can actuate the wheel brake. If the service brake is also used while the parking brake is applied, the braking pressure flows into the parking brake component of the Tristop™ cylinders via the overload protection valve, thereby relieving the force in the parking brake component in proportion to the braking force built up in the service brake component, and so ensuring that there is no addition of force.

## Conventional air suspension system

The conventional air suspension system comprises a levelling valve (17) and a lifting/lowering valve, e.g. TASC (12) ▶ chapter "6.4 Speed switch (ISS 1 and ISS 2) and RtR", page 79. Both valves are supplied with supply pressure by the PEM. The levelling valve adjusts to the normal level (ride height) of the trailer vehicle by adjusting the amount of air in the support bellows (15). The lifting/lowering valve can be used to change the level of the trailer vehicle manually, for example for loading or unloading. In addition, a lifting axle valve (16), which is modulated by the TEBS E Modulator relative to load, may also be installed. The lifting axle valve is likewise supplied with supply pressure by the PEM.

## 4.1.3 Electronically controlled air suspension

An electronically controlled air suspension system (ECAS) is part of the TEBS E Modulator (Premium) variant.

### 1-point control mechanism with one height sensor and one lifting axle (for semitrailers)

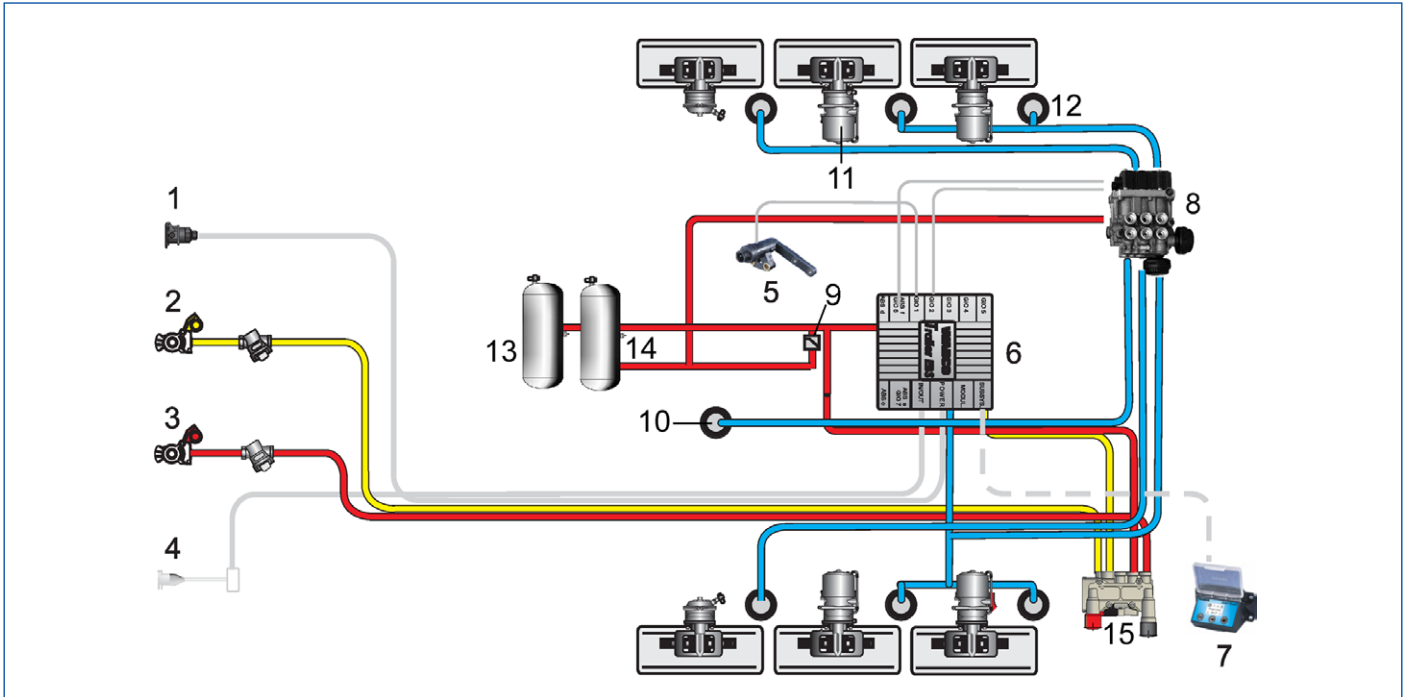

ITEM	DESIGNATION
1	Power supply via ISO 7638
2	Control line
3	Supply line
4	Stop light supply 24N via ISO 1185 (optional)
5	Height sensor
6	TEBS E Modulator (Premium) with integrated control unit and integrated bellows pressure sensor for lifting axle control
7	External remote control unit, e.g. SmartBoard, Trailer Remote Control, ECAS remote control unit or ECAS control box
8	ECAS solenoid valve (with lifting axle control)
9	Charging valve
10	Lifting bellows
11	Tristop™ cylinder
12	Support bellow
13	Service brake system reservoir
14	Reservoir for the air suspension
15	Park-release emergency valve (PREV)

The lines represent the cabling and piping in the components.

The brake lines are not shown in this diagram.



## 2-point control mechanism with two height sensors (from version TEBS E2)

TEBS E4

The 2-point control mechanism can also be implemented without an electronic extension module. This applies for the Premium or Multi-Voltage variant.

ECAS solenoid valves or two eTASC can be used to control the air suspension.

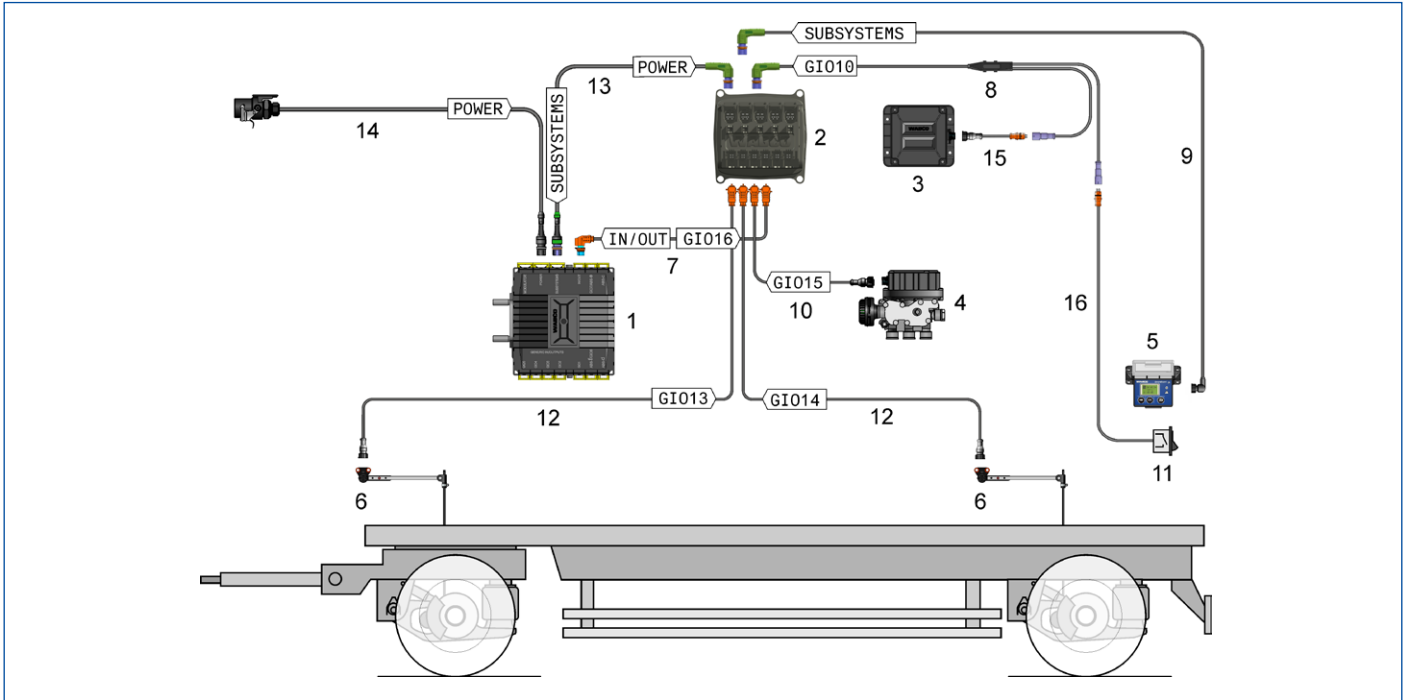

ITEM	DESIGNATION	PART NUMBER
1	TEBS E Modulator (Premium)	480 102 06X 0
2	Electronic extension module	446 122 070 0
3	Battery box	446 156 090 0
4	ECAS solenoid valve (+ pulse-controlled lifting axle)	472 880 001 0 Alternative: 472 905 111 0
5	External remote control unit, e.g. SmartBoard	446 192 11X 0
6	Height sensors	441 050 100 0
7	Cable for TEBS E battery power supply (not required from TEBS E4)	449 808 XXX 0
8	Distribution cable for battery and/or light	449 803 XXX 0
9	Cable for SmartBoard	449 906 XXX 0
10	Cable for ECAS 2-point control mechanism	449 439 XXX 0
11	Switch (for activating/deactivating the battery charge)	Not part of WABCO's scope of supply
12	Cable for height sensor	449 811 XXX 0
13	Power supply cable for Electronic Extension Module	449 303 020 0
14	Power supply cable	449 273 XXX 0
15	TEBS E battery cable	449 807 XXX 0
16	Cable for switch	449 714 XXX 0

The lines represent the cabling and piping in the components.

## 4.2 Function overview

FUNCTIONS	TEBS E MODULATOR		
	STANDARD	PREMIUM	MULTI-VOLTAGE
	FROM VERSION:	FROM VERSION:	FROM VERSION:
<b>Basic functions</b>			
2S/2M	TEBS E0	TEBS E0	TEBS E1.5
4S/2M	–	TEBS E0	TEBS E1.5
4S/2M+1M	–	TEBS E0	TEBS E2
4S/3M	–	TEBS E0	TEBS E2.5
Roll Stability Support (RSS)	TEBS E0	TEBS E0	TEBS E1.5
RSS communication on road trains	TEBS E4	TEBS E4	TEBS E4
CAN 5V connection for subsystems (OptiTire™, TX-TRAILERGUARD™ telematics, SmartBoard)	TEBS E0	TEBS E0	TEBS E1.5
CAN 5V and power supply to GIO5 (TX-TRAILERGUARD™ telematics)	–	TEBS E0	TEBS E1.5
RSS active signal	TEBS E0	TEBS E0	TEBS E2
ABS active signal	TEBS E0	TEBS E0	TEBS E2
Operation Data Recorder (ODR)	TEBS E0	TEBS E0	TEBS E1.5
<b>Speed-dependent functions</b>			
Speed signal	TEBS E0	TEBS E0	TEBS E2
Speed signal 1 / RtR	TEBS E0	TEBS E0	TEBS E2
Speed switch 2	TEBS E1	TEBS E1	TEBS E2
<b>Lifting axle control</b>			
Lifting axle (with lifting axle or ECAS valve)	Lifting axle valve only	TEBS E0	TEBS E2
2 separate lifting axles (with lifting axle or ECAS valve)	Lifting axle valve only	TEBS E0	TEBS E2
Lifting axle control with LACV-IC	–	TEBS E2.5	–
Traction help	TEBS E0	TEBS E0	TEBS E2
Seasonal traction help	<b>TEBS E5</b>	<b>TEBS E5</b>	<b>TEBS E5</b>
Start traction help with reverse gear	TEBS E4	TEBS E4	TEBS E4
Forced lowering	TEBS E0	TEBS E0	TEBS E2
Individual forced lowering of lifting axles	TEBS E4	TEBS E4	TEBS E4
OptiTurn™ (manoeuvring assistance)	–	TEBS E0	TEBS E2
Start OptiTurn™ by reversing	–	TEBS E4	TEBS E4
OptiLoad™ (drawbar load reduction)	–	TEBS E0	TEBS E2
Traction help "off-road"	TEBS E1	TEBS E1	TEBS E2
Forklift control	–	TEBS E2	TEBS E2
Forklift control on 2 lifting axles (change of the main axle)	–	TEBS E4	TEBS E4

FUNCTIONS	TEBS E MODULATOR		
	STANDARD	PREMIUM	MULTI-VOLTAGE
	FROM VERSION:	FROM VERSION:	FROM VERSION:
<b>Internal ECAS functions</b>			
Electronic level control (ECAS 1-point control)	–	TEBS E0	TEBS E2
Electronic level control, ECAS 2-point control mechanism with electronic extension module	–	TEBS E2	TEBS E2
Electronic level control, ECAS 2-point control mechanism without electronic extension module	–	TEBS E4	TEBS E4
Unloading level	–	TEBS E0	TEBS E2
Normal level II	–	TEBS E1	TEBS E2
Tag axle control with maintained residual pressure	–	TEBS E2	TEBS E2
Green warning lamp	–	TEBS E2	TEBS E2
Deactivation of the automatic level control	–	TEBS E2	TEBS E2
eTASC support	–	TEBS E3	TEBS E3
Level control after ignition off	–	<b>TEBS E5</b>	<b>TEBS E5</b>
<b>Brake functions</b>			
Connection "Road finisher brake"	TEBS E0	TEBS E0	TEBS E2
Proximity switch for road finisher brake	–	TEBS E1	TEBS E2
Relaxation function	TEBS E1	TEBS E1	TEBS E2
Brake release function (Bounce Control)	TEBS E1	TEBS E1	TEBS E2
Brake release function (advanced)	–	TEBS E2.5	TEBS E2.5
Trailer Extending Control	–	TEBS E2	TEBS E2
<b>Safety functions</b>			
Brake lining wear indicator (BVA)	TEBS E0	TEBS E0	TEBS E2
Roll Stability Adviser (Trailer Remote Control)	TEBS E1	TEBS E1	TEBS E2
Immobilizer	–	TEBS E1.5	–
Emergency stop light	–	TEBS E2	TEBS E2
SafeStart	–	TEBS E2.5	TEBS E2.5
Electronic parking brake	–	TEBS E4	TEBS E4
TiltAlert	TEBS E0	TEBS E0	TEBS E2
TiltAlert only with raised tipping body	TEBS E4	TEBS E4	TEBS E4
Overload message via indicator lamp	–	TEBS E4	TEBS E4
<b>Other functions</b>			
Freely configurable digital function with output	TEBS E0	TEBS E0	TEBS E2
Freely configurable analogue function with output	TEBS E0	TEBS E0	TEBS E2
Steady positive voltage 1 and 2	TEBS E0	TEBS E0	TEBS E2
Steering axle lock	TEBS E1	TEBS E1	TEBS E2
ServiceMind	TEBS E2	TEBS E2	TEBS E2
Notebook function	TEBS E2	TEBS E2	TEBS E2
Overload message via indicator lamp	–	TEBS E4	TEBS E4

FUNCTIONS	TEBS E MODULATOR		
	STANDARD	PREMIUM	MULTI-VOLTAGE
	FROM VERSION:	FROM VERSION:	FROM VERSION:
Trailer length indicator	–	TEBS E4	TEBS E4
Shared warning signal for multiple functions	TEBS E4	TEBS E4	TEBS E4
Service documents via URL	<b>TEBS E5</b>	<b>TEBS E5</b>	<b>TEBS E5</b>
<b>External sensors</b>			
External axle load sensor	TEBS E0	TEBS E0	TEBS E1.5
Second external axle load sensor c-d	TEBS E2	TEBS E2	TEBS E2
External nominal pressure sensor	TEBS E0	TEBS E0	TEBS E1.5
Height sensor, mechanical suspension	–	TEBS E0	TEBS E1.5
<b>External systems</b>			
Trailer Central Electronic support	TEBS E0	TEBS E0	TEBS E2
External ECAS support	*)	*)	TEBS E2
SmartBoard support	TEBS E0	TEBS E0	TEBS E2
OptiTire™ support	TEBS E0	TEBS E0	TEBS E1.5
Electronic extension module support	–	TEBS E2	TEBS E2
TailGUARD™ (all configurations) with electronic extension module	<b>TEBS E5</b>	TEBS E2	TEBS E2
Battery supply / charging	–	TEBS E2	TEBS E2
Additional GIO connections with electronic extension module	–	TEBS E2	TEBS E2
Connection to ISO 12098 from electronic extension module	–	TEBS E2	TEBS E2
<b>CAN router / CAN repeater</b>			
CAN communication	TEBS E0	TEBS E0	TEBS E1.5
Nominal value pressure sensor on CAN router / CAN repeater	TEBS E2	TEBS E2	TEBS E2

! \*) Only up to TEBS E3, from TEBS E4 only with Multi-Voltage.

## 5 Braking system

### 5.1 System design

The Trailer EBS E braking system is an electronically controlled braking system with load-dependent braking pressure control, automatic anti-locking system (ABS) and electronic stability control (RSS).

**!** Trailer vehicles equipped with a trailer EBS E braking system may only be towed by towing vehicles with an extended ISO 7638 plug connection (7-pin; 24 volts; towing vehicles with CAN data line) or with an ISO 7638 plug connection (5-pin, 24 volts; towing vehicles with no CAN data line).

A 12 V power supply pursuant to ISO 7638 is only possible with TEBS E Multi-Voltage Modulators.

### 5.2 Scope of application

#### Vehicles

Trailer vehicles with one or more Class O3 and O4 axles pursuant to Directive 70/156/EEC, Annex II, with air suspension, hydraulic suspension, mechanical suspension, disc or drum brakes.

#### Braking systems

Power braking system with a pneumatic or pneumatic-hydraulic transmission system pursuant to Directive 71/320/EEC respectively regulation ECE R 13 or legal regulations (applies only in Germany).

#### Single and twin tires

Identical tire dimensions and the same number of pole wheel teeth must be used for each axle whose rotational speed is being monitored.  
A ratio of tyre circumference to number of pole wheel teeth of  $\geq 23$  to  $\leq 39$  is permissible.

**Example:** For a pole wheel with 100 teeth and a tire rolling circumference of 3,250 mm, the maximum wheel speed that can be processed by the EBS is  $v_{\text{wheel max.}} \leq 160$  km/h.

#### Brake calculation

The Trailer EBS E requires a specific brake calculation for the vehicle or vehicle series. Speak to your WABCO partner.



#### Form "Technical vehicle data for the brake calculation for trailers"

- Open the WABCO INFORM online product catalogue:  
<http://inform.wabco-auto.com>
- Search for the form with the search term "Brake calculation".

## 5.3 Expert reports and standards



### Expert reports

- Open the WABCO INFORM online product catalogue: <http://inform.wabco-auto.com>
- Search for the form with the search term "expert report".

REPORT (LANGUAGE)	SUBJECT
EB123.12E (en)	ABS
EB123_supply.1E	Additional reports for 4 to 10-axle vehicles pursuant to ECE R 13, Annex 20
EB124.6E (includes ID EB 124.5E) (en)	EBS <ul style="list-style-type: none"> <li>■ Extension to ECE R 13, Series 11, Annex 4</li> <li>■ Annex 1, Chapter 3.2.3.1 Electromagnetic Compatibility</li> <li>■ Annex 2 CAN Repeater / CAN Router</li> </ul>
EB167.1E (de, en)	RSS for TEBS E and TEBS D pursuant to ECE R 13 Series 11
TUEH-TB2007-019.01 (de, en)	Trailer EBS E (ADR/GGVs)
RDW-13R-0228 (en)	Comparative Report TEBS D / TEBS E
ID_EB158.0 (en)	Brake release and relaxation function
EB124_CanRou_0E (en)	CAN router
EB171	Immobilizer

STANDARDS	SUBJECT
ISO/TR 12155 DIN 75031	Commercial vehicles and trailer vehicles – Warning devices for manoeuvring – Requirements and tests
DIN EN ISO 228 (Parts 1 - 2)	Pipe threads for connections that are not sealed with the threads
ECE R 13	Directive No. 13 of the Economic Commission of the United Nations for Europe – Uniform conditions for the certification of vehicles regarding the installation of the braking system
ECE R 48 (2008)	Directive No. 48 of the Economic Commission of the United Nations for Europe – Uniform conditions for the certification of vehicles regarding the installation of lighting or light signalling equipment
ISO 1185	Road vehicles – Plug-in connections for electrically connecting towing vehicles and trailer vehicles – 7-pin plug-in connection Type 24 N (normal) for vehicles with 24 V nominal voltage
ISO 4141 (Parts 1 - 4)	Road vehicles – Multi-wire connecting lines
ISO 7638 (Parts 1 - 2)	Road vehicles – Plug-in connectors for the electrical connection of towing vehicles and trailer vehicles – Part 1: Plug-in connectors for braking systems and braking equipment of vehicles with 24 V / 12 V nominal voltage
ISO 11898 (Parts 1 - 5)	Road vehicles – CAN
ISO 11992 (Parts 1 - 2)	Road vehicles – Exchange of digital information via electrical connections between towing vehicles and trailer vehicles
ISO 12098	Road vehicles – Plug connections for electrically connecting towing vehicles and trailer vehicles – 15-pin plug connection for vehicles with 24 V nominal voltage

## 5.4 ABS configurations

COMPONENTS	VEHICLE TYPE	COMMENT
<b>2S/2M</b>		
1x TEBS E Modulator (Standard) 2x ABS speed sensor	1 to 3-axle semitrailer / central axle trailer with air suspension, hydraulic or mechanical suspension	One ABS rotational speed sensor and one TEBS E pressure control channel are combined to form one control channel. All remaining wheels on one side of the vehicle (if present) are controlled indirectly; individual brake force control (IC). During emergency braking, each side of the vehicle is provided with the braking pressure that is possible based on the road conditions and brake characteristics.
<b>2S/2M+SLV</b>		
1x TEBS E Modulator (Standard) 2x ABS speed sensor 1x Select Low Valve (SLV)	1- to 3-axle semitrailer / central axle trailer with air suspension, hydraulic or mechanical suspension and one steering axle	The steering axle is supplied with the respective lower pressure from the pressure control channels via the SLV, so that the axle remains stable even in $\mu$ -split situations (different friction on each side).
<b>4S/2M</b>		
1x TEBS E Modulator (Premium) 4x ABS speed sensor	2 to 5-axle semitrailer / central axle trailer with air suspension, hydraulic or mechanical suspension	Two ABS rotational speed sensors are arranged on each side of the vehicle. Each side of the vehicle is controlled individually. The braking pressure is the same for all wheels on one side.  The two sensed wheels on this side of the vehicle are regulated according to the principle of modified side control (MSR). In this case, the first wheel to lock on one side of the vehicle is the determining factor for the ABS control.  The principle of individual control (IC) is applied with regard to both sides of the vehicle.
<b>4S/2M+1M+SHV</b>		
1x TEBS E Modulator (Premium) 4x ABS speed sensor 1x ABS relay valve 1x double non-return valve (SHV)	2 to 5-axle semitrailers / 2 to 3-axle central axle trailers with air suspension, hydraulic or mechanical suspension and one steering axle	Two ABS rotational speed sensors, one SHV and an ABS relay valve are arranged on the steering axle.  The steering axle is controlled according to the modified axle regulation (MAR) principle and the other axle according to the principle of individual control (IC).
<b>4S/3M</b>		
1x TEBS E Modulator (Premium) 4x ABS speed sensor 1x EBS relay valve	2 to 5-axle drawbar trailers / 2 to 5-axle semitrailers / 2 to 3-axle central axle trailers with air suspension and one steering axle	Two ABS rotational speed sensors and one EBS relay valve are arranged on the front axle. The steering axle is controlled according to the modified axle regulation (MAR) principle. The wheel on the steering axle which tends to lock up first is dominant for the ABS control.  One ABS rotational speed sensor and one TEBS E pressure control channel are used on an additional axle to control each side separately. These wheels are individually controlled (IC).



## Multi-axle units

Axles or wheels that are not being sensed are controlled by directly regulated axles or wheels. Multi-axle units require almost identical adhesion utilisation on these axles when braking.

If not all the wheels are being sensed, those axles that have the greatest tendency to lock up need to be fitted with ABS rotational speed sensors.

Multi-axle assemblies with static axle load allocation only should be equipped in such a way (brake cylinders, length of brake levers, etc.) that the wheels of all axles reach the locking limit as simultaneously as possible and a directly controlled wheel does not indirectly control more than two wheels or one axle.

## Lifting axles

2S/2M: Lifting axles must not be monitored.

All other system configurations with at least 4S with the exception of drawbar trailers: Lifting axles can be fitted with ABS rotational speed sensors e-f.

---

2 axle vehicles with two lifting axles are supported as a 4S/2M system.

TEBS E automatically detects which axle is lifted and uses the axle on the ground as the main axle ▶ chapter "6.24 Forklift control", page 120.

---

## Tag axles

Vehicles with tag axles must be equipped with a 4S/2M+1M or 4S/3M system to prevent the tag axle from locking up.

This also applies to vehicles where an axle is only temporarily relieved, for example when using the traction help or OptiTurn™.

If the frame is more rigid (e.g. box bodies), a 4S/3M system must be used to prevent the outside wheel from locking up when braking in bends.

## Steering axles

Positively controlled axles are to be treated as rigid axles.

WABCO recommendation: Trailers with self-steering axles are configured with 4S/3M, 4S/2M+1M or 2S/2M+SLV. If the vehicle is equipped with RSS, one of these configurations must be used to prevent the vehicle from breaking away in a bend when RSS actuates.

2S/2M or 4S/2M EBS systems with steering axles: During the type approval for a trailer, driving tests must be performed to ensure that no impermissible vibrations or course deviations occur. It is not possible to assess the reactions of all the available steering axles during an ABS test. If additional stability is required during ABS operation for a self-steering axle, the steering axle should be switched to rigid using the speed switch (ISS).

# Braking system

## ABS configurations for semitrailers, central axle trailers, dollies and drawbar trailers

### Arrangement of the sensors / modulators

MODULATOR	ABS ROTATIONAL SPEED SENSORS	SYSTEM AXLE	CONTROL TYPE
Trailer	c-d	Main axle (non-lifting)	IR/MSR
Trailer	e-f	Additional axle (lifting)	MSR
ABS / EBS	e-f	Additional axle, steering axle or lifting axle	MAR

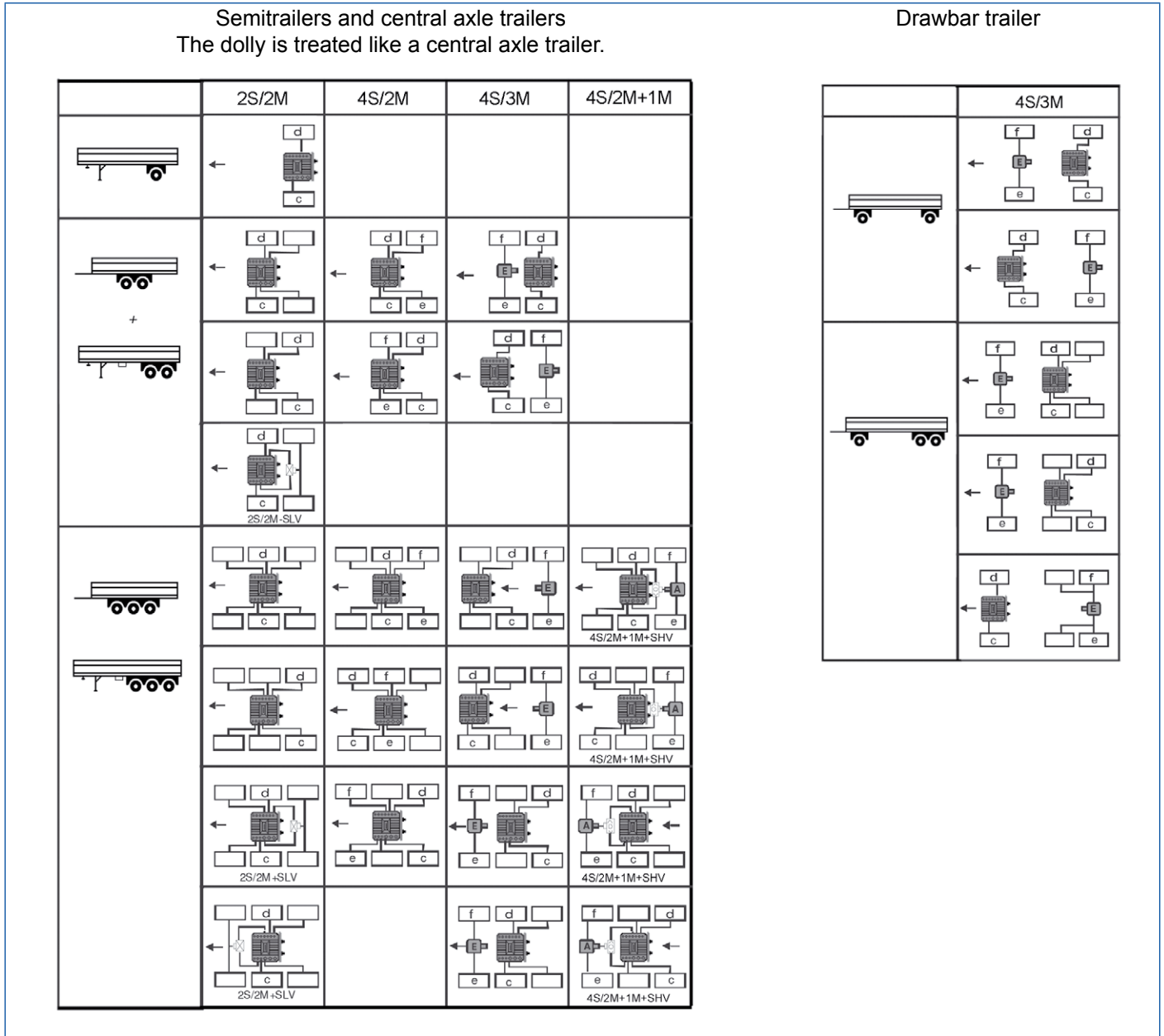

### LEGEND

	Driving direction		Trailer modulator		Select High Valve (SHV)		Sensed wheel (directly controlled)
	EBS relay valve		ABS relay valve		Select Low Valve (SLV)		Non-sensed wheel (indirectly controlled)

## Vehicles with a large number of axles and multiple TEBS E Modulators

Two TEBS E systems can be installed using the CAN router on vehicles with more than 5 axles. For example a 2S/2M and a 4S/3M system can be combined in such cases.

An additional CAN router is required to integrate a third TEBS E Modulator.



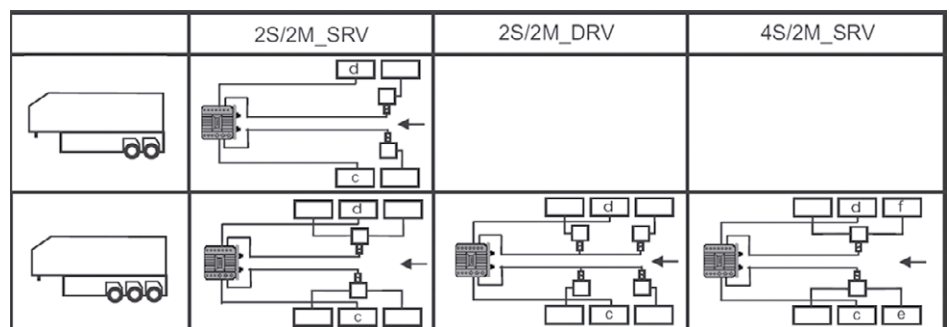

### TEBS E4

All axles of a TEBS E Modulator can be lifted at the same time without the TEBS E signalling a fault with the warning lamp ▶ chapter "5.8 System monitoring", page 35.

## ABS configurations for internal loaders (example: transporting glass panes or concrete slabs)



### LEGEND

<b>SRV</b>	Single relay valve	<b>DRV</b>	Double relay valve
	Trailer modulator		Driving direction
	Sensed wheel (directly controlled)		Non-sensed wheel (indirectly controlled)

Internal loaders have a U-shaped frame with no mechanical connection from the left to the right side of the vehicle in the vicinity of the axle.

The trailer modulator must be installed at the front near the fifth-wheel plate and the brake cylinders are connected using brake lines up to 10 m long.

Additional relay valves must be used to improve the response time and ABS performance.

The overview shows the configurations tested in the ABS report no. EB123.12E. As previously, other configurations must be approved by means of individual acceptance tests.

# Braking system



## Permissible lengths and diameters for hoses and pipes

SEMITRAILERS, CENTRAL AXLE TRAILERS, DRAWBAR TRAILERS AND DOLLY		
Hoses and pipes	Min. diameter	Max. length
Reservoir to trailer modulator	Ø 12 mm *)	*)
Reservoir to relay valve	Ø 9 mm *)	*)
Trailer modulator to brake cylinder	Ø 9 mm	6 m
Relay valve to brake cylinder	Ø 9 mm	6 m





INTERNAL LOADER		
Hoses and pipes	Min. diameter	Max. length
Reservoir to trailer modulator	min. Ø 12 mm	*)
Reservoir to relay valve	min. Ø 9 mm	*)
Trailer modulator to relay valve	max. Ø 9 mm	10 m
Trailer modulator to brake cylinder	min. Ø 9 mm *)	10 m
Relay valve to brake cylinder	min. Ø 9 mm	3 m

! \*) The hoses and pipes between the reservoir and modulator may only be long enough to fulfil the response time pursuant to ECE R 3, Annex 6.





## 5.5 Description of the components of the electro-pneumatic braking system

COMPONENT/PART NUMBER	VEHICLE TYPE	PURPOSE/FUNCTION
<p>TEBS E Modulator 480 102 XXX 0</p>  <p>Overview of variants ▶ chapter "12.1 Pneumatic connections for TEBS E", page 202</p>	<ul style="list-style-type: none"> <li>All trailer vehicles</li> </ul>	<ul style="list-style-type: none"> <li>Control and monitoring of the electro-pneumatic braking system.</li> <li>Side-dependent control of the brake cylinder pressures on up to 3 axles.</li> <li>Control of ABS, RSS etc.</li> </ul>
<p>TEBS E Modulator with flange-mounted Pneumatic Extension Module (PEM)</p> 	<ul style="list-style-type: none"> <li>All trailer vehicles with air suspension</li> </ul>	<ul style="list-style-type: none"> <li>Pneumatic distribution module with integrated charging valve for the air suspension and integrated overload protection valve.</li> <li>The PEM reduces the number of couplings and simplifies installation of the TEBS E braking system.</li> </ul>

# Braking system

COMPONENT/PART NUMBER	VEHICLE TYPE	PURPOSE/FUNCTION
<p>EBS relay valve 480 207 001 0 (24 V) 480 207 202 0 (12 V)</p> 	<ul style="list-style-type: none"> <li>■ Front/rear axle of drawbar trailers or third axle of semitrailers.</li> <li>■ 4S/3M systems</li> </ul>	<ul style="list-style-type: none"> <li>■ Control of braking pressures with sensing of actual braking values.</li> <li>■ Electrical actuation and monitoring are effected by TEBS E.</li> </ul>
<p>ABS relay valve 472 195 037 0 (24 V) 472 196 003 0 (12 V)</p> 	<ul style="list-style-type: none"> <li>■ Third axle of semitrailers</li> <li>■ 4S/2M+1M systems</li> <li>■ The braking pressure produced with this configuration is not monitored.</li> </ul>	<ul style="list-style-type: none"> <li>■ The braking pressure of the axle controlled directly by the TEBS Modulator is used as the control pressure. If the pressure of the TEBS E Modulator is different on either side, the higher pressure is used by means of a Select High valve.</li> <li>■ Electrical actuation (ABS function) by TEBS E.</li> </ul>
<p>Park release emergency valve (PREV) 971 002 900 0 (M 16x1.5; with plate) 971 002 902 0 (M 16x1.5) 971 002 910 0 (Ø 8x1, with test connection) 971 002 911 0 (2x Ø 10x1; 3x Ø 8x1) 971 002 912 0 (Ø 8x1; with plate and test connection) 971 002 913 0 (3x Ø 10x1; 2x Ø 8x1)</p> 	<ul style="list-style-type: none"> <li>■ All trailer vehicles</li> </ul>	<ul style="list-style-type: none"> <li>■ Functions of the trailer brake valve and the double release valve combined in one unit (including emergency brake function).</li> </ul>
<p>Select Low valve (double shut-off valve) 434 500 003 0</p> 	<ul style="list-style-type: none"> <li>■ Vehicles with 2S/2M+Select Low control, e.g. with steering axle.</li> </ul>	<ul style="list-style-type: none"> <li>■ The pressures applied are the pressures outputted by the trailer modulator for each side. The lower pressure is directed to the axle to be braked.</li> </ul>

# Braking system

COMPONENT/PART NUMBER	VEHICLE TYPE	PURPOSE/FUNCTION
<p>Select High valve Double non-return-valve / two-way valve 434 208 055 0</p> 	<ul style="list-style-type: none"> <li>■ Vehicles with 4S/2M+1M system for actuating the separate ABS relay valve.</li> </ul>	<ul style="list-style-type: none"> <li>■ The pressures applied are the pressures outputted by the trailer modulator for each side. The higher pressure is fed to the ABS relay valve.</li> </ul>
<p>ABS rotational speed sensors 441 032 808 0 (0.4 m) 441 032 809 0 (1 m)</p> 	<ul style="list-style-type: none"> <li>■ All trailer vehicles</li> <li>■ Installation: on the brake anchor blades of the axles or main axles.</li> </ul>	<ul style="list-style-type: none"> <li>■ Detection of the movement status of a rotating pole wheel together with the vehicle wheel.</li> </ul>
<p>Pressure sensors 441 044 101 0 441 044 102 0</p> 	<ul style="list-style-type: none"> <li>■ All trailer vehicles</li> <li>■ Installation: on one of the support bellows of the axle to be monitored</li> </ul>	<ul style="list-style-type: none"> <li>■ Axle load measurement.</li> <li>■ Measurement of pressure at the yellow coupling head.</li> </ul>
<p>CAN router 446 122 050 0 (plug socket) 446 122 056 0 (plug socket; with connection for nominal pressure sensor) 446 122 052 0 (plug connector) 446 122 054 0 (plug connector; with connection for nominal pressure sensor)</p> 	<ul style="list-style-type: none"> <li>■ Truck-trailer combinations with multiple trailer braking systems (longer heavier vehicles or road trains).</li> <li>■ Between the towing vehicle/trailer interface and TEBS E Modulator(s).</li> </ul>	<ul style="list-style-type: none"> <li>■ Power supply and distribution of the CAN signals to multiple TEBS E Modulators.</li> <li>■ Up to four CAN routers in series can supply up to five TEBS E Modulators.</li> <li>■ By connecting an optional pressure sensor, the brake/control pressure is measured in the vicinity of the coupling head and is sent as a CAN signal to the TEBS E Modulator(s) connected to the outputs, to guarantee optimal response times even without an EBS towing vehicle.</li> </ul>

COMPONENT/PART NUMBER	VEHICLE TYPE	PURPOSE/FUNCTION
CAN repeater 446 122 051 0 (plug socket) 446 122 053 0 (plug connector) 	<ul style="list-style-type: none"> <li>For special vehicles with non-compliant cable lengths, e.g. telescoping low-beds or long-log transporters.</li> <li>Between the towing vehicle/trailer interface and TEBS E Modulator.</li> </ul>	<ul style="list-style-type: none"> <li>Amplification of the CAN signal to ensure that data can be sent to the connected TEBS E over greater distances.</li> </ul> <p><b>Note: ISO 11992 stipulates a maximum length of 18 m for the wiring in the trailer. The cable length for Trailer EBS E together with the CAN repeater can be up to 80 m.</b></p>
Cable		<ul style="list-style-type: none"> <li>Connecting the components</li> <li>Cable overview ▶ chapter "12.3 Cable overview", page 209.</li> </ul>

## 5.6 TEBS E Modulator components

The TEBS E Modulator is a controller electronics system with four input channels for rotational speed sensors and one "Towing vehicle" CAN interface.

The components of the modulator are:

- An internal pressure sensor "Braking pressure"
- An internal pressure sensor "Axle load"
- A backup valve for emergency operation if the power fails
- Two modulators for controlling the brake cylinders
- Two internal pressure sensors for measuring the pressures for the brake cylinder
- One control output for controlling another axle
- One internal pressure sensor for monitoring the supply pressure
- One lateral acceleration sensor for monitoring the driving stability

## 5.7 Supply

The Trailer EBS E is activated electrically via pin 2 of the ISO 7638 plug connection (terminal 15) and then supplied with power via pin 1 (terminal 30).

 <b>WARNING</b>	<p><b>Increased risk of accidents due to locking wheels as well as delayed braking effect</b></p> <p>The ABS, EBS and RSS control functions are not available if the ISO 7638 plug connection to the towing vehicle is not connected.</p> <ul style="list-style-type: none"> <li>– <i>Instruct the driver by suitable means with regard to this circumstance (e.g. adhesive label, operating instructions).</i></li> </ul>
--	--



## 5.7.1 Function test when switching on or coupling

Two seconds after the Trailer EBS E is switched on, a system check is performed during which the solenoids can be heard to briefly switch on and off.

! If the system check is not audible when the 7 or 5-pin ISO 7638 plug connection is plugged in, there is a problem in the power supply between the towing vehicle and the TEBS E (terminal 15, 30 or ground connection of the coiled cable or power cable to the Trailer EBS Modulator).

Consequence: The modulator is not being supplied with voltage.

Remedy: Drive with the utmost care to the nearest workshop.

## 5.7.2 Power supply from stop light (24N)

In the event of a failure of the power supply at the ISO 7638 plug connection, the TEBS E braking system can be optionally supplied with power from the stop light (24N at the IN/OUT terminal) as a safety function.

Pursuant to ECE R 13, power cannot be solely supplied with power from the stop light. Please note that the RSS function and the GIO outputs are not active while the vehicle is being driven if power is being supplied via 24N or ISO 12098. This means that the ECAS control integrated in TEBS is also inactive.

The following functions are available if the ECU is only being supplied with power from the stop light during a braking procedure when the vehicle is moving:

- the load-related braking force distribution (LSV function)
- the ABS with limited, delayed control characteristics
- the ISS output for actuating a rotary slide valve with RtR function (TASC)
- the ECAS RtR function

## 5.7.3 Operation powered by battery in trailer vehicle

The Trailer EBS can be operated using a 24 V battery connected to the IN/OUT terminal. All the functions can be used.

The battery cannot be charged directly via the TEBS E Modulator.

## 5.7.4 Multi-Voltage

### Vehicle type

TEBS E1.5

Semitrailer, central axle trailer with maximum 4S/2M system.

TEBS E2

Semitrailer, central axle trailer with maximum 4S/2M+1M system.

TEBS E2.5

Semitrailer, central axle trailer and drawbar trailer with 4S/3M system.

## Purpose

The TEBS E Modulator (Multi-Voltage) 480 102 08X 0 can be operated with both 12 V and 24 V towing vehicles.

**!** The TEBS E Multi-Voltage does support the PLC communication commonly found in towing vehicles in the United States. This may mean that TEBS E warnings are not displayed on the dashboards of U.S. trucks.

### Connecting the TEBS E Modulator (Multi-Voltage) with the towing vehicle

For installation and use in mixed operation, an extra 12 V coded connection socket must be installed in addition to the 24 V coded ISO 7638 plug connection:

- 24 V socket with CAN signal (446 008 380 2 or 446 008 381 2)  
Use the power cable 449 173 XXX 0 to connect the 24 V socket, for example.
- 12 V socket without CAN signal (446 008 385 2 or 446 008 386 2)  
Use a 5-pin (or 7-pin) cable to connect the 12 V socket.
- 12 V socket with CAN signal (446 008 385 2 or 446 008 386 2)  
Use a 5-pin cable (or 7-pin cable for 12 V CAN support) to connect the 12 V socket.

A 'Y' power cable must be made using a cabling box to connect the 24 V and the 12 V connection.

## Functions with multi-voltage capability

Because there is normally no CAN signal in 12 V towing vehicles, the "Brake" control pressure is only transferred to the trailer pneumatically.

The following components can be connected:

- External pressure sensors at GIO1 or GIO3
- Buttons and switch inputs (e.g. for road finisher brakes) at GIO1 to GIO7
- Brake lining wear indicator (BLWI) at GIO1 to GIO4 or GIO6 to GIO7
- SmartBoard or OptiTire™ at SUBSYSTEMS

Different GIO functions are available depending on the TEBS E version. 12 V valves are connected for these functions.

FUNCTIONS WITH MULTI-VOLTAGE CAPABILITY	COMPONENT	FROM TEBS E VERSION
Lifting axle control	Lifting axle valve 463 084 050 0	TEBS E2
4S/2M+1M systems	ABS relay valve 472 196 003 0	TEBS E2
4S/3M (drawbar trailer)	EBS relay valve 480 207 202 0	TEBS E2.5
ECAS	eTASC 463 080 5XX 0	TEBS E2.5
ECAS	Rear axle valve 472 880 072 0	TEBS E4
TailGUARD™	Electronic Extension Module 446 122 070 0	TEBS E2
OptiTurn™	Tag axle valve 472 195 066 0	TEBS E4

## Battery operation

Multi-voltage systems can only be connected to 12 V batteries in the trailer (using the electronic extension module or directly).

The charging function for the battery is only available while the trailer is being supplied with 12 V.

The Wake-up function is not available when the vehicle is being supplied with 24 V.

---

! Connecting 12 V components to GIOs other than those specified in the circuit diagrams can destroy system components.

---

## 5.8 System monitoring

### 5.8.1 Warnings and system messages

#### Light signal messages after switching on the ignition

Pursuant to ECE R 13, two reactions are permitted when switching on the ignition and can be configured using the TEBS E diagnostic software.

##### Variant 1

The warning lamp / warning indicator in the towing vehicle lights up after the ignition is switched on.

If no current fault is detected, the warning lamp / warning indicator goes out after approx. 2 seconds. Trailer EBS E is operational.

If a current fault was detected, such as a sensor error, the warning lamp / warning indicator stays on.

If a sensor fault was detected during the last drive, the warning lamp / fault indicator goes out at speeds  $v > 7$  km/h.

If the warning lamp / warning indicator does not go off even after starting to drive, the driver must have the fault rectified at a workshop.

##### Variant 2

The warning lamp / warning indicator in the towing vehicle lights up after the ignition is switched on.

The warning lamp / warning indicator goes off at a speed of  $v \geq 7$  km/h.

If the warning lamp / warning indicator does not go off even after starting to drive, the driver must have the fault rectified at a workshop.

#### Warnings and system messages

If the yellow or red warning lamp / warning indicator on the instrument panel lights up or flashes while driving, this indicates a warning or a system message.

**Yellow warning lamp / warning indicator:** Actuated by pin 5 of the ISO 7638 plug connection and over the CAN bus

**Red warning indicator / warning lamp:** Actuated over the CAN bus of the ISO 7638 plug connection

Any events that occur during operation are stored in the Trailer EBS E and can be read out in the workshop using the TEBS E diagnostic software.

- ! The warning lamp / warning indicator must be monitored by the driver.
- If the warning lamp / warning indicator lights up, a visit to the workshop is necessary. The instructions on the display must be observed if applicable.

The faults are displayed according to the fault's priority level. The priority level of the faults is grouped into five classes:

**Class 0:** Minor, temporary faults are indicated by a yellow warning lamp / warning indicator.

**Class 1:** Average faults, which cause partial functions (e.g. ABS) to be deactivated, are indicated by a yellow warning lamp / warning indicator.

**Class 2:** Severe faults in the braking system are indicated by a red warning lamp / warning indicator.

**Class 3:** Minor faults that can cause deactivation of GIO functions (such as speed signal) are indicated by the yellow warning lamp / warning indicator flashing after the respective function is switched on.

**Class 4:** Minor faults that can cause deactivation of GIO functions (such as the remote control unit). The warning lamp / warning indicator does not light up.

## Warning signal sequences for power supply via ISO 1185 / ISO 12098

Power can be supplied via ISO 1185 (24N, light) or ISO 12098 as a safety function in order to maintain important control functions in the event of a power supply failure at the ISO 7638 plug connection.

If the ISO 7638 plug connection fails completely, a warning cannot be sent via pin 5.

If the connection via pin 5 is intact, the warning lamp / warning indicator is actuated and the driver is warned.

## Warning signal sequences in the event of unspecified faults pursuant to ECE R 13

Following the switching-on procedure and the warning lamp / warning indicator test, the warning lamp / warning indicator will flash in the event of non-specified faults pursuant to ECE regulations.

The warning indicator / warning lamp no longer lights up when the vehicle's speed exceeds 10 km/h.

The following states can cause the warning lamp / warning indicator to flash:

- Immobilizer activated
- Electronic parking brake activated
- Service interval reached (BLWI)
- Brake lining worn
- Current class 3 faults (e.g. ECAS faults)
- Tire pressure loss (OptiTire™)

## Warning signal with ignition on without motion detection

TEBS E switches on the warning lamp / warning indicator 30 minutes after the ignition has been turned on if no speed is detected via the wheel sensors. This can cause warning lamps on vehicles fitted with multiple TEBS E systems to be actuated when all the axles monitored by a system are lifted and therefore no speed is detected.

## TEBS E4

From TEBS E4, a preconfigured setting in the TEBS E diagnostic software in *tab 8, General Functions* causes the TEBS E to only trigger a warning if a wheel speed is not detected despite a detected axle load. Alternatively, the previous function (warning after 30 minutes) can be configured.

## Reservoir pressure monitoring

### Application

Integrated function in TEBS E Modulator.

### Purpose

Monitoring the supply pressure by TEBS E.

### Function

**Warning indicator / warning lamp:** If the supply pressure drops below 4.5 bar in the trailer vehicle, the driver is warned by the warning indicator / warning lamp (red and yellow) lighting up. If this is the case while in motion, a message is also saved in the diagnostic memory. The fault indicator / warning lamp only goes out if the supply pressure exceeds 4.5 bar again.



### WARNING

#### Risk of accidents caused by low supply pressure (< 4.5 bar)

The vehicle can no longer be braked by means of the service brake. If the pressure at the coupling head is below 2.5 bar, the vehicle is automatically braked by the spring chambers.

- *As soon as the warning indicator / warning lamp (red and yellow) lights up, the vehicle must be stopped and parked in a safe place.*
- *The pressure supply must be checked and a repair service called as required.*

## 5.8.2 Pneumatic redundancy

In the event of a system fault requiring a (partial) shut-down of the overall system, the pneumatic control pressure is switched through to the brake cylinder directly, but without consideration of the axle loads (LSV). The ABS function is maintained to the greatest possible extent.

**Warning indicator / warning lamp:** The driver is notified of the system status by a red warning indicator / warning lamp lighting up.

## 5.9 Brake functions

With no power supply, the control pressure is sent directly to the brake cylinders via the yellow coupling head. The backup valve, which is integrated in the TEBS E Modulator and separates the control pressure from the pressure control circuits in normal operation, remains open.

When the Trailer EBS E is functional, the backup valve is pressurised at the beginning of a braking procedure and therefore the control line from the yellow coupling head is disconnected from the pressure control of the Trailer EBS E

Modulator. The pressure is now regulated by the pressure control circuits according to the nominal value detection and load situation.

## 5.9.1 Nominal value detection

The braking request from the driver is referred to as the nominal value.

If the system is being operated behind an EBS towing vehicle with a 7-pin (ABS) plug connection pursuant to ISO 7638, the Trailer TEBS E acquires the nominal value from the EBS towing vehicle via the trailer interface (CAN).

If no nominal value is available via the trailer interface, e.g. when operating the trailer vehicle behind a towing vehicle with a convention braking system, a nominal value is created by measuring the control pressure at the yellow coupling head. This is done either via the nominal pressure sensor integrated in the TEBS E Modulator or optionally using an external sensor. An external nominal pressure sensor is especially recommended with exceptionally long trailer vehicles to eliminate the delay caused by long lines.

To enable the pressure in the trailer vehicle to build up as quickly as possible, the nominal value received via the CAN bus (ISO 7638, pins 6 and 7) is always prioritised for control purposes.

In order to adapt the brake forces to various load status, the axle loads on vehicles with air suspension and vehicles with hydraulic suspension are measured by sensing the bellows pressures. For mechanically suspended vehicles, the load status is determined by measuring the compression travel with one height sensor or two height sensors ▶ chapter "5.9.2 Load Sensing Valve (LSV)", page 40.

### Nominal value via CAN at 12 V

#### TEBS E2

From TEBS E2, it is possible to configure whether data from the CAN bus is to be ignored with a supply voltage of < 16 V.

This function is activated in the TEBS E diagnostic software in *tab 8, General Functions*.

### 5.9.1.1 External nominal pressure sensor





#### Vehicle type

All trailer vehicles, particularly where there is a great distance between the yellow coupling head and the TEBS E Modulator.

#### Purpose

Improvement in the response times for towing vehicles without EBS (no CAN signal).

## Components

PART NUMBER	FIGURE	DESCRIPTION
480 102 06X 0		TEBS E Modulator Premium
441 044 101 0 441 044 102 0		<p>Nominal pressure sensor</p> <ul style="list-style-type: none"> <li>■ 0 to 10 bar</li> <li>■ <b>Use only at the responsibility of the vehicle manufacturer, depending on the vehicle construction.</b></li> <li>■ The GIO terminals are assigned using the TEBS E diagnostic software.</li> <li>■ Cable for nominal pressure sensor: 449 812 XXX 0</li> </ul>
446 122 05X 0	<p>CAN router</p>  <p>CAN repeater</p> 	<p>CAN router and CAN repeater</p> <ul style="list-style-type: none"> <li>■ A detailed description of the CAN router and CAN repeater can be found in the relevant documentation ▶ chapter "Technical documents", page 8.</li> </ul>

## Installation

The external desired-pressure sensor is connected directly to the control line on the front of the vehicle or directly to the CAN router or CAN repeater ▶ chapter "5.5 Description of the components of the electro-pneumatic braking system", page 29.

**!** The nominal pressure sensor cannot be connected to the electronic extension module.

## Parameter setting

This function is activated in the TEBS E diagnostic software in *tab 8, General Functions*.

## 5.9.2 Load Sensing Valve (LSV)

### 1-circuit axle load determination

#### Vehicle type

Trailer vehicles with air and leaf-spring suspension.

#### Purpose

Trailer EBS E includes a load-dependent braking pressure control, with which the braking pressure is adapted to the load status. Characteristic curves are saved as defined in the Parameter setting based on the braking calculations.

The actual load status is determined by sensing the air-suspension bellows pressure and the hydraulic pressure, evaluating the compression travel on a mechanical suspension, or by calculating the rotational speed differentials of the wheel speeds on two, rotational speed-sensed axles.

Semitrailers and drawbar trailers are controlled differently.

---

**!** In the case of vehicles that could have differing lateral pressures while they are being driven, it must be ensured that the higher bellows pressure is always used to control the braking force, because otherwise the vehicle may not attain the required braking deceleration. This is achieved by connecting the bellow pressures on both sides of the vehicle to the TEBS E Modulator via a Select High valve.

A better solution, however, is to determine the mean value with the aid of a second axle load sensor as described in the next section.

---

### 2-circuit axle load determination (right / left)

#### Vehicle type

Air suspension trailer vehicles.

#### Purpose

This function enables the creation of a right-left average value of the axle loads. This improves the braking behaviour of the trailer (more precise determination of the actual load status). An additional axle load sensor is installed on the main axle, which then has to be configured in the TEBS E diagnostic software in *tab 8, General Functions*, as a *second external axle load sensor c-d*.

### Determining the axle loads

The axle load of main axle c-d can be determined with the following options:

- Measuring the air spring pressure on air suspension vehicles with a pressure sensor integrated in the modulator
- Measuring the air spring pressure on air/hydraulic suspension vehicles using an external pressure sensor (configuration in the TEBS E diagnostic software: *External axle load sensor c-d*)
- Measuring the compression travel on mechanical suspension vehicles using a height sensor

The axle load of additional axle e-f can be determined with the following options:

- Measuring the air spring pressure on air/hydraulic suspension vehicles using an external pressure sensor



# Braking system

- Measuring the compression travel on vehicles with a mechanical suspension using a distance sensor (configuration in the TEBS E diagnostic software: *External axle load sensor e-f*)
- Determining the axle load for 4S/3M systems using slip rate detection

## Safety function "Vehicle on buffer"

- If the bellows pressure is below 0.15 bar and less than 50 % of the defined empty bellows pressure (always the lower value), the LSV characteristic curve "Laden" is controlled because the vehicle frame is probably resting on the buffers of the axle and no reliable conclusion can be drawn regarding the load status.

## Characteristic curves

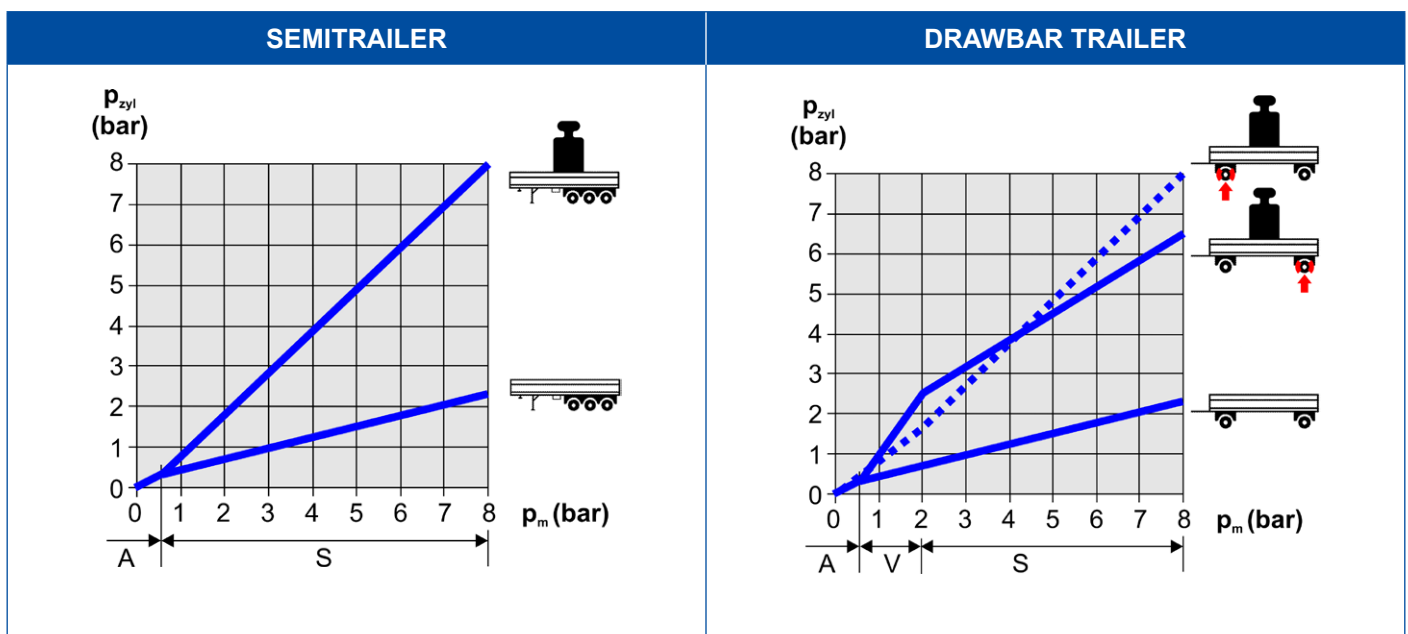

A = application range; V = wear range; S = stability range

In this example, the nominal value or control pressure ( $p_m$ ) increases in the application range from 0 bar to 0.7 bar. With this control pressure, the braking pressure ( $p_{cyl}$ ) increases from 0 to 0.4 bar.

At 0.7 bar, the response pressure in the wheel brake is reached and so the vehicle can now begin to build up braking force. This point, being the response pressure of the entire trailer brake, can be set in the parameters within EC braking bands.

The deceleration band stipulates the range in which the deceleration (in %) must be at a certain control pressure  $p_m$ .

During the course of the braking action, the braking pressure follows a straight-line characteristic for the laden vehicle through the calculated value at 6.5 bar.

When the vehicle is unladen, the response pressure is likewise applied at 0.7 bar. Afterwards, the braking pressure is reduced relative to the load.

The response pressures of the brakes are once again output at the limit of the application range. These pressures may also differ from one axle to another. In the partial braking range pressures are delivered for optimum wear.

In a drawbar trailer with type 24 cylinders on the front axle and type 20 cylinders on the rear axle, for example, the pressure at the front axle is slightly reduced and that at the rear axle is slightly increased in accordance with the configuration. This ensures that the load is distributed evenly between all wheel brakes and is more exact than the function of the adapter valve used with conventional braking systems.

In the stability range, the pressures are output in such a way as to ensure the same adhesion utilisation (possible adhesion utilisation) as a function of the axle load.

## Parameter setting

The LSV data is entered in the TEBS E diagnostic software in *tab 3, Braking Data*.

Generally, the definition of a linear characteristic is sufficient.

In special cases a special characteristic can be defined by means of an additional characteristic point.

By default, three values are preset:

RANGES	PRESSURE AT YELLOW COUPLING HEAD (CONTROL PRESSURE OR NOMINAL VALUE)	CALCULATED DECELERATION OF THE VEHICLE
Application range	$p \leq 0.7 \text{ bar}$	0 %
Wear range	$0.7 \text{ bar} < p \leq 2.0 \text{ bar}$	at 2 bar: 12.6 %
Transition range	$2.0 \text{ bar} < p \leq 4.5 \text{ bar}$	at 4.5 bar: 37 %
Stability range	$4.5 \text{ bar} < p \leq 6.5 \text{ bar}$	at 6.5 bar: 56.5 %

The braking pressure level control is adapted proportionally to the measured vehicle load.

The aim is to achieve a deceleration of 55 % during all load status and when the pressure at the yellow coupling head (control pressure or nominal value) is 6.5 bar.

## Pressure sensor for hydraulic suspension

The pressure sensor has to be selected based on the pressures that occur. The signal output must be linear between 0.5 and 4.5 V.

Hydraulic pressure: 0 bar = 0.5 V

Maximum supply pressure = 4.5 V

! Various manufacturers supply matching pressure sensors, such as WIKA (model 894.24.540 with measuring range of hydraulic pressure 25 to 1,000 bar) or Hydac (pressure transducers HDA 4400, measuring range 250 bar).

Next to the pressure range, the pin assignment on the electrical port must be checked.

### Example

"unladen" hydraulic bellows pressure = 50 bar

"laden" hydraulic bellows pressure = 125 bar

What is required is the pressure input for the TEBS E LSV parameters *laden* and *unladen*.

### Default

Search for hydraulic pressure sensor, which corresponds with the measuring range from 125 bar.

"Hydraulic" pressure sensor: 0 to 250 bar => 0.5 to 4.5 V

WABCO standard EBS pressure sensor "pneumatic" as comparison value:  
0 to 10 bar => 0.5 to 4.5 V

## Calculation

Range of measurement 250 bar: WABCO standard EBS pressure sensor 10 bar = 25 bar

Parameter value for bellows pressure "laden"

=>  $125 \text{ bar} / 250 \text{ bar} * 10 \text{ bar} = 5 \text{ bar}$

Parameter value for bellows pressure, "unladen"

=>  $50 \text{ bar} / 250 \text{ bar} * 10 \text{ bar} = 2 \text{ bar}$

### TEBS E4

The hydraulic pressure is converted to the pneumatic reference pressure in the TEBS E diagnostic software and simplifies configuring the parameters.

Deviations in the calculation of the parameter values are also produced by rounding or down within the binary numeric system.

## 5.9.2.1 Mechanical suspensions

### Vehicle type

Vehicle with leaf spring suspension (mechanical suspension).

### Purpose

Determining the axle loads.

### Function





The axle load information for the LSV function is derived from the compression travel of the axle combination. ECAS height sensors are used for this purpose. In this particular case of application the sensor delivers a signal that is proportional to the suspension travel and therefore the current axle load.

Further information ► chapter "5.9.2 Load Sensing Valve (LSV)", page 40.

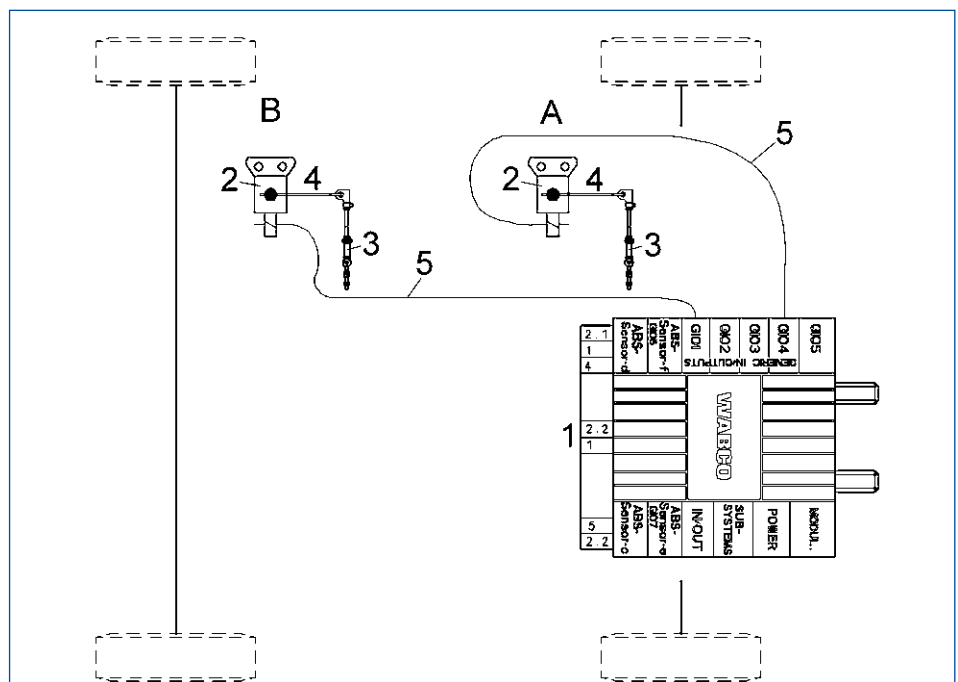
### Connecting the components

#### Extract from schematic diagram 841 802 154 0



ITEM	PART NUMBER	FIGURE	DESCRIPTION
1	480 102 06X 0		TEBS E Modulator Premium <ul style="list-style-type: none"> <li>■ Installation: Possible on front or rear axle</li> </ul>
2	441 050 100 0		Height sensor <ul style="list-style-type: none"> <li>■ Installation: Height sensor A on axle c-d; height sensor B on axle e-f</li> </ul>
3	441 050 71X 2		Linkage <ul style="list-style-type: none"> <li>■ Available in different lengths</li> </ul>
4	441 050 718 2 441 050 641 2		Lever <ul style="list-style-type: none"> <li>■ Extension for height sensor lever</li> </ul>
5	449 811 XXX 0		Cable for height sensor

## Installation

Information on installation ▶ chapter "8.6 Installing the height sensor", page 158.

## Parameter setting

The definition of a vehicle with mechanical suspension is entered in the TEBS E diagnostic software in *tab 2, Vehicle*.

A name is assigned to the GIO terminal for the height sensor in *tab 11, Connectors*.

## Calibration

Information on calibrating ▶ chapter "9.5.1 Calibration for vehicles with mechanical suspension", page 179.

### 5.9.3 Pressure control

The pressure control circuits take the nominal pressures specified by the LSV function and convert them into cylinder pressures.

The TEBS E Modulator takes the actual value pressures measured at the output of the relay valves and compares them with the nominal pressure.

If there is a discrepancy, this is compensated for by actuating the inlet or exhaust solenoids of the modulator or the 3rd modulator.

If the measured supply pressure exceeds 10 bar, the pressure control and ABS control are deactivated and the vehicle is only braked redundantly.

**!** In accordance with the EC directives and ECE regulations, a maximum of 8.5 bar supply pressure is permitted in the trailer.

## Pneumatic advanced response and CAN advanced response

An advanced response can be defined for truck-trailer harmonisation and harmonising the brake pad wear.

The values for the pneumatic advanced response and CAN advanced response can vary.

## Parameter setting

The advanced response is entered in the TEBS E diagnostic software in *tab 3, Braking Data*.

## 5.9.4 Overload protection

### Vehicle type

All vehicles with spring-loaded cylinders.

### Purpose

To protect the wheel brake from overloading (added force) when the service and spring chamber brakes are applied simultaneously.

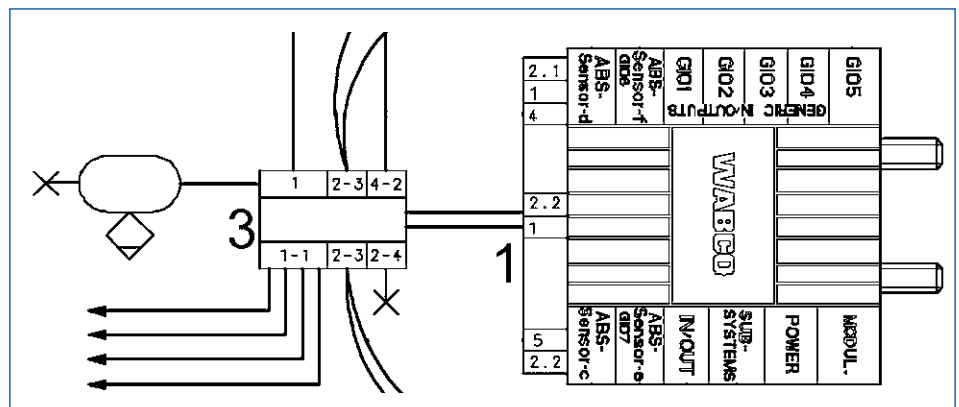

### Connecting the components

The relay overload protection valve is already integrated in the PEM:

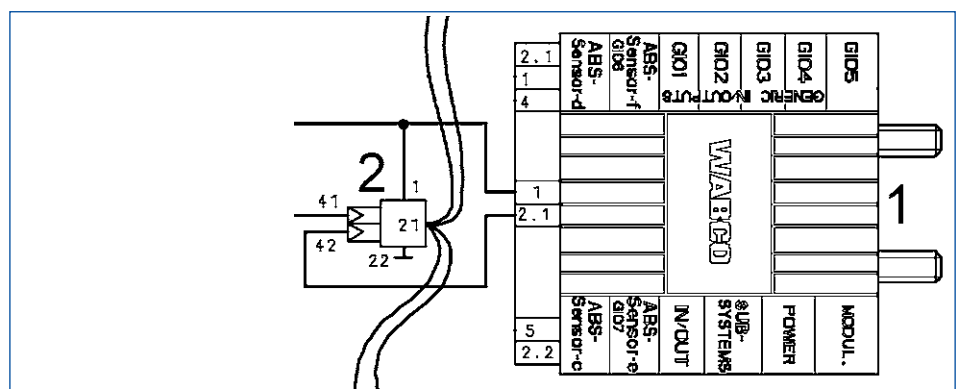

In the absence of a PEM, overload protection must be ensured using a separate relay overload protection valve:

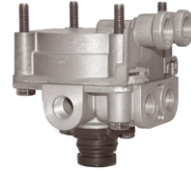

ITEM	PART NUMBER	FIGURE	DESCRIPTION
1	480 102 0XX 0		TEBS E Modulator
2	973 011 XXX 0		Relay overload protection valve
3	461 513 00X 0		PEM

## 5.9.5 Anti-Lock Braking System (ABS)

### Vehicle type

All trailers.

### Purpose

ABS prevents one or more wheels from locking.

### Function

The ABS control logic determines from the wheel rotation speed whether one wheel or more wheels can be locked and decides whether to decrease, maintain, or increase the braking pressure on it.

### ABS rotational speed sensors

Only the signals from ABS rotational speed sensors c-d and e-f are evaluated for the ABS control logic.

In all ABS configurations ( ▶ chapter "5.4 ABS configurations", page 25) additional brake cylinders for other axles can be connected to the existing modulators, besides the brake cylinders on the wheels with sensors. These indirectly controlled wheels do not send any information to the TEBS E. Consequently it is not possible to guarantee that these wheels will not lock.

### Semitrailers, central axle trailers and dolly

The main axle, which is not allowed to be a lifting, steering- or tag axle, always has the c-d ABS rotational speed sensors. The e-f ABS rotational speed sensors are fitted on the other axle or on the semitrailer axles that can be lifted.

## TEBS E4

From TEBS E4 there is exception for 2-axle central axle vehicles with 2 lifting axles. Here one or the other lifting axle can be raised to balance the vehicle in the event of an uneven load. The respectively other axle then becomes the main axle.

### Drawbar trailer

The axles with sensors are not allowed to be either a lifting or tag axle with c-d ABS rotational speed sensors or e-f ABS rotational speed sensors. The c-d ABS rotational speed sensors must always be put on the modulator side. In this case the modulator can either be installed at the front, on the drawbar or at the rear.

The status of the lifting axles is read by the ABS control logic. This means that lifting axles with sensors no longer causes speeds to decrease under ABS control. If the lifting axle is raised, speed information from this axle is not considered when controlling.

### Tire sizes

For optimum function of the ABS control logic it is necessary to parameterise the installed tire dimensions.

A deviation in the defined tire sizes of +15 % / -20 % is permissible if this affects all wheels with sensors to the same extent. A single wheel may only deviate from the parameterised tire size by a maximum of 6.5 %.

### Parameter setting

The tire size is entered in the TEBS E diagnostic software in *tab 3, Braking Data*.

## 5.9.6 Roll Stability Support (RSS)

European legal requirements stipulate that Class O4 trailers with up to 3 axles with air suspension that are certified from July 2010 must be equipped with a stabilisation function. RSS is mandatory as of July 2011 when certifying a vehicle for the first time. With WABCO RSS, all legal requirements concerning safety and traffic are met.

### Vehicle type

All trailers.

### Purpose

Roll Stability Support is a function integrated into the EBS, which introduces the automatic brake application as a preventative measure when there is a danger of tipping, to stabilise the vehicle.

### Function

The RSS function uses the input values of the Trailer EBS E, such as wheel speeds, loading information, and target deceleration, as well as a lateral acceleration sensor that is integrated into the TEBS E Modulator.

For this purpose, test pressure activations are performed for restricted periods at low pressure if the calculated lateral acceleration critical for tilting is exceeded in the trailer. The duration and magnitude of the pressure depend on the lateral acceleration sequence.

The risk of overturning is detected on the basis of the wheel reaction of the wheels braked during a test. If a danger of tilting is detected, brake application at high pressure is initiated in the trailer vehicle at least on the individually controlled (IR) outside wheels in order to reduce the vehicle speed, lateral acceleration, and therefore the danger of tilting or to prevent overturning. The braking pressure for the wheels on the inside of the curve is largely unchanged. As soon as there is no danger of tipping, the RSS brake application is ended.

! On an axle with a modified axle control (MAR), depending on the system it may not be possible to control the braking pressure differently for "right/left". In this case, Select-High control is actuated when a danger of tipping is detected.

RSS control is started in the unbraked or partially braked driving condition. The RSS control is deactivated if the driver brakes heavily enough (deceleration above the level of RSS deceleration).

If the driver defines a pneumatic or electrical braking nominal value for the trailer while an RSS control is taking place, and this is higher than the RSS control, the RSS control is interrupted and the respective nominal value is used for the braking procedure.

The type of pressure control for the wheels on axle e-f depends on the vehicle type and the ABS system configuration.

! The RSS feature requires that the TEBS Modulator is centrally positioned in the vehicle. Details ▶ chapter "8 Installation notes for vehicle construction and retrofitting", page 149.

VEHICLE TYPE AND ABS SYSTEM CONFIGURATION	COMMENT
Semitrailer with trailing steering axles with 4S/3M, 4S/2M+1M or 2S/2M+SLV	<ul style="list-style-type: none"> <li>■ The MAR axle generally brakes with lower or equal pressure to ABS control (for the cornering stability of adhesion-steered axles).</li> </ul>
Drawbar trailer with 4S/3M Semitrailer without trailing steering axle or central axle trailer with 4S/3M or 4S/2M+1M	<ul style="list-style-type: none"> <li>■ During RSS control, the behaviour of the wheel on the inside of the curve is not considered in the ABS logic.</li> <li>■ As long as the inside wheel of the MAR axle is not yet lifted, the MAR axle will be braked with low pressure in order to avoid tire flat spots.</li> <li>■ If the inside wheel of the MAR axle lifts, i.e. indicates a tendency to lock up at low pressure, the pressure increases – depending on the behaviour of both outside wheels.</li> <li>■ The output pressure on the MAR axle can be reduced at the outside wheel by ABS control requirements.</li> </ul>
Vehicles with adhesion-steered steering axle with 2S/2M+SLV (steering axle controlled by a Select Low valve), 4S/2M+1M or 4S/3M+EBS/ABS (MAR-controlled steering axle).	<ul style="list-style-type: none"> <li>■ RSS on vehicles with adhesion-steered steering axle is only possible with the adjacent system configurations.</li> <li>■ An adhesion-steered trailing steering axle must be clicked in the TEBS E diagnostic software.</li> </ul>

## Setting the sensitivity of the RSS function for vehicles where tilting is critical

The sensitivity of the RSS function can be set in the TEBS E diagnostic software.



TEBS E4

Multiple TEBS E Modulators fitted in a special vehicle or road train that communicate with one another via CAN routers coordinate their RSS actuations. This increases the stability of the road train.

## 5.9.7 Standstill function

### Application

Integrated function in TEBS E Modulator.

### Purpose

To avoid unnecessary current consumption if the vehicle is parked with the parking brake applied and the ignition switch actuated.

### Function

When the vehicle stops, braking is done via the redundancy circuit only. The electro-pneumatic pressure control is deactivated. The function is deactivated as soon as the drive begins ( $v > 2.5$  km/h).

## 5.9.8 Emergency braking function

### Application

Integrated function in TEBS E Modulator.

### Purpose

Applying the maximum possible brake force.

### Function

If the braking wish of the driver (electrical or pneumatic) is greater than 90 % of the available supply pressure or  $> 6.4$  bar, i.e. panic braking is evident, a steady increase of braking pressure is applied up to the characteristic curve of the laden vehicle and up to the possible intervention of ABS control.

The emergency braking function is deactivated again once the braking wish drops below 70 % of the available supply pressure.

## 5.9.9 Test mode

### Application

Integrated function in TEBS E Modulator.

### Purpose

Checking the LSV characteristic curve in a stationary vehicle.

### Function

In this test mode, automatically load-dependent brake force control can be checked depending on the hose coupling pressure and the current axle load or the current bellows pressure.

The standstill function and the emergency brake function are deactivated for test purposes.

## Simulation start

- Switch the ignition on with the control line depressurised (service brake system and parking brake system of towing vehicle not actuated), to switch the electronic braking system into test mode.
  - ⇒ The standstill function and the emergency braking function are switched on as soon as the vehicle is moving.

As soon as the vehicle exceeds 10 km/h, the test mode ends.

## Vehicle laden simulation

The "Laden" status can be simulated when the vehicle is unladen by venting the support bellows (< 0.15 bar) or lowering the vehicle onto buffers. The full braking pressures are applied analogue to the safety function "Vehicle on buffer".

Mechanical suspension: Unhook the linkage for the height sensor and turn the lever to the position that corresponds with the spring-deflected vehicle.

## Simulation by diagnosis

The TEBS E diagnostic software can be used to simulate these safety functions from the *Actuation* menu.

## 5.10 ECU-internal functions

### 5.10.1 Odometer

#### Vehicle type

All trailers.

#### Purpose

The Trailer EBS E is equipped with an integrated odometer which measures the distance (in km) covered during a trip. The precision is determined with the tire size relative to the defined tire size.

The odometer requires operating voltage. If the TEBS E is not supplied with voltage, the odometer does not work either and is therefore not secure against tampering.

If a SmartBoard is installed, this also records the driven distance independently of the TEBS E. This odometer keeps working even when the TEBS E is not being supplied with voltage.

Since the odometer in TEBS E counts the average values of all wheels, whereby the odometer in the SmartBoard counts distance on wheel sensor c, different tyre circumferences (tyre wear) can cause the odometer to vary.

No Y-cable is necessary for connecting the wheel sensor c to the SmartBoard, since the connection is already integrated in the SmartBoard cable.

The following individual functions are possible:

#### Cumulative odometer

The cumulative odometer records the entire distance covered since the first installation of the TEBS E system. This value is saved regularly and is read out using the TEBS E diagnostic software or the SmartBoard (sub-menu *Odometer*).

## Trip odometer

The trip odometer can determine the distance travelled between two service intervals or within a specific time span.

The trip odometer can be read out or deleted using the TEBS E diagnostic software or the SmartBoard.

No special calibration of the trip odometer is necessary. A calibration factor is calculated on the basis of the tire rolling circumferences and the number of pole wheel teeth from the EBS parameters.

## Parameter setting

The tire circumferences and number of pole wheel teeth are entered in the TEBS E diagnostic software in *tab 3, Braking Data*.

### TEBS E4

When a modulator is replaced the odometer reading of the new unit can be increased to adjust it to the mileage of the vehicle.

Reducing the odometer reading is not possible. The odometer reading is set in the TEBS E diagnostic software in the menu *Tools, Increase Odometer Reading*.

## 5.10.2 Service signal

### Vehicle type

All trailers.

### Purpose

The service signal is there to remind the driver that service work is due to be performed.

**Warning indicator / warning lamp:** When the vehicle has covered a set distance (e.g. 100,000 km), the yellow warning indicator/warning lamp is activated and flashes 8x when the ignition is switched on again (while stationary or driving). The lamp flashes each time the ignition is switched on. Additionally the service notices are stored in the ECU-internal operating data recorder.

If the service work has been completed successfully, the service signal should be reset in the TEBS E diagnostic software (*Tools, Service Interval*).

If the vehicle reaches the next defined service interval (e.g. 200,000 km), the service signal is generated again.

## Parameter setting

By default, the TEBS E Modulator the service signal is not active.

The interval is activated and entered in the TEBS E diagnostic software in *tab 8, General Functions*.

## 5.10.3 ServiceMind

### Vehicle type

All trailers.

## Purpose

The GIO operating hours counter (ServiceMind) adds together the operating times of the monitored GIO input signals and the outputs switched by TEBS E (e.g. ECAS stand-by times).

**Warning indicator / warning lamp:** When the predefined operating times are reached, an event (service notice) can be started and displayed by the TEBS E diagnostic software or SmartBoard. Optionally, the event can also be outputted via the warning indicator / warning lamp (yellow, ABS) or via an external warning lamp attached to the trailer. As soon as the service notice is displayed, the respective service should be performed on the vehicle.

## Parameter setting

The ServiceMind is entered in the TEBS E diagnostic software in *tab 8, General Functions*.

**Service Name:** You can assign a name to be displayed in the SmartBoard for the monitoring function.

**Service Interval (Hours):** Enter a practicable interval time for the selected component/function here.

**Resettable Service Interval:** The privilege can be granted here for resetting the service interval on the start page in the TEBS E diagnostic software (menu *Tools, Service Interval*) or using SmartBoard. The counter can always be reset in the TEBS E diagnostic software.

**Changeable Service Interval:** The privilege can be granted here for changing the service interval on the start page in the TEBS E diagnostic software (menu *Tools, Service Interval*) or using SmartBoard.

**Input Signal, Internal Signal:** The internal signal can be assigned here to the corresponding GIO function from a dropdown menu. The following functions are supported:

- Stand-by mode
- Reversing lamp
- Output FKA
- Output FKD
- Outputs FCF 1 to FCF 8

You can define whether the operating time of the function should be recorded when it is active or inactive.

**Input Signal, Analogue Signal:** A threshold value (value, as of which the switch is activated) must be assigned to the analogue signal and it must be specified whether the operating time should be recorded above or below this value.

**ABS Lamp Display / External Signal Lamp Display:** Here you can select whether the warning should be indicated via the warning indicator / warning lamp (yellow, ABS) and/or via an external warning lamp attached to the trailer.

## Components

The following components can be used for indication and operation:

PART NUMBER	FIGURE	DESCRIPTION
446 192 11X 0		SmartBoard (optional) <ul style="list-style-type: none"> <li>■ Cable for SmartBoard: 449 911 XXX 0</li> </ul>
446 105 523 2		External green warning lamp (optional)

## 5.10.4 Axle load output

Axle loads can be output via the CAN interface to the towing vehicle, via SUBSYSTEMS to the SmartBoard / to the Trailer Remote Control.

How the loads are displayed in the towing vehicle is dependent on whether the "Trailer axle load display" function is supported and activated. TEBS E generally provides this information.

In the case of vehicles with mechanical suspension, however, the accuracy is restricted by the construction.

The axle load is not outputted or stored in the operating data record (ODR) if the following conditions apply:

- Drawbar trailers with only one axle load sensor on the axle c-d.
- Vehicles with lifting axles that are not being controlled by the TEBS E (mechanical control, control by the Trailer Central Electronic or external ECAS).
- On semitrailers with a tag axle and no additional pressure sensor.

For drawbar trailers with 4S/3M, an additional pressure sensor must be installed on a support bellow of the second axle to detect the axle loads.

An additional axle load sensor can be installed on semitrailers with 4S/2M+1M and 4S/3M to increase the precision of the measurement. In the absence of additional axle load sensors, the single axle load is distributed evenly over all axles.

For the installation of an additional axle load sensor ▶ chapter "6.6 External axle load sensor", page 85.

Transmission of the axle load to the towing vehicle via CAN is configured as default in the TEBS E and can be displayed on the dashboards of most towing vehicles.

If in the case of trailers with two axle load sensors the loading state output is not indicated correctly in the towing vehicle, the transfer of the CAN messages can be adjusted.

## Parameter setting

The settings are configured in the TEBS E diagnostic software in *tab 8, General Functions*.

*EBS22*: No message with the total load from the sum of the single axles is transmitted to the towing vehicle.

*RGE22*: The individual loads of the axles are not transmitted to the towing vehicle.

---

! Transmission of both messages is the default setting.

■ In some towing vehicles faults can occur if the transmitted data appears implausible. One of the messages should be deactivated where this is the case.

---

## Calibration of the axle load output

In order to attain higher precision for the axle load output, the output can be calibrated via the SmartBoard. The calibrated value is transferred to the towing vehicle via the ISO 7638 port and is also displayed on the SmartBoard.

For calibration, an additional characteristic curve based on the weights of an unladen, partially laden and fully laden vehicle. A 3-point characteristic curve is stored in the TEBS E. A detailed description can be found in the SmartBoard system description ▶ chapter "Technical documents", page 8.

---

### TEBS E2

The calibration procedure has been improved so that a message is not stored in the diagnostic memory in the event of a failed calibration.

Optionally 1, 2 or 3 points can be calibrated. Each value can be changed separately, significantly improving the accuracy of the indication.

---

Once a value has been calibrated it is immediately integrated in the characteristic curve for the axle load output. The calibrated minimum/maximum values may only deviate up to max 20 % from the characteristic curve defined by LSV.

The calibrated values for the unladen, partially laden and laden vehicle must not be below a defined minimum distance from one another (minimum of 10 %).

The bellows pressure changes slightly when the vehicle height is changed. Prior to calibration, the vehicle height should therefore be adjusted to the height subsequently relevant for the axle load output. Generally this will be the normal level.

Because the air bellows' properties change over the service life, a recalibration may be required.

---

! Please note that a calibration already started from the SmartBoard must also be concluded as otherwise a fault message is triggered.

---

**Warning indicator / warning lamp:** Optionally, it is also possible to program the unit in the SmartBoard so that the warning indicator / warning lamp (red) flashes in the SmartBoard when the axle load reaches 90 % and 100 % to indicate the danger of overloading, e.g. when loading bulk material.

## Components

The following components can be used for indication and operation:

PART NUMBER	FIGURE	DESCRIPTION
446 192 11X 0		SmartBoard <ul style="list-style-type: none"> <li>■ Cable for SmartBoard: 449 911 XXX 0</li> </ul>
441 044 10X 0		Pressure sensor (optional) <ul style="list-style-type: none"> <li>■ Cable for pressure sensor: 449 812 XXX 0</li> </ul>

## 5.10.5 Notebook function

### Vehicle type

All trailers.

### Purpose

The notebook function enables the user to view, manually process and save TEBS E data (e.g. list of installed components) or vehicle data (service history, e.g. rectified faults, last service date).

The data is stored in table format in the memory of the TEBS E.

### Using the function

- Call up the function in the TEBS E diagnostic software (menu *Tools, Notebook*).

The Notebook function does not require any additional parameter settings or activation.

#### Read data

- Press the button *Read from ECU* to read the data out of the ECU.
- To read the data from a previously prepared (CSV) file, press the button *Read from file*.

CSV file: You can create this file on your PC (using a spreadsheet program for example).

! The data must be alphanumeric (no formatting or special characters). In total, approximately one A4 page can be saved (based on the number of characters), which can be divided into a maximum of 10 columns.

#### Editing data

- If necessary, edit the data using the input mask in the TEBS E diagnostic software.

#### Writing data to the ECU

- To save data in the ECU, press the button *Write to ECU*.

To save data on your PC, press the button *Write to file*.

## 5.10.6 Service documentation (from TEBS E5)

A reference (URL) to service information can be saved in the Trailer EBS Modulator.

Storing such information (e.g. the vehicle wiring diagram) makes it easier for a workshop to pinpoint faults and cuts down the need to contact the manufacturer. The URL is displayed in the TEBS E diagnostic software under the system image after connecting the modulator, and can be opened directly from the diagnostic software providing the workshop computer is connected to the internet.

The information can be a WABCO schematic diagram or a service document from the vehicle manufacturer. A URL with up to 150 characters can be saved. The referenced document can have any number of pages. We recommend storing documents in PDF format.

Example of a reference to the WABCO schematic diagram 841 701 180 0: When the unit is put into operation, the URL <http://inform.wabco-auto.com/intl/drw/9/8417011800.pdf> is stored in the parameter set in the tab *Vehicle*.

## 5.10.7 Operating data record (ODR)

### Purpose

For saving different data documenting the vehicle operation and enabling conclusions to be drawn concerning the vehicle handling.

This operating data can be evaluated using the "ODR Tracker" PC analysis tool.

The operating data recorder is split into "Historical data" (trip accumulator, histograms) and the event recorder.

The ODR data can be protected from deletion by a user-defined password. The password can be assigned using the TEBS E diagnostic software (menu *ODR, Password Management*).

### Statistical data

The statistical data is stored as sums or mean values throughout the unit's service life or starting from the last time the Operating Data Recorder (ODR) was erased.

Statistical data is:

- Operating hours
- Number of trips
- Average load
- Overload counter (trips)
- Average braking pressure
- Number of brake applications
- Number of brake applications with pressure on yellow coupling head (without CAN connection)
- Number of brake actuations in 24N operation
- Number of brake applications with anti-jackknifing brake
- Number of park brake actuations
- Odometer and operating hours since the brake linings were last replaced



- Data pertaining to air suspension system and lifting axle activation
- Number of RSS brake applications or critical lateral acceleration

## Trip accumulator

A trip has a distance of at least 5 kilometres and a minimum speed of 30 km/h. The trip accumulator stores data from the last 200 trips.

The following data is recorded per trip:

- Kilometres at start of trip
- Distance driven in kilometres
- Operating hours at start of trip
- Driving hours
- Maximum speed
- Average speed
- Average control pressure
- Brake actuations
- Braking frequency
- Aggregate load at beginning of trip
- ABS brake applications
- RSS interventions, stage 1 (test brake)
- RSS interventions, stage 2 (deceleration brake application)

If a SmartBoard is connected, the trips are provided with time and date information. Date and time can also be transferred from the towing vehicle.

---

TEBS E4

Up to 600 trips can be stored.

The average lateral acceleration in bends is also saved for each trip.

---

## Histogram

Measured values relating to braking pressures, axle loads and speeds are constantly captured during operation.

Histograms represent the frequency of events with the respective measured values. This enables one, for instance, to determine whether the driver applied the brake in a forward-thinking manner, softly or rather more sharply on the basis of the distribution of brake actions in classified braking pressure ranges.

The following histograms can be retrieved:

- **Aggregate load (sum of all axles):**  
Recording the kilometres travelled per combined multi-axle class
- **Axle load (axle load for one axle):**  
Recording the kilometres travelled per combined axle load class
- **Braking time:**  
Recording the braking time per class and the maximum occurring pressure
- **Control pressure:**  
Recording the braking requests per class and the maximum occurring pressure

- **Braking pressure:**

Recording the executed braking pressures per class

A detailed description of the histograms can be found in the ODR Tracker operating manual ▶ chapter "2 General information", page 7 => section "Technical Documents".

## Event recorder

The event recorder stores the number (a maximum of 200) of events, i.e. braking system events.

Each event is saved in the TEBS E Modulator, together with the time of occurrence (only in SmartBoard) and the odometer reading at that time.

Such events can include:

- ABS interventions
- RSS interventions
- Warning display illuminated
- Messages
- Manual deactivation of TailGUARD™
- Immobilizer events
- Events that can be defined with GIO Parameter setting (e. g. if a connected door contact switch indicates the opening of a door)
- OptiTurn™ activity (from TEBS E5)

---

TEBS E4

Up to 500 events are stored; these now also include any diagnostic messages

---

## 6 GIO functions

Functions that can be created using the GIO interfaces for the TEBS E Modulator and other components are described in this chapter. A TEBS E Modulator (Premium) is usually required for these functions ▶ chapter "4.1 System structure", page 14.

### Introduction to GIO

GIO means Generic Input/Output and designates programmable inputs and outputs.

The Trailer EBS E Modulator has 4 GIO slots in the standard version and 7 GIO slots in the Premium version.

The GIO functions enables various additional functions to be activated in the trailer modulator.

More GIO slots are made available with the electronic extension module ▶ chapter "4.1 System structure", page 14, for connecting extra components.

The standard functions are allocated (preset) with the TEBS E diagnostic software. Many are multi-use functions (e.g. integrated lifting axle control, speed switch ISS, steady positive voltage).

The parameter settings can be used to assign different functions to the GIO slots. Parameter settings can also be used to select whether, for safety reasons, outputs should be monitored for cable breaks. If a load is connected to a GIO output with no parameterised function, a fault is detected.

All GIO slots have at least one switching output (output stage) and one ground contact. The other two pins are assigned differently. That means that not all functions can be allocated equally to all slots ▶ chapter "12.2 Pin assignment", page 204. The maximum charge for all GIO switching outputs is 1.5 A.

---

**!** GIO functions are available if the system is supplied with sufficient voltage and is fault-free.

---

#### **GIO output stage**

The GIO output stage can be used to switch electrical charges (e.g. solenoid valves, lights).

They can also be used as inputs. Whether a switch has an open circuit or is switched to ground can be sensed this way. If the switch is switched to positive, a fault is detected when the switch is closed.

#### **GIO analogue input**

The GIO analogue input can be used to read in analogue signals (e.g. from the pressure sensor) or to detect signals from buttons.

#### **GIO height sensor input**

ECAS height sensors can be connected to the GIO height sensor inputs for internal level control or, in the case of mechanical suspension vehicles, for sensing the compression rebound as a means of determining the axle load.

## 6.1 Lifting axle control

 <b>WARNING</b>	<b>Risk of injury from trapped limbs when lowering the lifting axle</b> <p>The lifting axle functions are usually controlled by changing the load status. In addition, changing the height of the chassis can also affect the status of the lifting axle.</p> <p>A sudden lowering of the lifting axle can frighten or even endanger people in the immediate vicinity. This applies particularly to persons who are underneath the vehicle, to carry out repairs for example.</p> <ul style="list-style-type: none"><li>– <i>To prevent accidents, vehicle manufacturers should draw attention in their operating manual to the hazard posed by the automatic lifting axle control mechanism.</i></li><li>– <i>Lifting axles must be lowered and the ignition turned off before any repair work is carried out on the vehicle.</i></li></ul>
--	--

### Vehicle type

Trailer vehicle with one lifting axle or multiple lifting axles.

### Lifting axle control in drawbar trailer

With a 3-axle drawbar trailer, it is possible to use axle 2 or 3 as a lifting axle. If the TEBS Modulator is installed on the front axle of the vehicle, the rear axle, which remains on the ground, must be monitored with an external pressure sensor.

### Purpose

Lifting one axle of the partially laden or unladen vehicle reduces tire wear, particularly while cornering.

### Function

Control of the lifting axles via TEBS E depending on the current axle load and the current load status.

Several lifting axles of a vehicle can be controlled jointly or separately.

The vehicle speed at which it is still permitted to raise the lifting axle(s) can be set.

The sequence in which the axles are lifted can be set in the parameter settings. Parameters are set for the pressure applied for lifting and lowering the lifting axle. The 1st lifting axle is always raised first, followed by the 2nd lifting axle.

The TEBS E diagnostic software gives practicable bellows pressures for controlling the lifting axles. However, these suggestions can be adapted by the user for special vehicles (e.g. 3-axle drawbar trailer with forklift transport).

The position of the lifting axles is transmitted to the "Towing vehicle" CAN interface and can be displayed there on the instrument panel provided the required towing vehicle equipment is installed.

## TEBS E1

The bellows and supply pressure are checked as of TEBS E1. The lifting axles stop being raised by the fully automatic lifting axle mechanism if the supply pressure drops below 6.5 bar.

In the case of systems with an ECAS function, the lifting axles also stop being raised by the fully automatic lifting axle mechanism if the chassis is at buffer level.

A new plausibility check for the lifting axles is also integrated when lifting or lowering to prevent a so-called yo-yo effect. This yo-yo effect always occurs if the difference between the lifting and lowering pressures is  $< 1.0$  bar.

This pressure difference is checked by the TEBS E diagnostic software on entry and a corresponding message is displayed when entering the parameter.

If there is no ISO 7638 power supply while the towing vehicle is driving and therefore the ECU is only supplied via the 24N stop light supply, there is no lifting axle control.

The lifting axle control will only work correctly if ISO 7638 power supply is guaranteed and  $v = 0$  km/h.

**Setting the behaviour of the lifting axle when the ignition is switched off:** With a spring returned lifting axle valve (LACV), the lifting axle is always lowered when the ignition is switched off. With a pulse-controlled lifting axle valve, the lifting axle can remain in lifted position.

## TEBS E2

Up to three pulse-controlled valves can be controlled in parallel on the TEBS E Modulator.

## TEBS E5

The status of the lifting axle is not changed during a brake application.

## TEBS E5

If the vehicle height is changed by the driver when the vehicle is stationary, the raised lifting axles are lowered. The lifting axles are raised again after the ignition is turned off and on again, or after setting off, if allowed for by the load status.

WABCO recommends that this function is only used for vehicles with tag axles.

## Lifting axle valve types

**Pulse-controlled:** The valve has two solenoids that can be used, apart from charging and venting, to effect a holding position to partially relieve the lifting axle.

**Spring-returned:** The lifting axle is lowered or raised without intermediate positions. If the voltage is switched off, the lifting axle is lowered.

**Single-circuit or dual-circuit:** With the dual-circuit valves, the support bellows for the lifting axles are connected separately (by side) with the other support bellows. These valves are required for soft or split axles. Due to the stiffness of the axles typical for trailers, the simpler single-circuit lifting axle systems are now prevalent. Here the two support bellows of the lifting axle are directly connected to one another.



## Lifting axle control LA1 (lifting axle 1)

The following connecting methods are available for controlling the 1st lifting axles or two parallel controlled lifting axles: a spring-returned lifting axle control valve 464 084 0XX 0 or a pulse-controlled lifting axle valve 463 084 100 0 or a pulse controlled ECAS solenoid valve block with lifting axle control 472 905 114 0.



## Lifting axle control LA2 (lifting axle 2)

The following connecting methods are available for controlling the 2nd lifting axle: a spring-returned lifting axle valve 463 084 0XX 0 or a pulse-controlled lifting axle valve 463 084 100 0.

## Components

COMPONENT/PART NUMBER	VEHICLE TYPE	PURPOSE/FUNCTION	COMMENT	CONNECTING CABLE
Lifting axle valve (LACV) 463 084 031 0 (without threaded couplings) 463 084 041 0 (with threaded couplings) 463 084 042 0 (with threaded couplings) 463 084 050 0 (12 V variant with NPTF thread; for Multi-Voltage applications)	All trailer vehicles with lifting axle(s)	Control of up to two lifting axles, dependent on the current axle load.  Traction help with maintained residual pressure is possible (only with auxiliary solenoid valve, e.g. 472 173 226 0)	All variants: 1-circuit, spring-returned	Cable for conventional lifting axle, RTR 449 443 XXX 0
				
Lifting axle valve 463 084 010 0	All trailer vehicles with lifting axle(s)	Control of up to 2 lifting axles in a 2-circuit air suspension system dependent on the current axle load.	2-circuit, spring-returned	Cable for conventional lifting axle, RTR 449 443 XXX 0  Without DIN bayonet connection; this requires the use of adapter 894 601 135 2.
				
Lifting axle valve LACV-IC 463 084 100 0	All trailers with lifting axle(s) or tag axle	Use of a lifting axle for actuating the third axle on 3-axle semitrailers for dynamic wheelbase control (OptiTurn™ / OptiLoad™).  Traction help with maintained residual pressure is possible.	Pulse-controlled	Cable for lifting axle valve 449 445 XXX 0 or 449 761 XXX 0
				

## GIO functions

COMPONENT/PART NUMBER	VEHICLE TYPE	PURPOSE/FUNCTION	COMMENT	CONNECTING CABLE
ECAS solenoid valve 472 905 114 0 	Semitrailer/drawbar trailer (with lifting axle)	Lifting axle control in combination with ECAS 1-point control. Control of the vehicle level for one or multiple axles. Lifting/lowering of one or two parallel-controlled lifting axles. Traction help with maintained residual pressure is possible.	1 circuit, pulse-controlled	Cable for ECAS solenoid valve 449 445 XXX 0 (2x)
ECAS solenoid valve 472 905 111 0 	Semitrailer/drawbar trailer (with lifting axle)	Lifting axle control in combination with ECAS 2-point control. Control of the vehicle level for one or multiple axles. Lifting/lowering of one or two parallel-controlled lifting axles. Traction help with maintained residual pressure is possible.	2 circuit, pulse-controlled	Cable for ECAS solenoid valve 449 445 XXX 0 Cable for ECAS 2-point control 449 439 XXX 0
Tag axle valve 472 195 066 0 	Trailer vehicles with TEBS E Multi-Voltage from version TEBS E4	Pressurising and venting of the support bellows for a tag axle, e.g. for OptiTurn™.	A pressure sensor is required on the tag axle to maintain residual pressure.	Cable for tag axle valve 449 445 XXX 0

## WABCO recommendation when selecting valves for lifting axles

	LIFTING AXLE VALVE, SPRING-RETURNED 463 084 010 0 463 084 031 0 463 084 04X 0	LIFTING AXLE VALVE, PULSE-CONTROLLED 463 084 100 0	ECAS SOLENOID VALVE, PULSE-CONTROLLED 472 905 114 0 472 905 111 0
	IN COMBINATION WITH TEBS E MODULATOR 480 102 03X 0 (STANDARD)	IN COMBINATION WITH TEBS E MODULATOR 480 102 06X 0 (PREMIUM)	
<b>Behaviour of the lifting axle with the ignition switched off</b>			
Lifting axle remains in the desired and defined position (lifted or lowered).	✗	✓	✓
Lifting axle lowers.	✓	✗	✗
<b>Lifting axle control, traction help, forced lowering, OptiTurn™ / OptiLoad™</b>			
One lifting axle without dynamic wheelbase control.	✓	✓	✓
Two lifting axles without dynamic wheelbase control. Recommendation by the axle manufacturer: With two lifting axles, one lifting axle should be dual-circuit.	✓	✓	✓
One lifting axle or tag axle with dynamic wheelbase control on axle 3 for axle load distribution under load or automatic lifting when driving in a circle.	✗	✓	✓

### Operation

Information on operation ▶ chapter "10.6 Operating the lifting axles", page 192.

### Parameter setting

The vehicle configuration is defined in the TEBS E diagnostic software in *tab 2, Vehicle*.

The lifting axle valves and switching pressures are defined in *tab 5, Lifting Axle Control*.

Which GIO slots are to be used is defined in *tab 11, Connectors*.



## 6.2 Tag axle control with maintained residual pressure

### Vehicle type

Semitrailer with tag axles / trailing steering axles.

Semitrailer with tag axles and OptiTurn™ / OptiLoad™ function ▶ chapter "6.7 Dynamic wheelbase control", page 86.

### Purpose

When using tag axles, the bellows should not be completely vented as otherwise parts of the air bellows will rub against one another (wrinkling the bellows) and cause damage.

The integrated function helps avoid tire damage, increased tire wear and possible damage to the bellows by maintaining the residual pressure in the support bellows.

### Installation

With tag axles, the wheel speed must be sensed and the braking controlled via a separate modulator.

WABCO recommendation: Brake the tag axle using an EBS relay valve (4S/3M system).

An external axle load sensor e-f must also be installed to measure the bellows pressures on the tag axle.

To control the tag axle, a pulse controlled lifting axle valve (LACV-IC) must also be used.

---

**!** It is not possible to use spring-returned lifting axle valves.

---

### Parameter setting

One axle must be defined as a tag axle in the TEBS E diagnostic software in *tab 2, Vehicle*.

The residual tag axle pressure is then defined in *tab 5, Lifting axle control*. The residual pressure can be set as a value greater than 0.3 bar.

## 6.3 Integrated electronically controlled air suspension system (ECAS)

### Vehicle type

All trailer vehicles with air suspension.

Two control circuits can be realised:

- 1-point control
- 2-point control (with version TEBS E2 or higher)

### System designs

- Semitrailer, central axle trailer:  
1-point control or 2-point control as side control in vehicles with independent wheel suspension.
- Drawbar trailer:  
2-point control for front and rear axle.

### Purpose

The basic function of the ECAS is to compensate for level changes which occur, for example, due to a change in the load status or newly defined nominal values (e.g. from the remote control unit). These control deviations change the distance between the vehicle's axle and its superstructure. ECAS balances these control deviations by means of level control.

The essential benefit of ECAS lies in the reduced air consumption and faster control when stationary. While a levelling valve only controls the normal level, ECAS can keep every level constant.

### Function

A height sensor is mounted on the vehicle body and is connected to its axle via a lever system. The height sensor picks up the distance between the axle and the vehicle body. The intervals depend on the vehicle's operating condition (driving or loading operation).

This measured value is used as the actual value in the control loop and is sent to the ECU. The ECU compares this actual value to the nominal value predefined in the ECU.

In the event of a difference between the actual value and the nominal value (control deviation), the ECAS solenoid valve receives an actuating signal. Depending upon this actuating signal, the ECAS solenoid valve now aerates or vents the support bellow. The change in pressure in the support bellow alters the distance between the axle and the vehicle body. The new distance is also picked up by the height sensor, and the cycle begins again.

---

! In the case of vehicles that could have differing lateral pressures while they are being driven, it must be ensured that the higher bellows pressure is always used to control the braking force, because otherwise the vehicle may not attain the required braking deceleration. This is achieved by connecting the bellow pressures on both sides of the vehicle to the TEBS E Modulator via a Select High valve.

A better solution, however, is to determine the mean value with the aid of a second axle load sensor ▶ chapter "5.9.2 Load Sensing Valve (LSV)", page 40.





---

# GIO functions



## Components

COMPONENT / PART NUMBER	VEHICLE TYPE	PURPOSE/ FUNCTION	COMMENT	CONNECTING CABLE
TEBS E Modulator 480 102 06X 0 	All trailer vehicles with air suspension	Control and monitoring of the electronic air suspension	TEBS E Modulator (Premium) with PEM	
Electronic extension module 446 122 070 0 	All trailer vehicles with air suspension	2-point control (with version <b>TEBS E2 or higher</b> )	<b>Not required for 2-point control with TEBS E4 or higher.</b> In combination with TEBS E Modulator (Premium)	Cable to TEBS E 449 303 XXX 0
eTASC 463 090 5XX 0 	All trailer vehicles with air suspension	ECAS valve with manual actuation for lifting and lowering	Only possible in combination with <b>TEBS E Modulator (Premium) from version TEBS E3</b> and with height sensor.	Cable for ECAS solenoid valve 449 445 XXX 0
ECAS solenoid valve 472 880 030 0 Multi-Voltage 472 880 072 0 	Semitrailer / central axle trailer (without lifting axle)	1-point control Control of the ride height on one or multiple axles on parallel circuits (lifting/lowering)	The support bellows on the vehicle sides are connected via a cross flow throttle.	Cable for ECAS solenoid valve 449 445 XXX 0
ECAS solenoid valve 472 880 020 0 (front axle) 472 880 030 0 (rear axle) 	Drawbar trailer (without lifting axle) Front axle and rear axle	2-point control (lifting/lowering on two axles)	2-point control (with <b>version TEBS E2 or higher</b> ) The support bellows on the vehicle sides are connected via a cross flow throttle.	2x cable for ECAS solenoid valve 449 445 XXX 0

# GIO functions

COMPONENT / PART NUMBER	VEHICLE TYPE	PURPOSE/ FUNCTION	COMMENT	CONNECTING CABLE
ECAS solenoid valve 472 880 001 0 472 880 070 0 (Multi-Voltage) 	Semitrailer / central axle trailer (support bellows of the axle(s) are not connected to one another) (without lifting axle) Drawbar trailer (support bellows of the axles are respectively connected to one another)	2-point control of the vehicle sides or control of the front and rear axle of a drawbar trailer	2-point control ( <b>with version TEBS E2 or higher</b> )	Cable for ECAS 2-point control 449 439 XXX 0
ECAS solenoid valve 472 905 114 0 	Semitrailer / central axle trailer with lifting axle / rear axle Drawbar trailer with lifting axle	1-point control Control of the ride height on one or multiple axles on parallel circuits (lifting / lowering)	Pulse-controlled lifting axle The front axle of a drawbar trailer can be additionally controlled using valve 472 880 030 0.	Cable for ECAS solenoid valve 449 445 XXX 0
ECAS solenoid valve 472 905 111 0 	Semitrailer / central axle trailer with lifting axle (support bellows of the axle(s) are not connected to one another) / rear axle drawbar trailer (without lifting axle) Drawbar trailer with lifting axle (support bellows of the axles are respectively connected to one another)	2-point control Control of the ride height on one or multiple axles on parallel circuits (lifting / lowering)	2-point control ( <b>with version TEBS E2 or higher</b> ) Pulse-controlled lifting axle	Cable for ECAS solenoid valve 449 445 XXX 0 Cable for ECAS 2-point control 449 439 XXX 0
Height sensor 441 050 100 0 	Semitrailer / drawbar trailer with air suspension	Measuring the normal level	Only use the WABCO height sensor 441 050 100 0.	Cable for height sensor 449 811 XXX 0
Lever 441 050 718 2 441 050 641 2 	All trailer vehicles with air suspension	Extension for height sensor lever	Attachment to the height sensor	

# GIO functions

COMPONENT / PART NUMBER	VEHICLE TYPE	PURPOSE/ FUNCTION	COMMENT	CONNECTING CABLE
<p>Linkage 433 401 003 0</p> 	All trailer vehicles with air suspension	Connection to the axle		
<p>ECAS control box 446 156 02X 0</p> 	<p>446 156 021 0 Semitrailer without lifting axle</p> <p>446 156 022 0 Semitrailer with lifting axle</p> <p>446 156 023 0 Drawbar trailer</p>	Control unit (with 6 buttons) for adjustment of the level and the lifting axle control by the driver.	Installed on the side of the trailer.	Cable for ECAS control box 449 627 XXX 0
<p>ECAS remote control unit 446 056 117 0</p> 	Semitrailer / drawbar trailer	Control unit (with 9 buttons) for adjustment of the level and the lifting axle control by the driver. Normally installed on the side of the trailer.	Control unit and cable connection must be protected against moisture.	Cable for ECAS remote control unit 449 628 XXX 0
<p>ECAS remote control unit 446 056 25X 0</p> 	Semitrailer / drawbar trailer	Control unit (with 12 buttons) for adjustment of the level and the lifting axle control by the driver.	Control unit and cable connection must be protected against moisture. Normally installed on the side of the trailer.	
<p>SmartBoard 446 192 11X 0</p> 	Semitrailer / drawbar trailer	Display and operating panel for adjustment of the level and the lifting axle control by the driver. Normally installed on the side of the trailer.	<p>446 192 110 0 (with integrated battery)</p> <p>446 192 111 0 (for hazardous goods vehicles)</p> <p>Spare battery 446 192 920 2</p>	<p>Connection to TEBS E 449 911 XXX 0</p> <p>Connection to electronic extension module 449 906 XXX 0</p>
<p>Trailer Remote Control 446 122 080 0</p> 	<p>Application in the towing vehicle for controlling trailer vehicles</p> <p>All towing vehicles</p>	Display and operating panel for adjustment of the level and lifting axle control by the driver (from the driver's cab)	Can only be used in combination with the electronic extension module and <b>from version TEBS E2 Premium</b> .	<p>Scope of delivery:</p> <ul style="list-style-type: none"> <li>■ Connection cable between the Trailer Remote Control and the fuse box in the truck</li> <li>■ Mounting bracket</li> </ul>

## eTASC

eTASC combines the solenoid valve functions of an electronically controlled air suspension (ECAS) and the lever operation of a conventional air suspension system with rotary slide valve (combination of TASC and ECAS solenoid valve).

The full range of electronic air suspension functions (ECAS) is available in the operational state "Power Supply On".

The front and rear axles of drawbar trailers are controlled by means of two eTASC devices. Lateral control of a semitrailer with two eTASC devices is not permitted.

### Lifting

The bellows are pressurised and the body of the vehicle is raised by turning the lever anti-clockwise.

### Lowering

The bellows are depressurised and the body of the vehicle is lowered by turning the lever clockwise.

### RSD (Rotary Slide Detection)

The lever automatically returns to the "Stop" position when it is released. Trailer EBS E now recognises the current level as the nominal level. The level is adjusted to this nominal level until the next operator intervention, the next time the ignition is switched off, or until the vehicle starts driving again. This level (return-to-load) is controlled by ECAS.

**Device variant "Dead-man's safety system":** The lever automatically returns to the "Stop" position when it is released. Trailer EBS E recognises the current level as the nominal level. The level is adjusted to this nominal level until the next operator intervention, the next time the ignition is switched off, or until the vehicle starts driving again.

**Device variant "Lock on lowering":** The lever remains in the "Lowering" position when it is released. The vehicle is lowered to the buffers. As long as the operator does not take further action, the lever will only automatically return to "Stop" when the vehicle moves off and its normal level is controlled by Trailer EBS E (RtR function).

**Device variant "Lock on lifting":** The lever remains in the "Raise" position when it is released. The vehicle is raised up to the calibrated maximum height. Without a power supply, the vehicle is raised by the height limiting valve up to the arrester cable or the end stop. When the vehicle moves off, the lever automatically returns to "Stop" and the vehicle's normal level is controlled by Trailer EBS E (RtR function).

**Behaviour with ignition off / vehicle uncoupled:** The vehicle is operated in the same manner as with the ignition turned on. The level that is reached will not be identified as the nominal level, however, and no further adjustments, such as loading or unloading, are made.

---

! The RtR function is only available when the vehicle is supplied with power via ISO 7638. If power is being supplied via the stop light (24N), RtR is not applied until the first braking action after the RtR speed has been exceeded provided that the duration over which the brake is applied, or the duration of the TEBS E power supply, is sufficient to control the height.

---

---

! Manual lifting, stopping and lowering is possible in all operational states. This allows for rapid height adjustment, for example when the vehicle is being driven.

---

## **System is being supplied with power**

The operational state "Power supply on" describes the trailer vehicle being supplied with power. This state can be implemented in three different ways:

- The towing vehicle and trailer vehicle are connected by means of the ISO 7638 power supply and the ISO 1185 stop light supply, and the ignition is turned on.
- ISO 7638 and ISO 1185 are connected, the ignition is turned off, and stand-by operation is activated.
- The trailer is supplied with power by its own battery.

The electronic air suspension controls the vehicle height while driving and when stationary. In contrast to conventional air suspension, the level is also adjusted when set manually with the rotary lever when stationary, at a loading ramp for example. The manual return to normal level by means of the normal level switch or SmartBoard is available, as are the memory levels and the automatic height limit.

## **System is not being supplied with power**

The operational state "Power supply off" characterises a trailer vehicle without power. Here, the trailer can be uncoupled from the towing vehicle, or the ISO 7638 connection to the towing vehicle is present, but the towing vehicle switches off terminal 15 as well as 30 when the ignition is switched off. In this operational state, the body height can be changed manually using the control lever. The electronic air suspension functions are not active in this case. The level changes resulting from loading and unloading are not adjusted by the system but can be adjusted manually by operating the lever as required. In this case compressed air is supplied from the reservoir. The height limit can only be implemented here with an optional auxiliary valve.

## **Stop light supply**

The operational status "Stop light supply 24N" describes a trailer that is exclusively connected to the towing vehicle via ISO 1185 or ISO 12098. When stationary, the vehicle body can be lifted and lowered manually using the control lever. When driving, the body level is adjusted automatically with each brake action. The RtR function is also activated. Several braking applications may be required to attain the normal level.

## **Return to load**

If OptiLevel was set to a programmed level, it keeps the trailer vehicle on this level. If it is being supplied with electrical power, OptiLevel immediately compensates changes in the load status and the constant movement of forklift trucks when loading and unloading.



## eTASC variants (2-circuit)

VARIANT	CONNECTIONS 1, 2.2, 2.4	TEST CONNECTION	LOCK ON LIFTING	LOCK ON LOWERING
463 090 500 0	∅ 12x1.5	✓	✗	✓
463 090 501 0	∅ 8x1.5	✓	✗	✓
463 090 502 0	M 16x1.5	✓	✗	✓
463 090 503 0	M 16x1.5	✓	✓	✓
463 090 504 0	∅ 8x1.5 ∅ 12x1.5	✓	✗	✓
463 090 510 0	M 16x1.5	✗	✗	✗

### Height limitation

With eTASC, the vehicle can be lowered or lifted even when the ignition is turned off. In this case the height is not monitored so that the ECAS height limitation does not intervene.

Vehicles that have to be prevented from exceeding a maximum height require arrester cables or a pneumatic height limiting valve 964 001 002 0. This interrupts the connection between eTASC and the supply reservoir upon reaching a height that is set mechanically.

### Installing eTASC

Information on installation ▶ chapter "8.10 Installing eTASC", page 172.

### Parameter setting

The parameters are set in the TEBS E diagnostic software in *tab 7, Air Suspension*.

### System response with ignition "On"

<b>Parameter setting</b>	<input type="checkbox"/> No level control at a standstill <input checked="" type="checkbox"/> Manual lifting/lowering (eTASC)	<input type="checkbox"/> No level control at a standstill <input type="checkbox"/> Manual lifting/lowering (eTASC)	<input checked="" type="checkbox"/> No level control at a standstill <input checked="" type="checkbox"/> Manual lifting/lowering (eTASC)	<input checked="" type="checkbox"/> No level control at a standstill <input type="checkbox"/> Manual lifting/lowering (eTASC)
<b>Operation using eTASC</b>	<input checked="" type="checkbox"/> RSD <input checked="" type="checkbox"/> Return to load	<input checked="" type="checkbox"/> Not available <input checked="" type="checkbox"/> No RSD <input checked="" type="checkbox"/> No Return to Load	<input checked="" type="checkbox"/> RSD without Return to Load	<input checked="" type="checkbox"/> Not available <input checked="" type="checkbox"/> No RSD <input checked="" type="checkbox"/> No Return to Load
<b>Operation using SmartBoard or electronic control</b>	<input checked="" type="checkbox"/> Full ECAS functionality ▶ page 66	<input checked="" type="checkbox"/> Full ECAS functionality ▶ page 66	<input checked="" type="checkbox"/> Full ECAS functionality ▶ page 66	<input checked="" type="checkbox"/> ECAS without Return to Load

### Height sensors

With 2-point control using TEBS E and the electronic extension module, the following options are available for installing the height sensors and setting their parameters:



- One distance sensor is connected to TEBS E, and a second distance sensor is connected to the electronic extension module.
- Both distance sensors are connected to the electronic extension module.
- Both distance sensors are connected to TEBS E (**from TEBS E4**).

## Parameter setting

The distance sensors are assigned when setting the parameters in the TEBS E diagnostic software in *tab 11, Connectors, TEBS E & Electronic Extension Module*.

## Installation

Information on installing the height sensors ▶ chapter "8.6 Installing the height sensor", page 158.

## Operation

Information on operation ▶ chapter "10 Operation", page 181.

### 6.3.1 Nominal level control

#### Nominal level

The nominal level is the nominal value for the distance between the vehicle's body and axle. This nominal level is defined by calibrating it, setting its parameters, or by the driver (e.g. using SmartBoard).

#### Function

A modulator acting as a solenoid valve is actuated, aerating and venting the support bellow to bring the actual level into line with the nominal level.

This occurs when

- control deviations exceed a tolerance range (e.g. due to changes in weight),
- the defined value for the nominal level is changed (e.g. by selecting a memory level).

Unlike conventional air suspension systems, ECAS controls not only the normal level, but also any other predefined level. Therefore a level which is set for loading or unloading processes is assumed to be the nominal level.

In other words: If the load status changes, the vehicle remains at the set level, whereas in vehicles with conventional air suspension this level must be adjusted manually, or the vehicle body is lowered during loading and raised during unloading.

If the power supply is interrupted or the air supply is insufficient, e.g. when the ignition is switched off, the nominal level is no longer controlled.

By using the speed signal, the electronic level control system differentiates between static and dynamic changes in the wheel load, unlike conventional air suspension systems. A level change is only adjusted with a delay while driving. Otherwise, readjusting the vehicle would waste compressed air in certain conditions, for example when the suspension is compressed on roads with potholes.

	STATIC WHEEL LOAD CHANGES	DYNAMIC WHEEL LOAD CHANGE
Application	<ul style="list-style-type: none"> <li>■ When the load status changes</li> <li>■ When stationary</li> <li>■ At low vehicle speeds</li> </ul>	<ul style="list-style-type: none"> <li>■ Dynamic wheel load changes are caused by bumpy and uneven road surfaces at higher speeds.</li> <li>■ The wheel load changes when driving uphill or downhill, which affects the control performance.</li> </ul>
Control functions	<p>Check the actual value and correct it as required by aerating or venting the respective air suspension bellows at short intervals (e.g. 1x per second) with the electronic level control, <i>Extended ECAS parameters, control delay</i>.</p>	<p>Dynamic wheel load changes are usually compensated by the suspension behaviour of the support bellows. In this case, aerating or venting the bellows would not be desirable because only the isolated bellow has a practically constant suspension characteristic.</p> <p>When the excess air is vented from the bellows during the rebound action, it must be replaced again during compression, which ultimately increases the strain on the compressor and the fuel consumption. For this reason, the regulation is checked at considerably longer intervals when the vehicle is moving at higher speed (usually every 60 seconds). The actual value is continuously compared against the nominal value.</p>
Comment		<p>Because not every road unevenness is compensated (e.g. when driving on roads in poor condition), less air is consumed by the electronic air suspension than by conventional level control systems with levelling valves.</p>

## ECAS stand-by time

ECAS only operates properly when the ignition is switched on. A parameter can be set for an ECU stand-by time after the ignition is switched off to define how long the ECAS stays in stand-by mode.

**!** This function is executed by the power supply at terminal 30. Not all towing vehicles allow this function because they switch off terminals 15 and 30 in parallel.

**TEBS E5**

### Nominal value control after ignition off

This applies to the lowering of a raised lifting axle when the ignition is switched off. The resultant change in height of the chassis from lowering the lifting axle is compensated.

## 6.3.2 Driving levels

### Driving level I (normal level)

Driving level I (normal level) refers to the nominal level defined by the vehicle manufacturer for driving under optimal conditions (optimum body height).

Driving level I is defined by the overall vehicle height, which is bound by legal guidelines, as well as the height of the vehicle's centre of gravity, which plays a crucial role in driving dynamics.

The normal level is the designated basic design parameter for the vehicle.

### Driving level II

Driving level II is defined as the difference to driving level I (normal level). If driving level II is lower than driving level I, this value must be entered as a negative value in the TEBS E diagnostic software.

#### Application

- If the semitrailer is being operated behind different towing vehicles (with different fifth-wheel heights), the body can be positioned horizontally.

### Driving III

Driving level III is a driving level like driving level II except that it corresponds to the maximum body height and is therefore the highest driving level.

---

**TEBS E2** Driving level III could only previously be selected with the speed. As of TEBS E2, it can now be selected using the ECAS remote control unit as well.

---

#### Application

- Used for adjusting the trailer to various platform heights.
- For fuel saving (e.g. at higher speed).
- For lowering the vehicle centre of gravity to achieve more lateral stability.

Lowering the superstructure depending on the vehicle's speed is based on the assumption that higher speeds are achieved on good road surfaces which do not require the whole of the bellows' spring stroke to be utilised.

### Driving level IV

---

**TEBS E2** Whether the unloading level function or an extra driving level IV is to be used can be selected in the parameter settings.

---

### Unloading level

The unloading level is only actuated when stationary or at low speed for easier unloading of the vehicle. When the speed is achieved, the last saved level is readjusted automatically.

## Application

- To lower a dumper to prevent hard rebounds due to a sudden discharge (dumping the load).
- To automatically move road tankers to the best unloading position.
- To improve stability.

## Unloading level switch

Example: If the switch is attached to a tipping body, the vehicle will then lower automatically to a defined level as soon as the body is tipped. Ideally this value corresponds to the buffer or lower calibration level. This avoids overloading the axle combination during sudden unloading.

This function is automatically deactivated  $v > 10$  km/h.

If the parameterised unloading level lies outside the parameterised lower or upper level, the stroke is restricted to this level.

An unloading level is only realised between the upper and lower calibration level even if the parameter settings specify a value outside this range.

The automatic function can be permanently deactivated in the SmartBoard.

The unloading level can be temporarily switched off using the SmartBoard, e.g. when driving in front of road finishers.

TEBS E1

### Parameter for unloading level

There are 2 parameters for the unloading level in the TEBS E diagnostic software.

- Lowering the body to the buffer
- Lowering the body to the lowest calibrated level

The TEBS E diagnostic software now features a speed-dependent parameter for the unloading level. This means that the unloading level as well as driving level IV (normal level IV) can be used. It is also possible to use switch inputs for driving level I, driving level II or driving level IV independently of one another.

## Memory level

Unlike the unloading level, which is defined in the ECU, the memory level can be defined and changed by the driver at any time. Once defined, the system will store any memory level until it is changed by the user, i.e. even when the ignition has been switched off. The memory level applies to the entire vehicle.

Two different memory levels can be used for each system.

## Application

- Recurring loading operations at a ramp with a height that has been defined once.

An ECAS remote control unit or the SmartBoard is required to call up the memory function.

- ! More information on the operating capabilities for levels ▶ chapter "10 Operation", page 181.

## 6.3.3 Green warning lamp

### Vehicle type

All trailer vehicles with ECAS.

### Purpose

Indication of ECAS faults (lamp flashes).

Indication if the trailer is outside the normal level (lamp is permanently on).

### Function

If the lamp is on permanently, there is a discrepancy between the currently selected normal level and the physical ride height of the vehicle. The level can be changed using the SmartBoard, the ECAS control box/control unit, the Trailer Remote Control or the Lifting / Lowering buttons.

- Move the vehicle back to normal level if necessary. The selected normal level is the reference level.
- Move the vehicle at a faster speed than the parameterised RtR speed.
  - ⇒ The vehicle is then automatically moved to the selected driving level.

If the lamp flashes, there is an ECAS-related fault.

- Read out the diagnostic memory using the TEBS E diagnostic software and rectify the fault.

### Parameter setting

The use of a warning lamp can be activated and parameterised in the TEBS E diagnostic software in *tab 7, Air Suspension, extended ECAS Parameters*.

- Activate the function by clicking *Warning lamp installed*. For an LED, click the parameter *As LED* (no cable break detection).
- Set the *Behaviour upon faults* parameter to define whether a fault should only be indicated after the ignition is switched on or permanently by the warning lamp.

### Connecting the components

Extract from schematic diagram 841 802 236 0

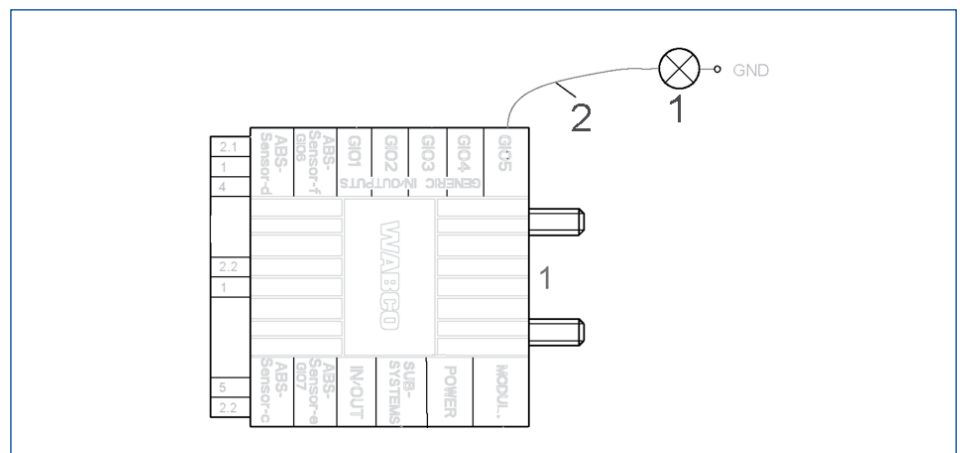

ITEM	PART NUMBER	FIGURE	DESCRIPTION
1	446 105 523 2		Green warning lamp <ul style="list-style-type: none"> <li>■ LED or bulb</li> <li>■ Mounted on the trailer vehicle in the driver's field of vision (above the rear-view mirror)</li> </ul>
2	449 535 XXX 0		Universal cable <ul style="list-style-type: none"> <li>■ 4-pin, open</li> </ul>
	449 900 100 0		Cable for green warning lamp (Superseal / open-ended)

## 6.3.4 Temporary deactivation of the automatic level control

### Vehicle type

All trailer vehicles with ECAS (integrated in TEBS E).

### Purpose

Temporary deactivation of the automatic level control while stationary, for example to reduce air consumption on the ramp during loading and unloading.

### Function

The level control is deactivated when stationary with a switch or the SmartBoard.

The menu is only visible in the SmartBoard if the function *Level control circuit breaker* is activated or eTASC is parameterised.

The readjustment is interrupted when stationary by actuating the switch or with the "Level control off" menu item in the SmartBoard.

**!** This function is also used to terminate all lifting axle functions, such as the fully automatic lifting axle control, traction help, OptiTurn™, etc. All the lifting axles are lowered.

After the ignition has been reset or as soon as the vehicle is being driven again at a speed of > 5 km/h, the automatic level control (+ including all the lifting axle functions) is activated again.

### Connecting the components

The following components can be used for operation:

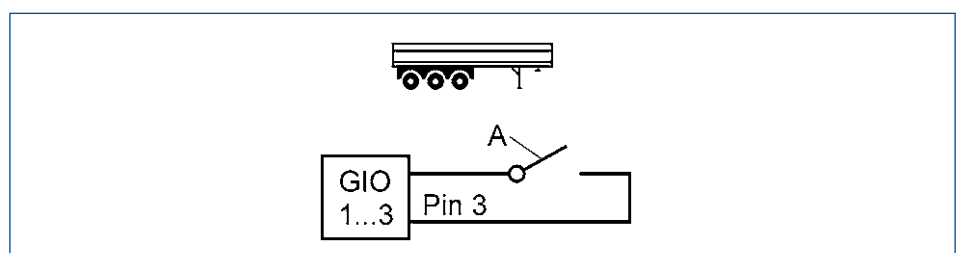

ITEM	PART NUMBER	FIGURE	DESCRIPTION
A	Not part of WABCO's scope of supply		Switch
	446 192 11X 0		Alternative: SmartBoard ■ Cable for SmartBoard 449 911 XXX 0
	449 535 XXX 0		Universal cable ■ 4-pin, open

## Parameter setting

The ECAS is activated and the components are assigned in the TEBS E diagnostic software in *tab 2, Vehicle*, and *tab 7, Air Suspension*.

Other settings can be configured in *tab 7, Air Suspension, extended ECAS parameters*.

Which GIO slots are to be used is defined in *tab 11, Connectors*.

## 6.4 Speed switch (ISS 1 and ISS 2) and RtR

### Vehicle type

All trailers.

### Purpose

The two integrated speed switches ISS 1 and ISS 2 can be used to control two functions in the trailer independently of one another.

The RtR (Return to Ride) application is used to automatically move the vehicle with air suspension to ride height after it sets off.

### Function

The switching state of the output changes when the vehicle speed exceeds or drops below a limit speed set in the parameters. This allows solenoid valves to be switched on or off depending on the speed.

A typical example of application is the simple locking of steering axles ▶ chapter "6.23 Steering axle lock", page 119. The two speed limits at which the switching condition of the output changes can be set in the parameters at anywhere between 0 and 120 km/h. A minimum switching hysteresis of 2 km/h must be observed.

The gate output is switched off below the threshold speed set in the parameters. When the threshold is reached, the output is switched on and a supply voltage is applied. Parameters can also be used to invert the switching function so that supply voltage is applied in free position.

In the event of a fault it must be ensured that the appliance controlled by the switch output does not remain in a state that will impair driving safety.



# GIO functions

In the event of a power supply failure, for instance, a steering axle should be locked as this represents a safe state.

## Connecting the components

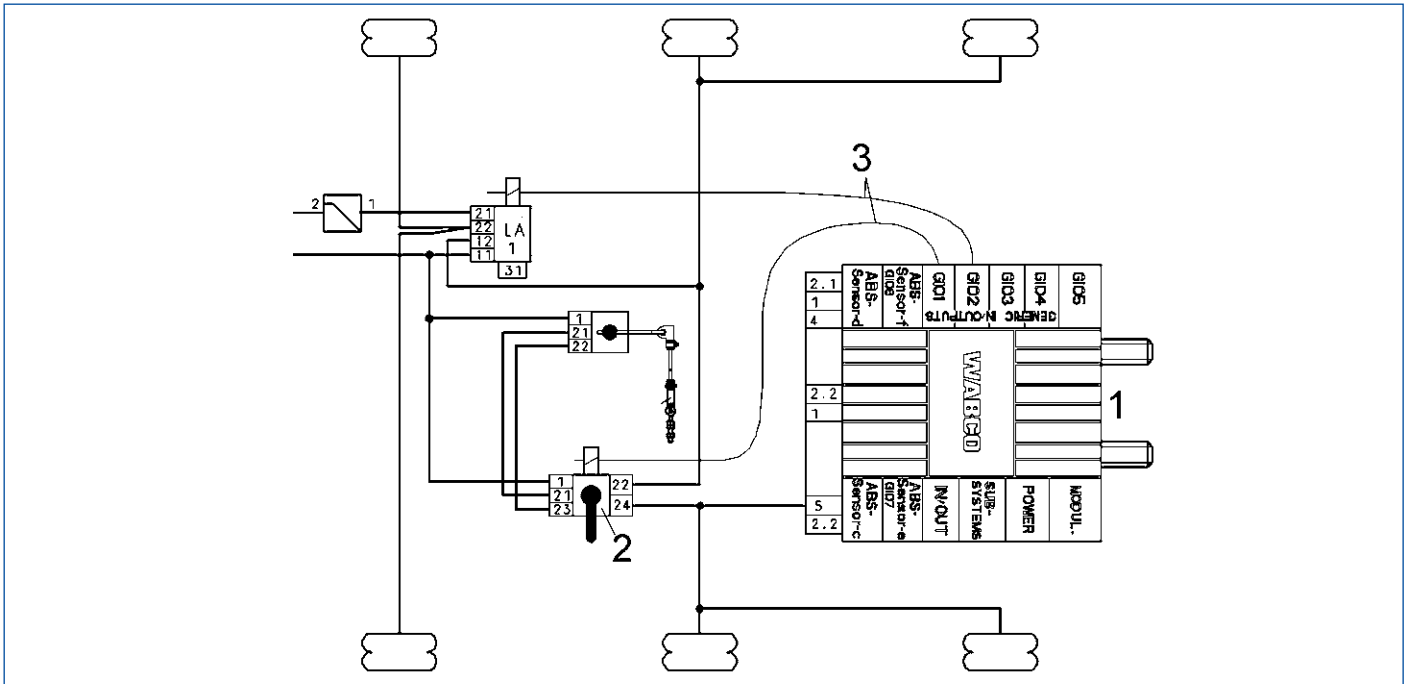
Extract from schematic diagram 841 802 150 0



ITEM	PART NUMBER	FIGURE	DESCRIPTION
1	480 102 0XX 0		TEBS E Modulator ■ Premium/Standard
2	463 090 012 0 (1-circuit; RtR, Resting in lowered position) 463 090 020 0 (2-circuit; RtR, Resting in lowered position, with screw joints and test connection) 463 090 021 0 (2-circuit; RtR, Resting in lowered position, with screw joints and test connection) 463 090 023 0 (2-circuit; RtR, Resting in lowered position) 463 090 123 0 (2-circuit; RtR, dead man's control for stroke > 300 mm)		TASC ■ A detailed description of the device can be found in the document "TASC Trailer Air Suspension Control – Function and Installation" ▶ chapter "2 General information", page 7 => section "Technical documents".
3	449 443 XXX 0		Conventional cable for lifting axle, RtR

## Parameter setting

The setting is configured in *tab 4, Standard Functions*.

Which GIO slots are to be used is defined in *tab 11, Connectors*.



## 6.5 Traction help

### Vehicle type

All air suspension trailer vehicles with a lifting axle or tag axle as the first axle.

### Purpose

On slippery ground or on steep hills, road trains find it difficult to pull away or cannot do so at all. The drive axle of the towing vehicle does not have enough traction and the wheels spin.

### Function

With the traction help, the first axle on the semitrailer is raised or the pressure is relieved. The resultant weight shift on the fifth wheel coupling increases the traction of the drive axle on the towing vehicle.

The effect of the traction help depends on the load status. The support bellow pressure monitors the load on the trailer's main axle.

The lifting or tag axle is no longer relieved once a 30 % overload is attained. The traction help is started either by the driver or automatically.

When a speed of 30 km/h is attained, the axle is lowered again or returns to automatic mode.

---

**!** Note the axle manufacturer's information about the traction help. The specifications may restrict the maximum limits of EC Directive 98/12/EC.

---

### Valve configurations

The following variants can be selected:

- **A spring-returned lifting axle valve (not suitable for all vehicles):**  
The lifting axle can be raised as a traction help providing this does not exceed the bellows pressure set in the parameters. If the permitted pressure is exceeded when the traction help is active, the function is terminated and the relevant lifting axle is lowered.  
In countries where axle loads of 3 x 9 t are permitted, traction help is cancelled as soon as the load on the axles that remain in the ground exceeds 23.4 t. The effectiveness of the traction help is therefore coupled to the load status.
- **One lifting axle valve (spring-returned) and one solenoid valve for pressure limitation (maintained residual pressure):**  
The lifting axle stops acting as a traction help until the bellows pressure set in the parameters is attained. The support bellow of the lifting axle is then shut off by the solenoid valve. The lifting axle is thereby relieved for best possible traction when starting up without exceeding the 30 % overload (the value set in the parameters) at the other axles. (The lifting axle remains relieved at 130 % axle load on the main axle and is only lowered again at 30 km/h.) This configuration allows the traction help to be used even when the vehicle is overloaded.
- **A pulse-controlled lifting axle valve:**  
The lifting axle stops acting as a traction help until the bellows pressure set in the parameters is attained. The support and lifting bellows on the lifting axle are then shut off. This means that the lifting axle can also be relieved to prevent the permitted 30 % overload from being exceeded. (The lifting axle remains relieved at 130 % axle load on the main axle and is only lowered

again at 30 km/h.) This arrangement is practicable in countries where an axle load of 9 t is permitted.

## TEBS E4

A traction help without lifting the lifting axle can also be implemented using a simple 12 V ABS tag axle valve in conjunction with the TEBS E4 Multi-Voltage.

## Activating the traction help

- **ISO 7638:** Actuation via the "Towing vehicle" CAN port from the towing vehicle.
- **SmartBoard:** Activation via the control menu of the SmartBoard.
- **Control box:** It is only possible to start the traction help if the lifting axles are resting on the ground as actuated by the fully automated lifting axle function (started by pressing the "Raise lifting axle" button).
- **Control unit:** Activated with the "Lifting Axle Preselection" and M1 buttons.
- **Trailer Remote Control:** Activated with the "Traction help" button ▶ chapter "10.2 Operation with the Trailer Remote Control", page 181.
- **Brake actuation:** When this parameter is enabled, the traction help can be activated or deactivated by applying the brake 3 times when the vehicle is stationary (the pressure must drop below 0.4 bar between the three brake applications). The following condition applies here: Vehicle is stationary. The brake must be actuated and released three times in 10 seconds with a pressure between 3 and 8 bar after a period of 2 seconds without braking pressure. The axle is forcibly lowered by applying the brake 3 more times.
- **Automatic with ignition on:** Activation of the traction help with the ignition on. This is used to automatically increase the support load with central axle trailers or provide more traction in winter conditions.
- **Automatic with curve detection:** Traction is increased during slow cornering.
- **By engaging the reverse gear**
- **Seasonal traction help (from TEBS E5):** The traction help is permanently available between the calendar start and end dates set in the parameters for the Trailer EBS Modulator. This means that during the winter months the driver does not need to repeatedly activate the traction help every time he starts the vehicle. The date can also be made available using a battery-powered SmartBoard manufactured after week 40/2015. This function can also be disabled on the SmartBoard so that the traction help is only started, for example, when it is activated by the driver during a period of mild weather. Outside of the seasonal period for the traction help, it can be started using one of the activation options mentioned above.
- **Seasonal traction help with switch (from TEBS E5):** The traction help can be permanently made available with an on/off switch installed on the trailer. When the switch is closed, the traction help is active every time the vehicle pulls away. If the switch is open, the traction help can be started using one of the activation options mentioned above.

! Further operating information ▶ chapter "10.4 Operating the traction help", page 191 and ▶ chapter "10.2 Operation with the Trailer Remote Control", page 181.

TEBS E1

## Traction help

The traction help function is supported by lifting axles on the first axle of semitrailers or central axle trailers, i.e. the lifting axle is raised on request.

**Activation:** Press the button once (for less than 5 seconds).

## "Northern" traction help

Time-based controlling of the traction help is also possible (in 1 second increments, max. 1,200 seconds).

With the lifting axle valve 463 084 0X0 0, the lifting axle is automatically lowered 5 seconds after 130% of the axle load is exceeded.

**Activation:** Press the button once (for less than 5 seconds).

## "Off-road" traction help (can only be started with the button)

This function has been developed to briefly allow higher pressures (thresholds) to be used for the traction help on private thoroughfares.

**Activation:** Briefly press the button twice.

TEBS E2

Automatic activation with the parameter *Traction help automatically with curve detection (tab 5, Lifting axle control)* in the TEBS E diagnostic software.

TEBS E2.5

The traction help is disabled and forced lowering activated by actuating the brakes another 3 times.

The traction help can also be activated in the TEBS E diagnostic software with the parameter *Traction help when ignition on (tab 5, lifting axle control)*. The function is automatically switched off when the deactivation speed set in the parameters is attained or by the forced-lowering function.

TEBS E2.5

## Traction help "off-road"

As soon as the speed threshold set in the parameters has been attained, the function reverts to standard traction help. This is also switched off when the preset threshold value (speed and pressure) is attained.

TEBS E4

The traction help can be activated by engaging reverse gear. Here, the cable to the reversing lamp on the trailer vehicle must be monitored by TEBS E or the electronic extension module.

## Switch connection

The following cabling options can be considered for installing the switch. The diode is only required for the parameters *Ground* and *Positive (+24v)* and can be omitted for the parameters *Positive only (+24v only)* or *Ground only*.

### Trailer / signal from towing vehicle +24 V

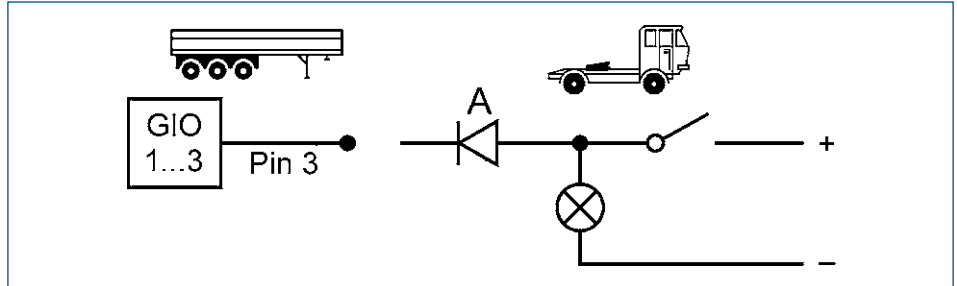

### Trailer / signal from towing vehicle - (ground)

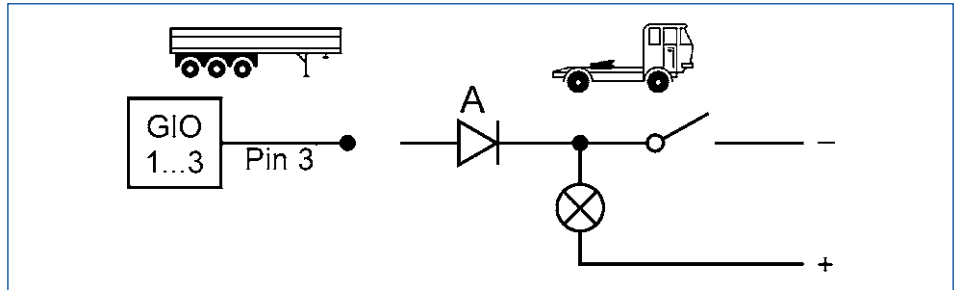

#### LEGEND

A	Diode
---	-------

### Button in trailer

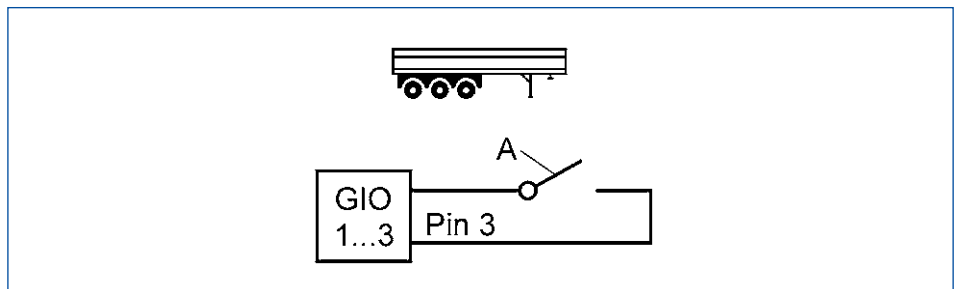

#### LEGEND

A	Switch
---	--------

## Parameter setting

The traction help and control method are configured in the TEBS E diagnostic software in *tab 5, Lifting Axle Control*.

## 6.6 External axle load sensor

### Vehicle type

All trailers with air suspension or hydro-pneumatic suspension.

### Purpose

An external axle load sensor can also be used instead of, or in addition, to the internal axle load sensor.

### For axle c-d

#### Vehicle type

Vehicles with hydraulic suspension, for example, because they may require suspension pressures of up to 200 bar (vehicles that can no longer be connected to the TEBS E Modulator because of the high pressures).

The external axle load sensor may be retrofitted on the main axle should the internal sensor fail. This avoids the need to replace the module and more cost-efficient repairs can be carried out instead.

---

**TEBS E2**

In the case of vehicles with hydraulic suspension, the right and left axle loads can be determined separately by using a second pressure sensor attached to the axle c-d. To ensure that the vehicle does not overbrake or underbrake when laden with different loads on each side, this function can be used to determine an average value for the two external pressure sensors.

This average value is used to determine the braking pressure and output the axle load.

This function is not suitable for drawbar trailers.

---

### For axle e-f

#### Vehicle type

Drawbar trailer, semitrailer (only 3M) with lifting axles or tag axles, OptiTurn™ / OptiLoad™

#### Purpose

More precise determination of the axle loads.

#### Function

Transmits the total weight of the trailer via the ISO 7638 plug connection to the towing vehicle and shows it on the display.

If a SmartBoard is installed, the separate loads of the drawbar trailer axles (front and rear axles) can also be displayed.

## Components

PART NUMBER	FIGURE	DESCRIPTION
441 044 101 0 441 044 102 0		<p>Pressure sensor</p> <ul style="list-style-type: none"> <li>■ 0 to 10 bar</li> <li>■ Cable for pressure sensor 449 812 XXX 0</li> </ul> <p><b>Use only at the responsibility of the vehicle manufacturer, depending on the vehicle construction.</b></p>

## Parameter setting

The external axle load sensors are configured in the TEBS E diagnostic software in *tab 8, General Functions*.

Which GIO slot is to be used is defined in *tab 11, Connectors*.

## 6.7 Dynamic wheelbase control

### 6.7.1 Manoeuvring assistance (OptiTurn™)

#### Vehicle type

Semitrailers with 2 or 3 axles, rear axle as a tag axle or lifting axle.

Central axle trailer:

#### Purpose

Increasing manoeuvrability.

Can be used as an alternative to a trailing steering axle.

#### Function

OptiTurn™ is able to detect tight bends from the differing wheel speeds and relieves the rear axle accordingly as configured in the manoeuvring assistance system. This causes the centre of rotation of the axle unit to "migrate" from the central axle between the two loaded axles remaining on the ground, reducing the turning circle and improving the manoeuvrability of the road train.

The relief of the third axle can be defined in the parameter settings. This prevents overloading of the other axles on the trailer vehicle.

#### Benefits

- Reduced tire wear in tight bends.
- Can reduce the need for the steering axle and steering axle control.
- Improved manoeuvrability, even when reversing.

#### System requirements

The vehicle must be equipped with ECAS or with eTASC and an LACV-IC on the last axle. This is necessary to ensure that the level is readjusted quickly to

normal level (thus quickly reducing the wheelbase) when the last axle is relieved as the vehicle drives into a bend.

- ECAS (eTASC)
- 4S/3M on the last axle
- LACV-IC
- Additional pressure sensor on axle e-f

## Legally defined turning circle

German force circuit regulations stipulate the maximum turning circle radius permissible by law for trailer vehicles. The maximum outer diameter of the circle is 25 m, the maximum inner diameter is 10.6 m. The legally regulated turning circle radius is easily adhered to with OptiTurn™.

## Activating OptiTurn™

Automatic and manual activation options are available.

### Automatic activation

- **After driving at a higher speed and when the speed drops below a parameterised speed (max. 30 km/h):** The function starts with a delay of 60 seconds. The function is deactivated when the parameterised speed is exceeded.
- **Immediately when a curve is detected:** The function starts immediately on entering a bend below the defined speed. The function is deactivated once the vehicle has negotiated the bend.
- **Only with partial/full load:** With unladen vehicles, the function remains deactivated automatically. TEBS E switches to the automatic lifting axle function.

---

TEBS E4

Optionally the function can be automatically deactivated if another lifting axle is already lifted.

---

Pay attention to the permitted axle loads stipulated in the axle manufacturer's specifications.

If the Tristop™ cylinders are installed on axles 2 and 3, the parameter *Interrupt lifting axle function (OptiTurn™ / OptiLoad™) when parking brake is applied* must be selected in the TEBS E diagnostic software in *tab 5, Lifting Axle Control*.

## Control options

### Permanently automatic

The function starts independently of the driver in accordance with the general conditions set in the parameters.

If a SmartBoard is installed, the automatic function can be temporarily deactivated, for instance to save air.

The automatic function can also be completely switched off and on again using the SmartBoard.

The manoeuvring assistance button or the Trailer Remote Control (only in combination with the electronic extension module and **from version TEBS E2**) can be used to put the automatic function into forced lowering mode by pressing the button for > 5 seconds.

OptiTurn™ is activated again after the ignition has been switched off and on again.

---

**TEBS E2.5** OptiTurn™ and OptiLoad™ can be deactivated separately using the SmartBoard.

---

**TEBS E4** **Automatic start of OptiTurn™ when reversing**  
OptiTurn™ is started automatically when reversing if the reversing lamp is being monitored with TEBS E or the electronic extension module. The function is deactivated again after longer stationary periods or when the vehicle moves forward.  
If the SmartBoard or Trailer Remote Control has deactivated the automatic OptiTurn™ function, the OptiTurn™ function is also deactivated when reversing.

---

## Manual control

OptiTurn™ remains deactivated until it is reactivated by actuating the manoeuvring assistance button.

The function is started manually by pressing the manoeuvring assistance button: Press manoeuvring assistance button once.

The SmartBoard or Trailer Remote Control (only in combination with the electronic extension module and **from version TEBS E2**) can be as alternatively used instead of the button.

OptiTurn™ is deactivated again by switching the ignition off and back on again, or by specifically switching it off using the SmartBoard, Trailer Remote Control or manoeuvring assistance button.

---

**!** Further operating information ▶ chapter "10.5 Operating OptiLoad™ / OptiTurn™", page 192 and ▶ chapter "10.2 Operation with the Trailer Remote Control", page 181.

---

## Parameter setting

OptiTurn™ is configured in the TEBS E diagnostic software in *tab 5, Lifting Axle Control*.

Which GIO slots are to be used is defined in *tab 11, Connectors*.

## 6.7.2 Drawbar load reduction (OptiLoad™)

### Vehicle type

Semitrailers with 2 or 3 axles, rear axle as a tag axle or lifting axle.

### Purpose

To avoid overloading the fifth-wheel coupling and towing vehicle drive axle on semitrailers with loads that are unevenly distributed in the direction of the towing vehicle.

- The load does not have to be distributed over the loading bed.
- Reduces the risk of a traffic fine due to overloading the towing vehicle.



## Function

Lifting or relieving pressure on the rear axle improves the distribution of the load between the towing vehicle and the trailer, thus avoiding overloading of the rear axle of the towing vehicle. In this case, the rear axle of the semitrailer acts as a counterweight to the load.

After the ignition is turned on, TEBS E determines the load status and relieves the last axle as required.

### TEBS E4

As of TEBS E4, the axle load is measured and the axle is relieved as required after the vehicle moves off through until the configured RtR speed is attained.

The OptiLoad™ function can be implemented in tandem with the OptiTurn™ function.

Whereas OptiTurn™ is only used at low speeds, there is no speed limitation for OptiLoad™.

## System requirements

- 4S/3M on the last axle
- LACV-IC (The vehicle must be equipped with an LACV-IC on the last axle to maintain the pressure.)
- Additional pressure sensor on axle e-f

## OptiLoad™ Parameter setting

### Selecting the activation conditions

- Automatically on exceeding a speed (can be set in the parameters from 0 km/h).
- Only for partial/full load: the function is automatically disabled on unladen vehicles; the ECU switches to the automatic lifting axle mode.
- Manual with button (press manoeuvring aid button 2x).
- Using the SmartBoard or Trailer Remote Control.

### Selecting the deactivation conditions

- Automatically below a defined speed.
- Pressure value limitation where the function is deactivated (the function is active below the bellows pressure configured in the parameters).
- Manually by button control; optionally using the SmartBoard or Trailer Remote Control.

TEBS E2.5

## Winter operation for OptiLoad™

Second lifting axle characteristic curve when the automatic OptiLoad™ function is deactivated: If the automatic OptiLoad™ function is deactivated using the SmartBoard or Trailer Remote Control, this parameter can be used to regulate a second lifting axle characteristic curve. This function has to be deactivated in winter, for example, so that the towing vehicle's drive axle gains more traction.

Without this parameter, the standard characteristic curve for the automatic lifting axle function would stay active, causing the lifting axles not to raise on partially laden or unladen vehicles, for example.

The second characteristic curve can delay lifting or prevent it altogether.

! The pressure for the drawbar load reduction may not exceed a maximum of 100 % of the "laden" bellows pressure.

## Control options

### Permanently automatic

The function starts independently of the driver in accordance with the general conditions set in the parameters.

If a SmartBoard is installed, the automatic function can be temporarily deactivated, for example to save air (up to TEBS E2, the automatic function can only be activated/deactivated simultaneously for both OptiTurn™ and OptiLoad™). OptiLoad™ is reactivated after the ignition has been switched off and on again (trip function).

The automatic function can also be switched off completely and then reactivated again using the SmartBoard.

The manoeuvring assistance button or Trailer Remote Control can be used to put the automatic function into forced lowering mode by pressing the button for > 5 seconds (only in combination with the electronic extension module and **from version TEBS E2**). OptiLoad™ is reactivated after the ignition has been switched off and on again (trip function).

### Manual control

As soon as OptiLoad™ is deactivated the system stays in this status until it is reactivated via the SmartBoard or by actuating the Manoeuvring assistance button (press twice).

The SmartBoard or Trailer Remote Control can be used instead of the button (only in combination with the electronic extension module and **from version TEBS E2**). OptiLoad™ is deactivated again after the ignition is switched off and back on again, or by specifically switching it off with the SmartBoard, Trailer Remote Control or the manoeuvring assistance button.

! Further operating information ▶ chapter "10.5 Operating OptiLoad™ / OptiTurn™", page 192 and ▶ chapter "10.2 Operation with the Trailer Remote Control", page 181.

## 6.7.3 Connecting the components

### OptiLoad™ / OptiTurn™ in conjunction with ECAS

For optimum and efficient use of the functions (response and control behaviour), it is necessary to use an electronically controlled air suspension system (for lifting & lowering, and to control the Opti functions axle).

Additionally, an EBS relay valve with external bellows pressure sensor e-f must be installed on the last axle to adjust the optimum braking pressure when braking with a partially relieved axle (Opti function is activated), and to prevent the wheels on the last axle from locking.

When using a tag axle, a residual pressure maintenance valve should be installed, or the function *Tag axle residual pressure regulation* has to be activated in the TEBS E diagnostic software. This can prevent damage to the axle or support bellows when there is no load at all on the axle.

#### Extract from schematic diagram 841 802 235 0

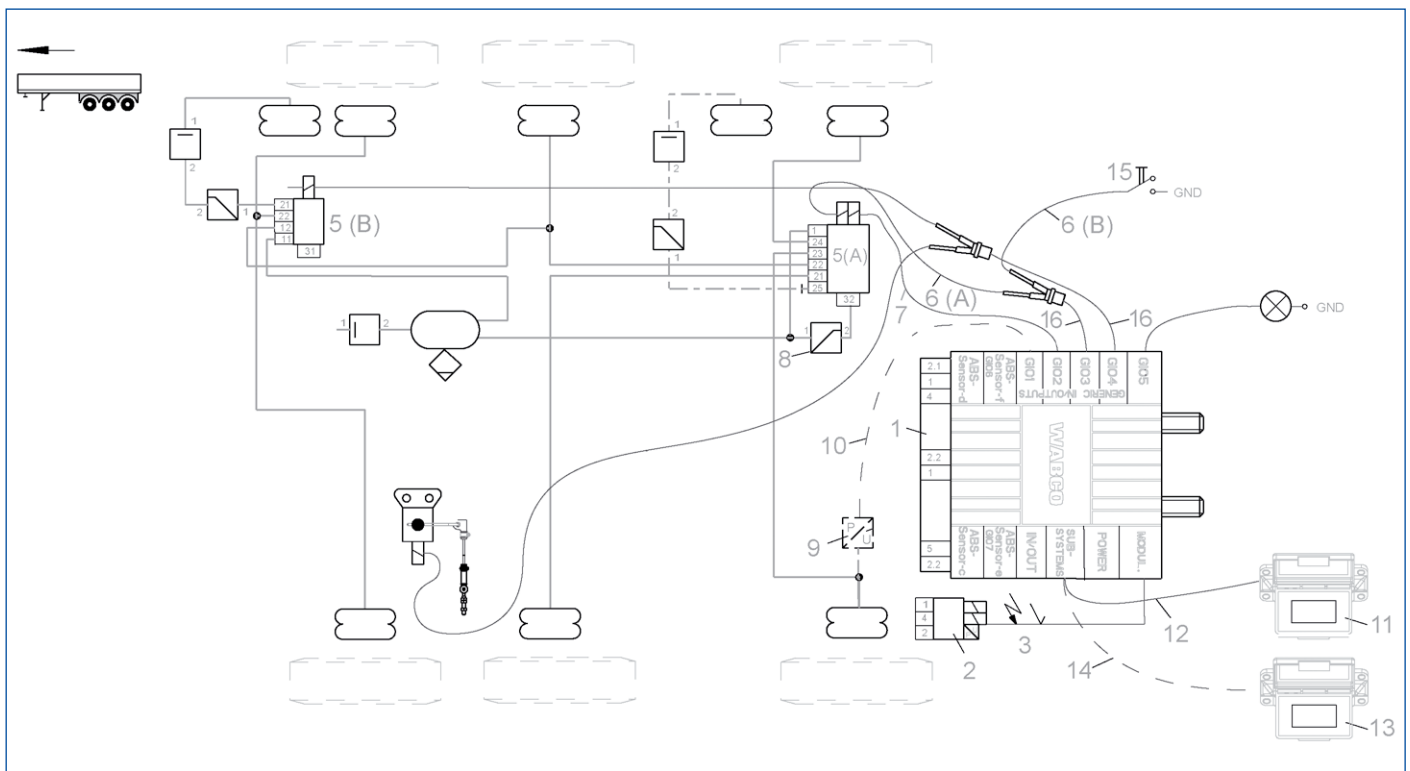





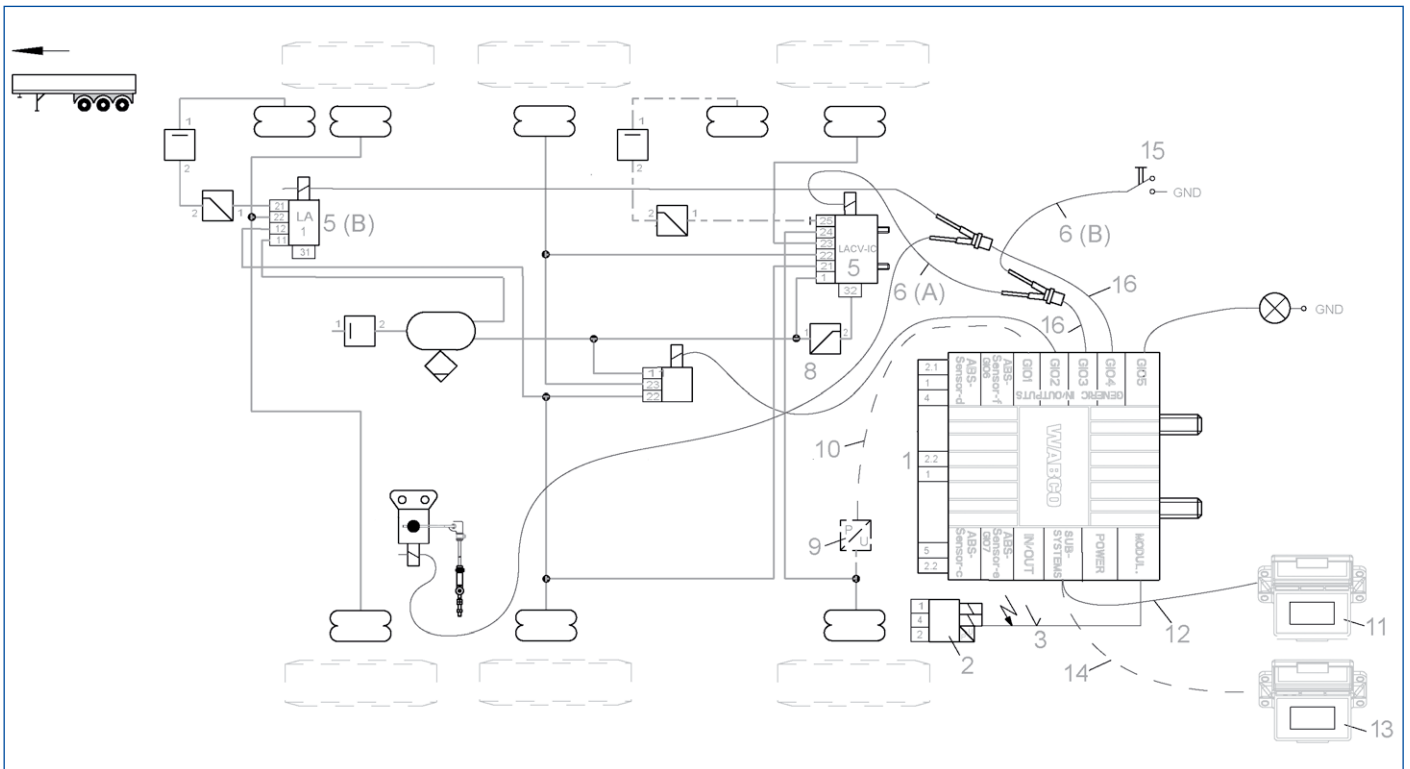

# GIO functions

Extract from schematic diagram 841 802 236 0



ITEM	PART NUMBER	FIGURE	DESCRIPTION
1	480 102 06X 0		TEBS E Modulator (Premium)
2	480 207 XXX 0		EBS relay valve (3rd modulator)
3	449 429 XXX 0		Cable for EBS relay valve
5	472 905 111 0		ECAS solenoid valve <ul style="list-style-type: none"> <li>2-point control, only possible in combination with the electronic extension module and <b>from version TEBS E2</b> ▶ chapter "7.1 Electronic extension module", page 132.</li> </ul>
5 (A)	472 905 114 0		ECAS solenoid valve <ul style="list-style-type: none"> <li>1-point control: double block with lifting/lowering function and lifting axle control</li> </ul>

# GIO functions

ITEM	PART NUMBER	FIGURE	DESCRIPTION
5 (B)	463 084 100 0		<p>Lifting axle valve (LACV-IC)</p> <ul style="list-style-type: none"> <li>■ When using a second lifting axle for the first axle: <ul style="list-style-type: none"> <li>■ up to version TEBS E2: Only the spring-returned lifting axle valve can be used on the first axle in combination with the ECAS double block.</li> <li>■ As of TEBS E2: An additional third pulse-controlled valve can also be installed.</li> </ul> </li> </ul>
6 (A) 6 (B)	449 761 030 0		Cable for ECAS solenoid valve or LACV-IC
7	449 445 XXX 0		Cable for ECAS valve/lifting axle valve
8	475 019 XXX 0		<p>Residual pressure keeper valve</p> <ul style="list-style-type: none"> <li>■ Alternative to maintaining residual pressure with LACV-IC</li> </ul>
9	441 044 XXX 0		<p>External bellows pressure sensor</p> <p><b>Use only at the responsibility of the vehicle manufacturer, depending on the vehicle construction.</b></p>
10	449 812 XXX 0		Cable for pressure sensor (optional)
11	446 192 11X 0		SmartBoard
12	449 911 XXX 0		Cable for SmartBoard (optional)
13	446 156 022 0		ECAS control box (optional)
14	449 627 060 0		Cable for ECAS control box (optional)
15	Not part of WABCO's scope of supply		Manoeuvring assistance button
	446 122 080 0		<p>Trailer Remote Control (optional)</p> <ul style="list-style-type: none"> <li>■ Can only be used in combination with the electronic extension module and <b>from version TEBS E2 Premium</b></li> <li>■ Scope of delivery: <ul style="list-style-type: none"> <li>■ Connection cable between the Trailer Remote Control and the fuse box in the truck</li> <li>■ Mounting bracket</li> </ul> </li> </ul>
16	449 629 XXX 0		GIO Y-distributor

## OptiLoad™ / OptiTurn™ in combination with a conventional air suspension

The functions cannot be exploited to their full capability and efficiency with this set of equipment. For this reason, WABCO advises against using a conventional air suspension system in conjunction with the Opti functions.

### Recommendations for the air supply

RESERVOIR SIZES FOR AIR SUSPENSION	APPLICATION
80 litres	one lifting axle
100 litres	two lifting axles
120 litres	OptiLoad™ or OptiLoad™

### Recommendations for line cross-sections for good response times

CONNECTION	CROSS-SECTION
Air spring reservoir – ECAS / lifting axle valve	12 mm
ECAS / lifting axle valve – support bellows	12 mm

### Parameter setting

The settings are configured in the TEBS E diagnostic software in *tab 5, Lifting Axle Control*.

Which GIO slots are to be used is defined in *tab 11, Connectors*.

## 6.8 Forced lowering and deactivation of the lifting axle function

### Vehicle type

All trailer vehicles with lifting axle.

### Purpose

To switch off the automatic axle lifting function to lower the raised lifting axles.

### Function

The function can be activated with a button, switch to ground or using the SmartBoard or Trailer Remote Control. The lifting axle control is deactivated.

#### Forced lowering with switch

The switch is closed: All axles are lowered. SmartBoard control has priority over the switch.

The switch is opened: The automatic lifting axle control is activated.

More information on operation ▶ chapter "10.6 Operating the lifting axles", page 192.

#### Forced lowering with button / SmartBoard

The button is pressed for longer than 5 seconds: All axles are lowered.

The button is pressed for less than 5 seconds: The automatic lifting axle control is activated.

More information on operation ▶ chapter "10.6 Operating the lifting axles", page 192.

## Forced lowering with the Trailer Remote Control

Information on operating the Trailer Remote Control ▶ chapter "10.2 Operation with the Trailer Remote Control", page 181.

### TEBS E4

The lifting axle function can be permanently deactivated in addition to forced lowering. Up to two separately controlled lifting axles can be permanently lowered individually by means of two separate switches or using the SmartBoard.

Two separately controlled lifting axles can be lowered individually by means of two separate switches or using the SmartBoard.

If the load status only permits one axle to be raised, this function can be used to lower a specific lifting axle so that the other lifting axle is automatically raised as a result.

OptiLoad™ and OptiTurn™ are deactivated at the same time when the rear lifting axle is forcibly lowered.

The traction help is deactivated at the same time when the front lifting axle is deactivated.

! Lifting axles are only raised by the automatic lifting axle control if the vehicle's threshold values for speed and bellows pressure are within the limits set in the parameters.

Input levels (switched positive or ground) sent by the towing vehicle can be selected in the TEBS E diagnostic software.

There are two ways to define the parameters for the forced lowering function in the TEBS E diagnostic software:



- Forced lowering affects all the lifting axles or only the 2nd lifting axle.
- Forced lowering is possible by switch, button, Trailer Remote Control or SmartBoard.

## Connecting the components

The following components can be used for indication and operation:

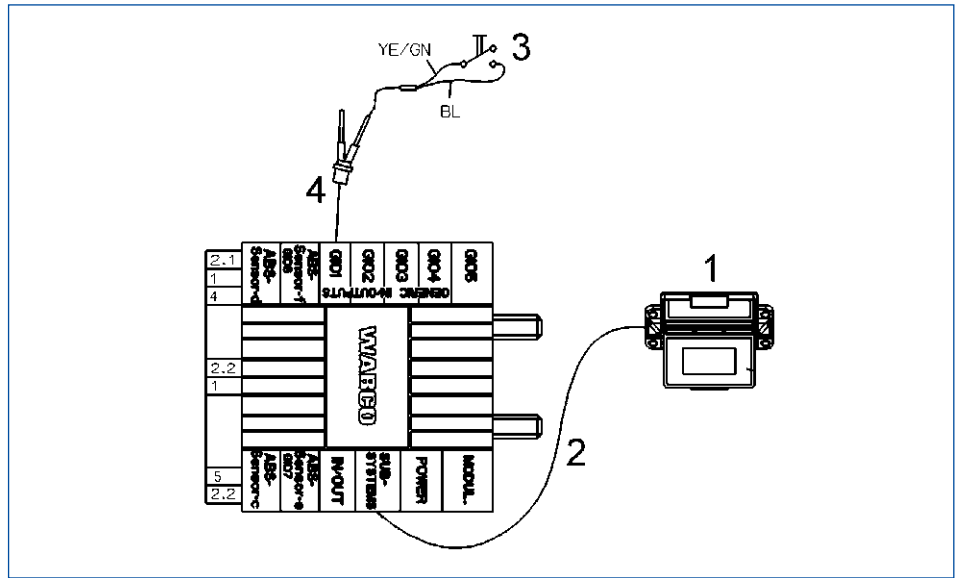
**Extract from schematic diagram 841 802 157 0**



ITEM	PART NUMBER	FIGURE	DESCRIPTION
1	446 192 11X 0		SmartBoard
2	449 911 XXX 0		Cable for SmartBoard
3	Not part of WABCO's scope of supply		Button / switch (optional)
4	449 535 XXX 0		Universal cable (optional) ■ 4-pin, open
	446 122 080 0		Trailer Remote Control (optional) ■ Can only be used in combination with the electronic extension module and <b>from version TEBS E2 Premium</b> . ■ Scope of delivery: ■ Connection cable between the Trailer Remote Control and the fuse box in the truck ■ Mounting bracket

## Parameter setting

The settings are configured in the TEBS E diagnostic software in *tab 5, Lifting Axle Control*.

Which GIO slots are to be used is defined in *tab 11, Connectors*.



## 6.9 Active RSS signal (from TEBS E2)

The TEBS E Modulator is equipped with the RSS function. While the RSS function is active and there is an active RSS intervention, the stop lights on the vehicle are not actuated actively.

In addition, with the RSS active signal it is also possible to actuate the stop lights from the TEBS E when the RSS function is active. For this purpose, it is necessary to parameterise this output with the GIO function.

It can be actuated via a relay. The supply voltage for the stop lights must come from the 15-pin plug connection (ECE regulation).

### Components

PART NUMBER	DESCRIPTION
Not part of WABCO's scope of supply	Relay
449 535 XXX 0	Universal cable

### Parameter setting

The setting is configured in *tab 8, General Functions*.

Which GIO slots are to be used is defined in *tab 11, Connectors*.

## 6.10 Active ABS signal (from TEBS E2)

### Vehicle type

All trailers.

### Purpose

During an ABS control process, a retarder can be deactivated by a relay to prevent the wheels from being locked by it, for example.

### Function

WABCO switches the supply voltage to the selected GIO output when the ABS control function is active during a braking action.

### Components

PART NUMBER	DESCRIPTION
Not part of WABCO's scope of supply	Relay
449 535 XXX 0	Universal cable

### Parameter setting

The setting is configured in *tab 8, General Functions*.

Which GIO slots are to be used is defined in *tab 11, Connectors*.

## 6.11 Brake lining wear indicator (BVA)

### Vehicle type

All trailer vehicles with disc brakes.

### Purpose

Wear indicators (wires integrated into the brake lining) monitor the wear of both linings of a disc brake.

### Function

Wear indicators can be connected on up to 6 brakes on the ECU. All wear indicators are connected in series and are connected to the wear input. These are operated with the supply voltage (24 V / 12 V).

#### **Warning indicator / warning lamp**

If the wear indicators indicates that the wire is worn through for a period of at least 4 seconds (or longer) , a voltage will be measured at the lining wear sensor and the warning will be activated. The warning indicator / warning lamp will warn the driver if the end value for lining wear has been reached (100 % brake lining wear).

When the ignition is switched on, the warning indicator / warning lamp (yellow) flashes in 4 cycles = 16 times. The warning indicator / warning lamp no longer lights up when the vehicle's speed exceeds 7 km/h. Replacing the wear indicators is automatically detected by the system when the linings are changed. The warning level is deactivated after 8 seconds.

In systems with Trailer Central Electronic, the wear information is determined by the Trailer Central Electronic. It is the TEBS E that warns the driver or triggers the warning indicator / warning lamp. This is necessary because only an ECU can execute triggering the warning indicator / warning lamp in the event of service information having accumulated. If a SmartBoard is installed, the warning will also be displayed on the SmartBoard.



### **Saving the data for the lining change**

The last five lining changes (including odometer and operating hours when the second warning level occurred) are stored in the ECU and can be read out via the TEBS E diagnostic software.

## Connecting the components

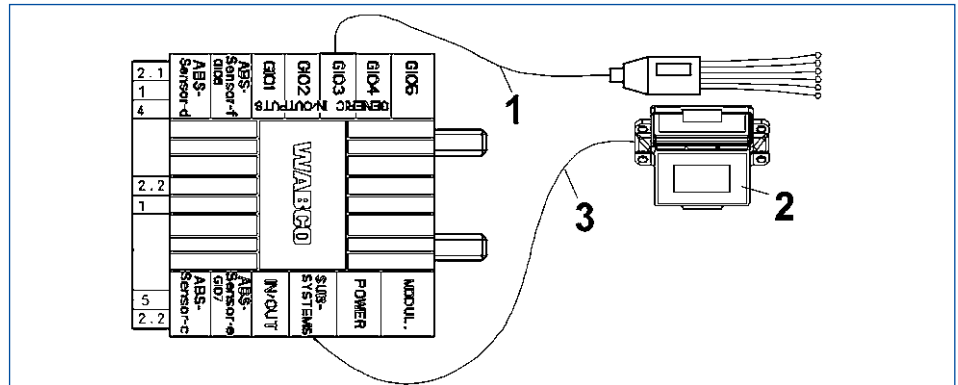
Extract from schematic diagram 841 802 157 0



ITEM	PART NUMBER	FIGURE	DESCRIPTION
1	449 816 XXX 0		Cable for wear indicator
2	446 192 11X 0		SmartBoard (optional)
3	449 911 XXX 0		Cable for SmartBoard (optional)
	Not part of WABCO's scope of supply		Warning lamp
	446 122 080 0		Trailer Remote Control (optional) <ul style="list-style-type: none"> <li>■ Can only be used in combination with the electronic extension module and <b>from version TEBS E2 Premium</b>.</li> <li>■ Scope of delivery:                             <ul style="list-style-type: none"> <li>■ Connection cable between the Trailer Remote Control and the fuse box in the truck</li> <li>■ Mounting bracket</li> </ul> </li> </ul>

## Parameter setting

This function is activated in the TEBS E diagnostic software in *tab 4, Standard Functions*.

Which GIO slots are to be used is defined in *tab 11, Connectors*.

Connecting the lining wear indication to GIO5 can cause load peaks in certain cases and should be avoided.

## 6.12 Power supply and data communication at GIO5

### Vehicle type

All trailers.

### Purpose

Power supply from connected systems, e.g. Telematics.

### Telematics unit

The telematics unit can be connected to the SUBSYSTEMS slot or at GIO5 (only with TEBS E Premium).

WABCO recommendation: Connect the telematics unit to GIO5 so that the subsystems connector can be used for the SmartBoard or OptiTire™, for example.

A stand-by time for charging a connected battery after the ignition is turned off can be defined in the TEBS E diagnostic software. In this case, the CAN bus is switched off – or the message is sent indicating that the vehicle was switched off – and only the battery is charged. The time for charging corresponds to the time for ECAS stand-by operation.

### Parameter setting

The telematics are defined in the TEBS E diagnostic software in *tab 4, Standard Functions*.

The connection to the subsystem or GIO5 is set in *tab 11, Connectors*.

## 6.13 Speed signal

### Vehicle type

All trailers.

### Purpose

In addition to the ISS speed switch, which only outputs switch settings, TEBS E can provide a speed signal for evaluation by the connected systems, e.g. for controlling steering axles or for closing tank covers.

### Function

The TEBS E Modulator provides a speed signal in the form of a pulse-width modulated rectangular signal.

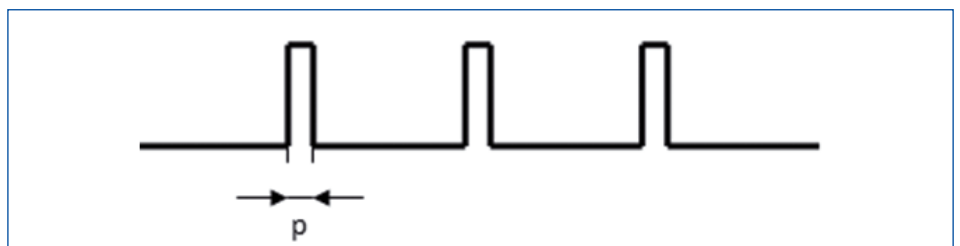

The ISS is switched dependent upon the reference speed  $v_{\text{refspeed}}$  created in the ECU.

The speed pulse has the following format:

$$p = 195 \text{ ms} + v * 5 \text{ ms} / \text{km/h}$$

## Components

PART NUMBER	DESCRIPTION
449 535 XXX 0	Universal cable, 4-pin, open

## Parameter setting

This function is activated in the TEBS E diagnostic software in *tab 8, General Functions*.

Which GIO slots are to be used is defined in *tab 11, Connectors*.

## 6.14 Steady positive voltage 1 and 2

### Vehicle type

All trailers.

### Purpose

Two permanent voltage supplies are available. Using corresponding Parameter setting, a steady positive voltage (terminal 15) can be outputted to supply connected electronic systems or solenoid valves. The stand-by time corresponds to the stand-by time for the ECU.

### Function

Two 24 V outputs with a steady load of max. 1.5 A can be connected to the Trailer EBS E Modulator.

Both outputs can be parameterised and switched in parallel for a higher power consumption (up to 3 A).

The output is monitored only when the TEBS E is switched on. Optionally, monitoring can be deactivated if, for example, components are connected via a switch.

#### TEBS E2.5

An optional parameter can be used to deactivate a stand-by of the continuous power supply. Otherwise the port continues to be supplied with power as specified by the parameter for the ECU standby time.

## Connecting the components

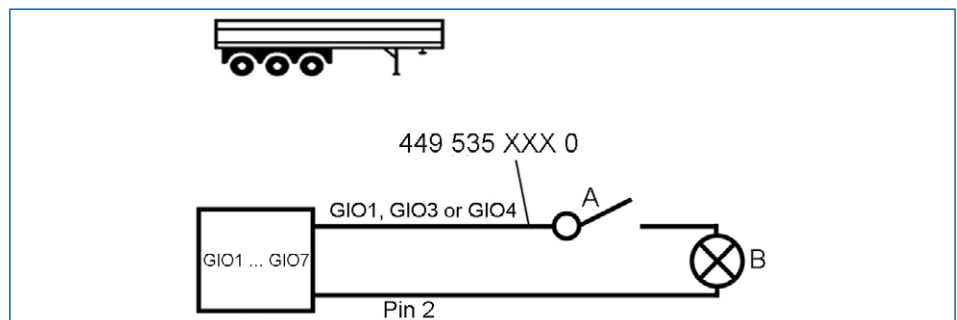

#### LEGEND

<b>A</b>	Switch	<b>B</b>	Load on steady positive voltage
----------	--------	----------	---------------------------------

PART NUMBER	DESCRIPTION
Not part of WABCO's scope of supply	Switch (optional)
449 535 XXX 0	Universal cable

## Parameter setting

This function is activated in the TEBS E diagnostic software in *tab 8, General Functions*.

Which GIO slots are to be used is defined in *tab 11, Connectors*.

## 6.15 Road finisher brake

### Vehicle type

Dumper

### Purpose

The "road finisher brake" function is used to specifically brake trailers with tipper bodies when driving in front of road finishers. In this case, the vehicle trailer is pushed, while tipping, by the road finisher.

### Function

If this function is activated, the trailer vehicle is braked by the TEBS E Modulator.

Mechanical switches can be used to activate the operation (road finisher mode on/off), and an unloading level switch can be used to position the tipping body (pushbutton or proximity switch). When using ECAS valves, tipping of the tipper body can be detected via the unloading level switch ▶ chapter "6.3.2 Driving levels", page 75.

The unloading level switch can be activated or deactivated based on the customer's wishes. An optional switch can be provided for this or a parameter or a shut-off on the SmartBoard.

The control pressure defined in the TEBS E diagnostic software can be changed manually using the SmartBoard or Trailer Remote Control. The minimum control pressure in this case is 0.5 bar and the maximum control pressure is 6.5 bar. The value last set via the SmartBoard or Trailer Remote Control when switching the function off is valid again when switched back on.

This function is automatically switched off at a speed of  $v > 10$  km/h.

### Controller

#### Proximity switch

More detailed information on the proximity switch ▶ chapter "6.15.1 Proximity switch", page 106.

## Mechanical switch I for road finishers to ground

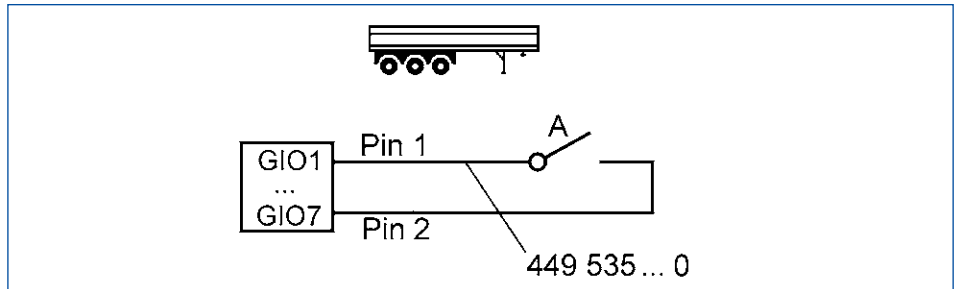

### LEGEND

**A** "Road finisher brake on / off" switch

## Mechanical switch II for road finishers and unloading level to ground

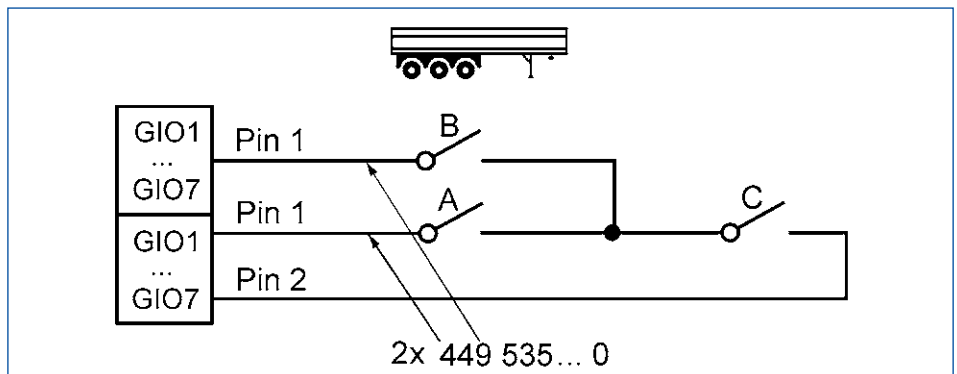

## Mechanical switch III for road finishers to positive at analogue TEBS E input

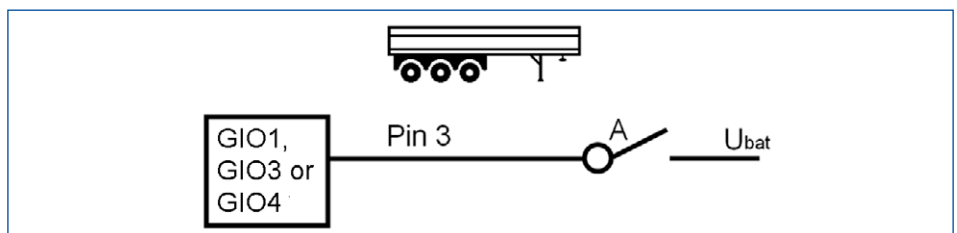

## Mechanical switch IV for road finishers to positive at digital TEBS E input (resistance cable not supplied by WABCO)

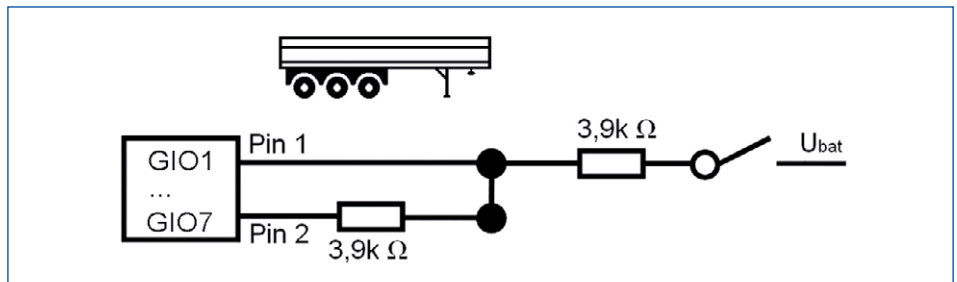





### LEGEND

<b>A</b>	"Road finisher brake on / off" switch	<b>B</b>	"Unloading level on/off" switch
<b>C</b>	Raise/lower dumper		

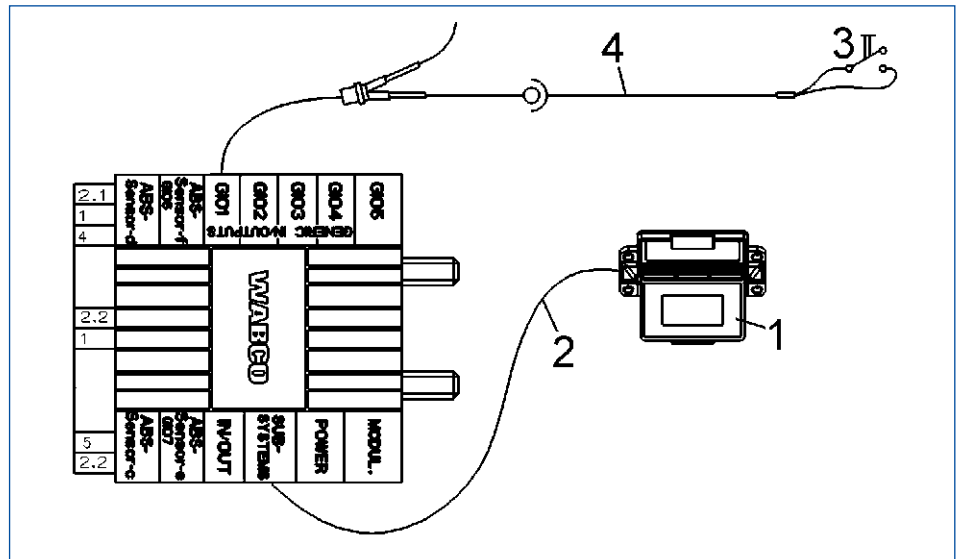
## Connecting the components

Extract from schematic diagram 841 802 198 0



ITEM	PART NUMBER	FIGURE	DESCRIPTION
1	446 192 11X 0		SmartBoard
2	449 911 XXX 0		Cable for SmartBoard
3	Not part of WABCO's scope of supply		Switch
4	449 535 XXX 0		Universal cable (optional) ■ 4-pin, open
	446 122 080 0		Trailer Remote Control (optional) ■ Can only be used in combination with the electronic extension module and <b>from version TEBS E2 Premium</b> . ■ Scope of delivery: ■ Connection cable between the Trailer Remote Control and the fuse box in the truck ■ Mounting bracket
	446 105 523 2		Green warning lamp ■ Indicates the status ■ from TEBS E4



## Parameter setting

It is activated in the TEBS E diagnostic software in *tab 6, Braking Functions*.

Which GIO slots are to be used is defined in *tab 11, Connectors*.

### Road finisher brake parameters

The speed (max. 10 km/h) up to which the function is active must first be set in the TEBS E diagnostic software in *tab 6, Braking Functions*. Then default pressure for actuating the braking pressure  $p_m$  of the application pressure up to a maximum of 6.5 bar is set in the parameter *Road Finisher Brake*.

You can define whether the actuated braking pressure is adjusted depending on the load during road finisher operation (dynamic LSV).

If a SmartBoard is installed, one switching input can be dispensed with by activating the function solely via the SmartBoard.

#### TEBS E2.5

The road finisher brake pressure can also be adjusted without a SmartBoard using the parking brake in the towing vehicle.

In the pressure range to be set, the spring-type actuator in the towing vehicle is not yet exhausted so that the parking brake only generates a braking force in the trailer.

To increase the braking pressure, the pressure must be adjusted slowly using the lever, which is then released suddenly.

The system detects the manual setting through the high pressure gradient thus produced, saves this value and adjusts the pressure accordingly.

To reduce the value, the current value must be briefly exceeded using the lever before it is gradually released again. This value is deleted again following an ignition reset.

The road finisher brake can be activated by a mechanical switch as well as by a proximity switch.

Parameters for deactivating the unloading level can be set in the TEBS E diagnostic software.

A 2-pin proximity switch can be connected (to GIO4, pins 1 and 3, cable 449 535 XXX 0).

This proximity switch can be used for the "Unloading level" and "Road finisher brake" functions. Every proximity switch has a different switching threshold relating to the distance to the tipping body object to be detected.

If both functions are to be active, two additional switching inputs are required so that both functions can be switched on and off separately.

#### TEBS E4

The road finisher brake can be indicated by a lamp attached to the outside of the vehicle, for example.

This is done by creating a digital function with the internal input signal *Road finisher brake active* in the TEBS E diagnostic software in *tab 9, Function Modules*.

## Operation

Operating information:

- ▶ chapter "10.3 Operating the ECAS level control", page 189
- ▶ chapter "10.2 Operation with the Trailer Remote Control", page 181

## 6.15.1 Proximity switch

### Vehicle type

All trailers with an unloading level option or road finisher brake.

### Purpose

The proximity switch can be used as a switch for the unloading level control functions, for actuating the road finisher brake, or for controlling the SafeStart function.

The following proximity switch can be used to actuate the functions named above without contact:

- Telemecanique XS7C1A1DAM8
- Schönbuch Electronic IO25CT 302408
- Balluff BES M30MF-USC15B-BP03
- Schönbuch Electronic MU1603111

### Connection of the proximity switch

#### Proximity switch for activating the road finisher / unloading level (Figure 1)

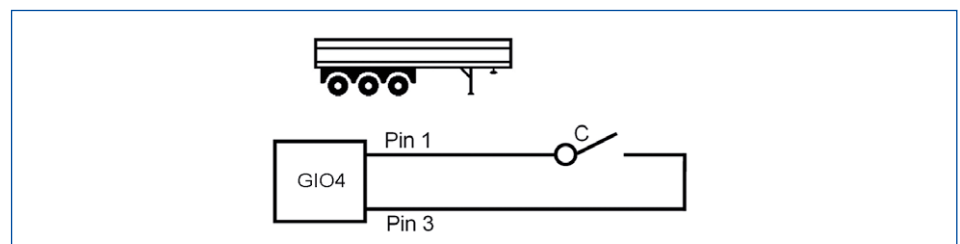

#### LEGEND

<b>C</b>	Proximity switch
----------	------------------

#### Proximity switch with separate deactivation of the road finisher and unloading level (Figure 2)

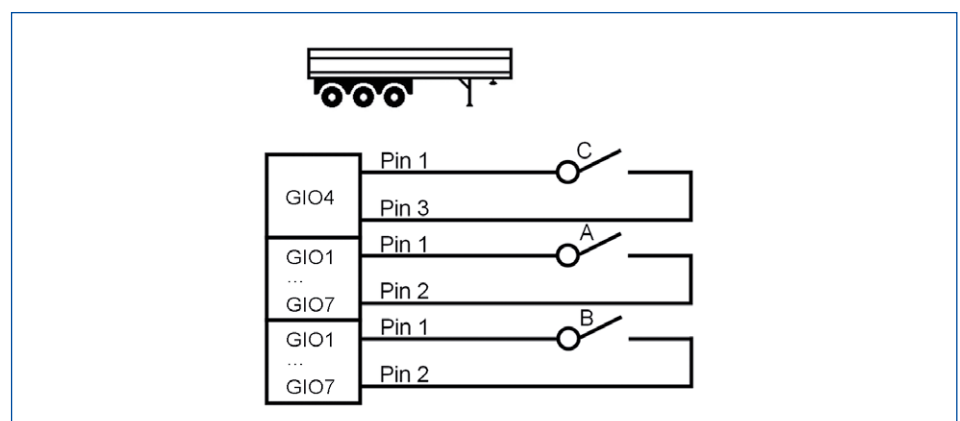

#### LEGEND

<b>A</b>	"Road finisher brake on/off" switch	<b>B</b>	"Unloading level on/off" switch
<b>C</b>	Proximity switch		

## Parameter setting

If just one function is available (figure 1), parameters only need to be set for the proximity switch.

If both functions are to be available (figure 2), two additional switch inputs are required so that both functions can be switched on and off separately.

The switches for this must be configured as follows:

*Road finisher brake* = proximity switch and separate switch. Both switches must be closed here so that the road finisher function is actuated.

*Unloading level switch* = proximity switch and separate switch. Both switches must be closed here so that the unloading level starts up.

Proximity switches available on the market can have differing switching thresholds depending on the distance to the object to be registered.

WABCO suggests a value of 600  $\mu\text{A}$  for this, for trouble free operation of the proximity switches named above. The switching threshold for other switches can be set as required.

Which GIO slots are to be used is defined in the TEBS E diagnostic software in *tab 11, Connectors*.

## 6.16 Trailer Extending Control

### Vehicle type

Semitrailers or drawbar trailers that are adjustable in length and equipped with a 4S/3M system.

### Purpose

Equipped with this function, vehicles that are adjustable in length can be extended and retracted with greater convenience for the driver and without using additional tools (such as brake wedges or other components installed in the trailer).

### Function

The final multi-axle combination is braked and the trailer is extended by the towing vehicle.

The function has different modes of operation depending on the type of vehicle:

#### Semitrailer

On semitrailers, the function can be selected in combination with the parameter *Without automatic load-controlled braking LSV* in the TEBS E diagnostic software (in *tab 6, Braking Functions*).

If the function is activated by a switch or the SmartBoard, the multi-axle combination is braked with full braking pressure (without LSV characteristic curve) so that the trailer can be extended by driving the towing vehicle slowly.

#### Drawbar trailer



Here, the parameter *Brake rear unit only* can additionally be selected in the TEBS E diagnostic software in *tab 6, Braking Functions*. In this case, only the rearmost axle (axle group) is braked so that the towing vehicle can extend the trailer by driving slowly forwards.

## Connecting the components

The following components can be used for indication and operation:

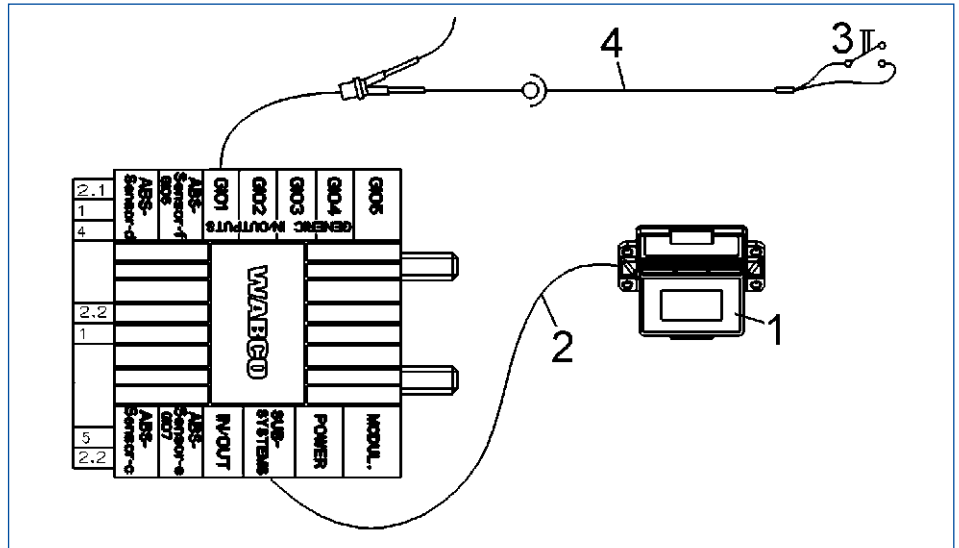
Extract from schematic diagram 841 802 290 0



ITEM	PART NUMBER	FIGURE	DESCRIPTION
1	446 192 11X 0		SmartBoard
2	449 911 XXX 0		Cable for SmartBoard
3	Not part of WABCO's scope of supply		Switch (optional)
4	449 535 XXX 0		Universal cable (optional) ■ 4-pin, open
	446 122 080 0		Trailer Remote Control (optional) ■ Can only be used in combination with the electronic extension module and <b>from version TEBS E2 Premium.</b> ■ Scope of delivery: ■ Connection cable between the Trailer Remote Control and the fuse box in the truck ■ Mounting bracket

## Parameter setting

This function is activated and configured in the TEBS E diagnostic software in *tab 6, Braking Functions*.

Which GIO slots are to be used is defined in *tab 11, Connectors*.

## 6.17 Actual vehicle length (Trailer Length Indication) (from version TEBS E4)

### Vehicle type

Trailer vehicle with adjustable length.

### Purpose

Displays the length of the vehicle using the SmartBoard.

### Function

The current extension length can be detected by means of proximity switches or mechanical switches on the telescope system.

Up to 4 switches can be permanently installed as a group. Shift gates or fields of view are arranged opposite the switches on the moving parts in the areas of the engaging positions.

The number of extension stages determines the number of switches. Two switches can detect 3 stages, three switches 7 stages, and four switches 15 stages.

Detection of the shift gates or fields of view occurs via the binary system. The table below illustrates the principles of the fields of view.

SWITCH 1	SWITCH 2	SWITCH 3	SWITCH 4	INDICATION
0	0	0	0	Length 0
1	0	0	0	Length 1
0	1	0	0	Length 2
1	1	0	0	Length 3
0	0	1	0	Length 4
1	0	1	0	Length 5
0	1	1	0	Length 6
1	1	1	0	Length 7
0	0	0	1	Length 8
1	0	0	1	Length 9
0	1	0	1	...

0 = switch open; 1 = switch closed

## Components

PART NUMBER	FIGURE	DESCRIPTION
446 192 11X 0		SmartBoard <ul style="list-style-type: none"> <li>■ Cable for SmartBoard: 449 911 XXX 0</li> </ul>
Not part of WABCO's scope of supply		Switch or proximity switch <ul style="list-style-type: none"> <li>■ Universal cable (for each switch): 449 535 XXX 0 (4-pole, open)</li> </ul>
446 122 633 0		Connection box

## Connecting the components

A free GIO slot on the TEBS E Modulator or electronic extension module is required for each switch or proximity switch.

The GIO4 slot will always be required if proximity switches are used. One of the contacts of each proximity switch is connected to pin 3 of the GIO4 slot.

The proximity switches can be connected according to the diagram at the bottom of a cabling box.

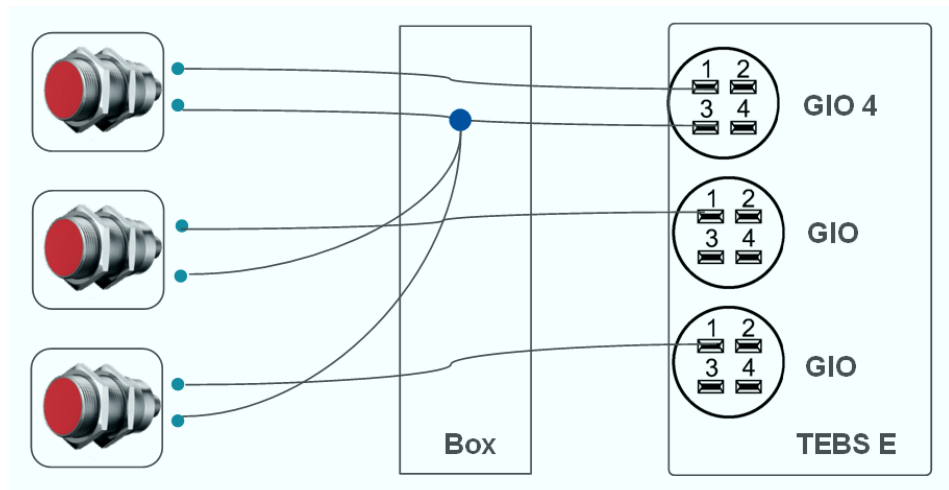

## Parameter setting

This function is activated and configured in the TEBS E diagnostic software in *tab 8, General Functions*.

Which GIO slots are to be used is defined in *tab 11, Connectors*.

## 6.18 Tilt warning (Roll Stability Adviser)

### Vehicle type

Trailers with a tipper body.

### Purpose

Monitoring the tilt angle of the vehicle.

### Function

A lateral acceleration sensor for the RSS function is integrated in each TEBS E Modulator. This lateral acceleration sensor also provides information on the inclination of the vehicle relative to the horizontal line. The TEBS E Modulator can monitor the vehicle's inclination.

If a frame inclination configured in the TEBS E diagnostic software ( $0^{\circ}$  -  $20^{\circ}$ ) is exceeded, a warning can be sent to the driver by the ECU and displayed on the SmartBoard or indicated by a horn / rotary beacon.

The warning threshold always depends on the specific vehicle and must be defined by the vehicle manufacturer.

---

**!** The driver must be instructed to interrupt actions such as tipping the dumping body immediately if he receives a warning.

The "Tilt warning" function is for assistance only and does not release the driver from his obligation to monitor the vehicle himself.

---

#### TEBS E4

The tipper body status can be monitored to ensure that the function is only active while the tipper body is raised.

On request, a warning is only output when a mechanical switch is used and this switch is closed (the lowered tipper body opens the switch).

If a proximity switch is used, this switch must be opened for an output of the warning to occur. This functional extension is only available with the TEBS E Premium Modulator.

Apart from the SmartBoard or the warning lamp, the warning lamp shared by several functions or the buzzer are also available for an output of the warning.

A tilt warning can also be outputted during the TEBS E stand-by time.

---

## Components

PART NUMBER	FIGURE	DESCRIPTION
Not part of WABCO's scope of supply		Horn / Rotary beacon
446 192 11X 0		SmartBoard (optional) <ul style="list-style-type: none"> <li>■ Cable for SmartBoard: 449 911 XXX 0</li> </ul>
446 122 080 0		Trailer Remote Control (optional) <ul style="list-style-type: none"> <li>■ Can only be used in combination with the electronic extension module and <b>from version TEBS E2 Premium</b>.</li> <li>■ Warnings are indicated in two warning stages.</li> <li>■ Scope of delivery: <ul style="list-style-type: none"> <li>■ Connection cable between the Trailer Remote Control and the fuse box in the truck</li> <li>■ Mounting bracket</li> </ul> </li> </ul>
894 450 000 0		Buzzer (optional)
Not part of WABCO's scope of supply		Warning lamp (optional)
Not part of WABCO's scope of supply		Proximity switch (optional)

## Parameter setting

This function is activated and configured in the TEBS E diagnostic software in *tab 8, General Functions*.

An additional warning lamp is controlled by means of a freely configurable digital function. Here, *Tilt warning active* is selected as the internal input signal.

Which GIO slots are to be used is defined in *tab 11, Connectors*.



## 6.19 Overload detection

### Vehicle type

Trailer vehicles with air suspension, e.g. with tipper body or silo.

### Purpose

Monitoring the load status during loading.

### Function

The load status of the trailer is determined by means of sensing the support bellows.

A lamp located on the outside of the vehicle signals the load status, to the driver of a wheel loader loading the trailer for example.

The lamp flashes with increasing frequency as the load increases. Longer phases of being lit are briefly interrupted each time.

When the permissible weight has been reached, the lamp is permanently lit.

In the event of overloading and the load increasing still further, the lamp flashes again with increasing frequency. However, now longer pauses are interrupted by brief flashes.

The lamp goes out with the start of driving and only comes on again with renewed loading.

The function can be deactivated by means of a switch.

The warning lamp is connected to a free GIO connection.

The lamp can either be used exclusively for this function or as a "shared warning lamp" for several functions. Information about this ▶ chapter "6.28 Freely configurable functions", page 130.

### Components

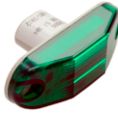
PART NUMBER	FIGURE	DESCRIPTION
446 105 523 2 (LED)		Green warning lamp <ul style="list-style-type: none"> <li>■ LED or bulb</li> <li>■ Installation on the trailer vehicle</li> <li>■ Universal cable: 449 535 XXX 0 (4-pole, open)</li> <li>■ Cable for green warning lamp: Superseal / open-ended 449 900 100 0</li> </ul>
Not part of WABCO's scope of supply		Switch (optional)

### Parameter setting

This function is activated and configured in the TEBS E diagnostic software in *tab 8, General Functions*. Two pressure values are entered for the tolerance range of the laden vehicle.

Which GIO slots are to be used is defined in *tab 11, Connectors*.

## 6.20 SafeStart

### Vehicle type

Dumper, roll-off container chassis, road tanker and bulk transporter.

### Purpose

Automatically brakes the truck-trailer combination during loading and unloading to prevent movement.

Examples: dumper with raised dumping body, road tanker with open tank cap, container lorry with unlocked container.

### Function

A sensor connected to the TEBS E Modulator detects whether a loading or unloading procedure is taking place. The diaphragm cylinders are braked using TEBS E.

SafeStart can be configured to match the respective vehicle type.

*Road tankers / roll-off containers:* The vehicle is braked using the service brake. The vehicle can only be moved again if the sensor detects that the loading or unloading procedure has been completed (e.g. by closing the control cabinet) and the brake pedal is pressed.

*Dumper:* Here the function allows a dumper to be driven at low speeds to facilitate the unloading procedure. From a speed of 18 km/h, 10 short braking actions warn the driver that the dumping body has not yet been lowered, for example. From a speed of 28 km/h the vehicle is brought to a standstill. When the vehicle is stationary ( $v = 0$  km/h), the brake releases after 20 seconds. The function is then deactivated and will only function again after restarting the ignition.

SafeStart can be used in combination with the electronic parking brake and/or the immobilizer. In this case, SafeStart would brake the spring brake cylinders with the immobilizer and electronic parking brake components.

### Installation instructions

---

**!** The vehicle manufacturer is responsible for proper positioning and installation of the sensor on the vehicle so that the TEBS E Modulator reliably recognises the loading or unloading function.

---

## Components

Extract from schematic diagram 841 802 274 0

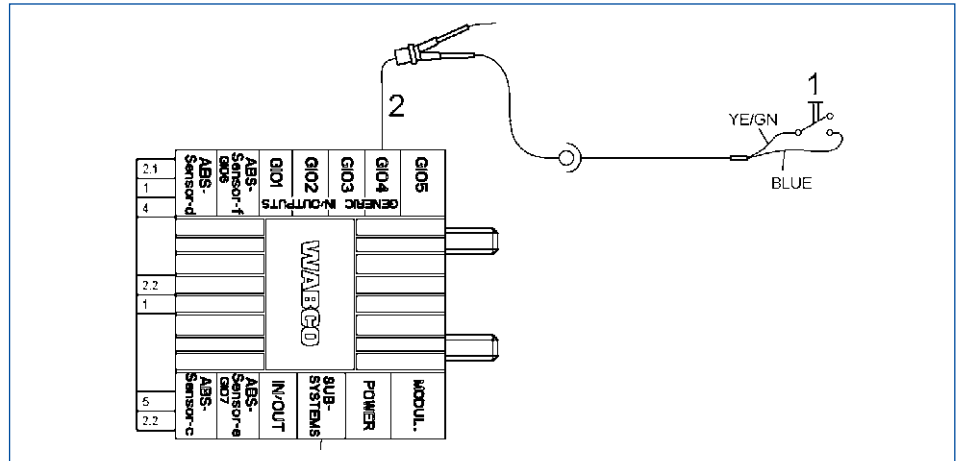

### LEGEND

<b>YE</b>	Yellow	<b>GN</b>	Green	<b>BL</b>	Blue
-----------	--------	-----------	-------	-----------	------

ITEM	PART NUMBER	FIGURE	DESCRIPTION
1	Not part of WABCO's scope of supply		Proximity switch (tested and recommended by WABCO): <ul style="list-style-type: none"> <li>■ Telemecanique XS7C1A1DAM8</li> <li>■ Schönbuch Electronic IO25CT 302408</li> <li>■ Balluff BES M30MF-USC15B-BP03</li> </ul>
	Alternatives:		
	441 044 101 0 441 044 102 0		Pressure sensor
	Not WABCO Scope of delivery		Mechanical (roller) switch
2	449 629 XXX 0		GIO Y-distributor

## Parameter setting

This function is configured in the TEBS E diagnostic software in *tab 6, Braking Functions*.

Which GIO slots are to be used is defined in *tab 11, Connectors*.

If SafeStart is to act on the spring brakes with a pulse-controlled lifting axle valve, the vehicle type *Road tanker* must be selected for the SafeStart function in *tab 6, Braking functions*.

## 6.21 Electronic parking brake (from version TEBS E4)

### Vehicle type

All trailer vehicles with additional power supply via 24N.

Exception: Special vehicles with external desired-pressure sensor on the CAN router / repeater.

### Purpose

- Prevents the trailer vehicle from rolling away if the pneumatic lines are connected in the wrong order when they are coupled to the towing vehicle.
- Protection against the vehicle combination rolling away if the park brake of the towing vehicle is not applied while the pneumatic lines are coupled.
- Protection against the parked trailer rolling away in the event of accidental or unauthorised actuation of the release valves on the PREV.
- Prevents the vehicle from being driven without an ISO 7638 plug connection.

### Function

TEBS E detects the uncoupled state. With the help of a pulse-controlled lifting axle valve and the spring-returned valve, the spring brake cylinders are activated when the trailer is parked and are only released again when all connections are plugged in and pressure is detected on the yellow coupling head.

To enable vehicle movement, the pulse-controlled valve is overridden by the spring-returned valve (on the venting connection of the lifting axle valve) during coupling. The vehicle can only be moved if the ABS connector is plugged in or the function has been deactivated via SmartBoard or a button or switch.

**Warning indicator / warning lamp:** The warning lamp flashes after the ignition is turned on while the electronic parking brake is still blocking the wheels.

**Operation:** The function operates automatically. In cases where TEBS E cannot detect the docking action, briefly tapping the brake pedal will suffice to release the trailer vehicle.

**Manoeuvring the vehicle without docking an electrical connection:** It is possible to temporarily deactivate the electronic parking brake function by means of a switch/button or the SmartBoard to allow the trailer to be transported onto a ferry at a later stage, for example. The electronic parking brake must be deactivated before the ignition is turned off and the trailer vehicle is uncoupled.

- **Deactivation by means of a switch on the GIO port against ground:** Opening the switching contact prevents activation of the electronic parking brake. Closing the switch reactivates the electronic parking brake.
- **Deactivation by means of a switch on a GIO port against Plus:** Closing the switching contact prevents activation of the electronic parking brake. Opening the switch reactivates the electronic parking brake.
- **Deactivation by means of a button on the GIO port against ground:** Pressing the button for a longer period prevents activation of the electronic parking brake for the next docking procedure. Briefly pressing the button reactivates the electronic parking brake.
- **SmartBoard:** The activity of the electronic parking brake can be switched off for the next docking procedure or permanently provided the Parameter setting permit this.

**Emergency function for releasing the electronic parking brake (24N is plugged in, ISO 7638 is not):** Applying the service brake for a longer period with a pressure greater than 4 bar releases the parking brake. The stop light must remain switched on for the vehicle to be moved.



## Combination with other functions

The electronic parking brake can be combined with SafeStart and/or the immobilizer using the same components.

## Components

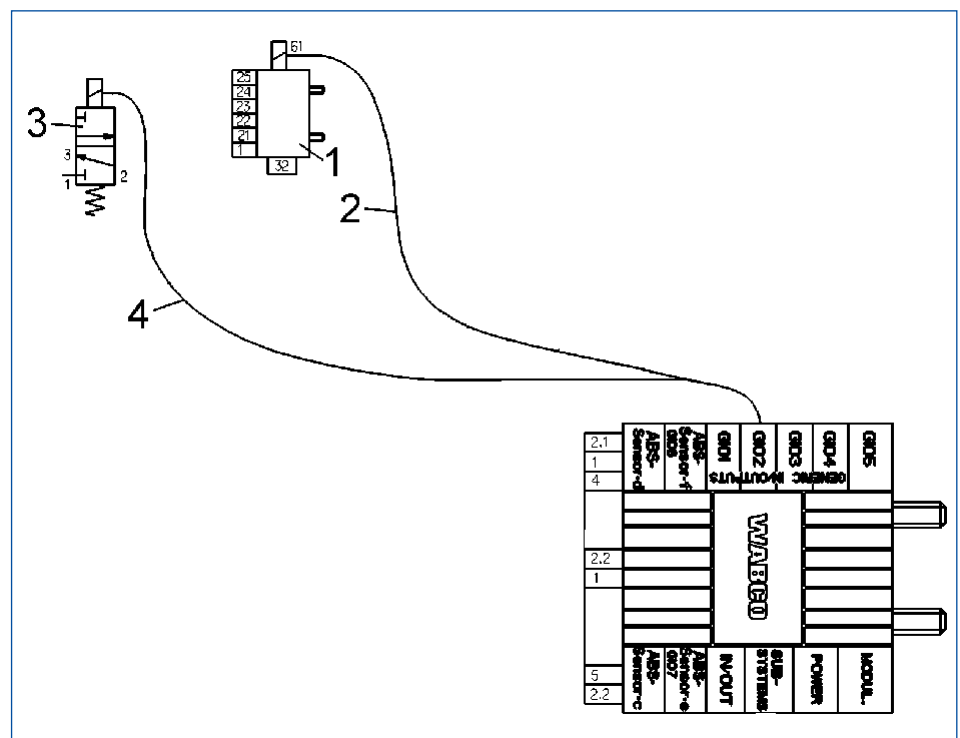
Extract from schematic diagram 841 701 264 0



ITEM	PART NUMBER	FIGURE	DESCRIPTION
1	463 084 100 0		LACV-IC
2	449 445 XXX 0		Cable for lifting axle valve
3	472 170 606 0		3/2 solenoid valve
4	449 443 XXX 0		Cable for 3/2 solenoid valve

ITEM	PART NUMBER	FIGURE	DESCRIPTION
	Not part of WABCO's scope of supply		Switch or button on a GIO port (optional)

## Parameter setting

This function is activated and configured in the TEBS E diagnostic software in *tab 6, Braking Functions*.

Which GIO slots are to be used is defined in *tab 11, Connectors*.

## 6.22 Relaxation function (Bounce Control)

### Vehicle type

All trailers.

### Purpose

The multi-axle combination is subjected to strain when the semitrailer is loaded and unloaded while the complete vehicle train is braked. When the park brake is released, following unloading for example, the vehicle body can jump up abruptly because the air suspension lifts the vehicle immediately with the air-spring bellows still full and the load now absent. The relaxation function prevents the body from jumping up in this manner and thereby protects the load.

### Function

The function can be activated with a button or the SmartBoard.

The tension on the applied brakes is released by actuating the brake cylinder from the modulator. The brakes are released side by side (for semitrailers/ central axle trailers) or by axle by axle (for drawbar trailers) for this purpose. Deceleration of the vehicle is always over 18 % during this process because the brake cylinders are released alternately.

### Components

One of the following components is required to activate the function:

PART NUMBER	FIGURE	DESCRIPTION
446 192 11X 0		SmartBoard (optional) <ul style="list-style-type: none"> <li>■ Cable for SmartBoard: 449 911 XXX 0</li> </ul>
Not part of WABCO's scope of supply		Switch (optional) <ul style="list-style-type: none"> <li>■ Universal cable (optional): 449 535 XXX 0</li> </ul>

## Parameter setting

This function is activated in the TEBS E diagnostic software in *tab 6, Braking Functions*.

Which GIO slots are to be used is defined in *tab 11, Connectors*.

## 6.23 Steering axle lock

---

! Observe the guidelines for safe operation of steering axles.

■ The steering axle must be disconnected when locked.

---

## Vehicle type

Semitrailer with steering axle.

## Purpose

TEBS E can be used to control a steering axle by means of a cylinder to lock it in a straight-ahead position dependent on the speed, or additionally when reversing is detected.

The steering axle can be locked dependent on speed to ensure steady straight-ahead driving at high speeds. In addition, and for logical reasons, the steering axle is locked when reversing by monitoring the reversing lamp.

## Function

A solenoid valve is used to control the cylinder. The TEBS E Modulator controls the solenoid valve depending on the speed set in the parameters.

When travelling at normal speed (e.g. > 30 km/h), the steering axle is locked by the GIO function. If the speed specified in the parameters is exceeded, the GIO function releases the lock and the steering axle turns when cornering.

When stationary ( $v < 1.8$  km/h), the steering axle is locked again. The lock is maintained by engaging reverse gear (when reversing lamps are active) to prevent steering while reversing. If the vehicle moves forward again, the lock is maintained up to a speed defined in the parameters (> 1.8 km/h) when it is released and only applied again when a second defined speed is exceeded.

## Connecting the components

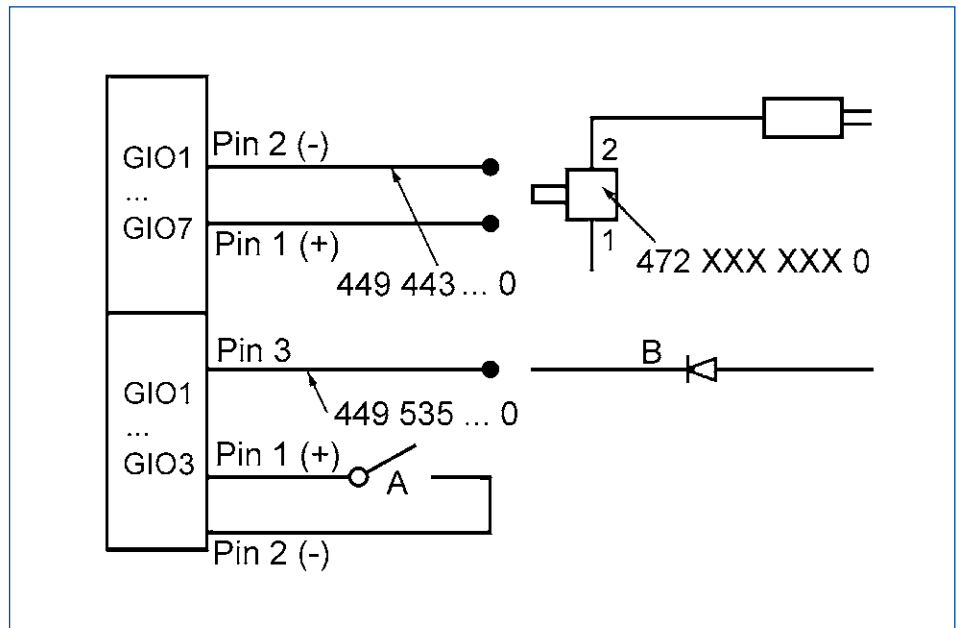

### LEGEND

<b>A</b>	Optional switch for locking the steering axle	<b>B</b>	(+) signal from the reversing lamps The diode is no longer required from TEBS E4.
----------	---	----------	--

## Parameter setting

This function is activated in the TEBS E diagnostic software in *tab 8, General Functions*.

Which GIO slots are to be used is defined in *tab 11, Connectors*.

The steering axle can also be locked when the lifting axle is raised with the parameter *With raised lifting axle*.

Reverse detection can occur via electronic extension module (parameter *Reverse detection via electronic extension module*) if combined with a TailGUARD™ system ▶ chapter "7.1.1 TailGUARD™ functions", page 134. The reversing lamp does not have to be additionally connected to TEBS E.

## 6.24 Forklift control

### Vehicle type

Mainly for central axle trailers with forklift transport.

### Purpose

Optimising the support load, if the forklift is absent as a counterbalance.



## Function

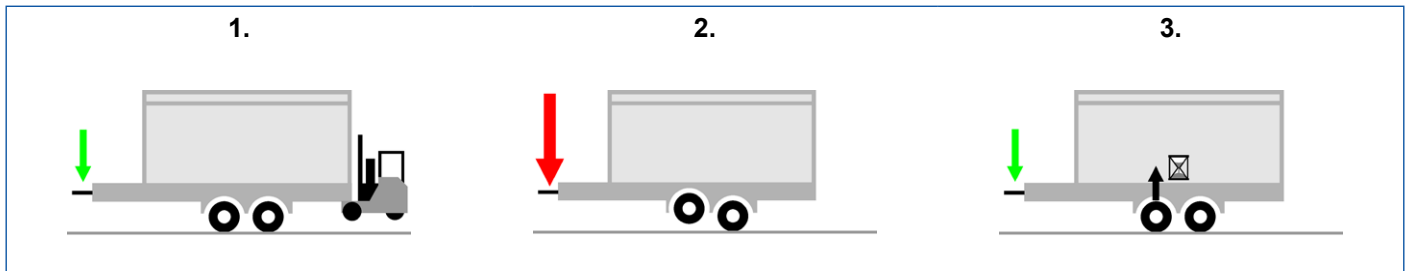

Central axle trailers with an attached forklift are normally constructed so that, when the forklift is attached, the weight distribution is balanced between the front and back. A correspondingly broadly spread support load works as a counterload to the additional weight of the forklift (Fig. 1).

If this type of central axle trailer is travelling under a partial load, but without the forklift and with a raised lifting axle, the excessive weight of the construction can lead to extra support load on the trailer coupling side since the counterweight of the forklift is missing (Fig. 2).

With the function "Forklift control", lifting the lifting axle can be delayed with a partially loaded vehicle without forklift so that the support load is not too great on the coupling.

The axle that remains on the ground causes the wheelbase to remain short so that the complete support load is not on the coupling, because the back of the trailer, even without the forklift, is a more efficient counterbalance (Fig. 3).

### Function prerequisites

Proximity switch or mechanical switch (roller switch) for detecting the attached forklift.

The load on the trailer should be distributed evenly to prevent any additional influence by the support load.

#### TEBS E4

In the case of central axle trailers with 2 lifting axles, TEBS E automatically detects which axle is lifted and uses the axle on the ground as the main axle.

Trailer EBS E uses a proximity switch or a mechanical (roller) switch to detect whether a forklift is docked on the vehicle and automatically switches between the two lifting axle characteristic curves:

- a) Characteristic curve for controlling the lifting axle with attached forklift
- b) Characteristic curve for controlling the lifting axle with unattached forklift

Both characteristics are to be defined by the vehicle manufacturer himself relative to the desired load-dependent time for lifting the lifting axle.

### Forklift control with OptiLoad™

Forklift control can also be demonstrated via the "OptiLoad™" function. In this case, the front axle is fitted with OptiLoad™ instead of the rear axle. This means that the maximum possible wheel base is always adjusted to thus preventing a negative support load generally.

If the forklift is no longer attached, the function must be deactivated. The presence of the forklift can then be sensed using a roller switch and the "Forced Lowering" function thereby controlled.

## Components

Extract from schematic diagram 841 802 292 0

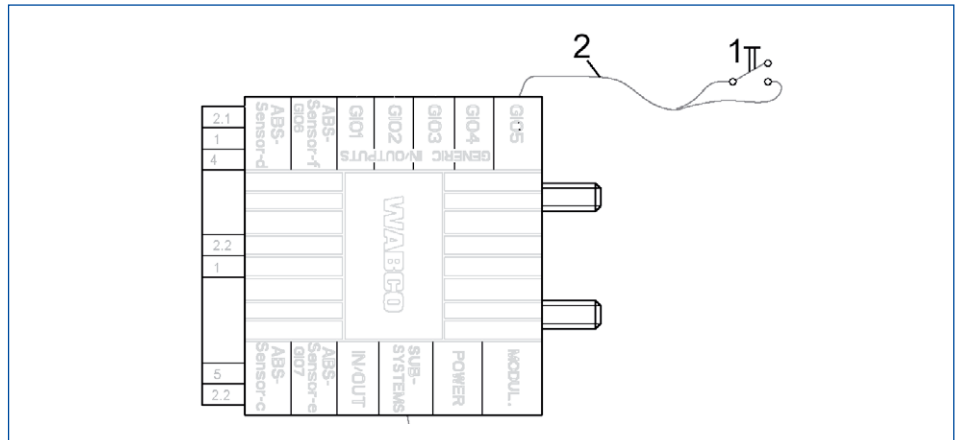

ITEM	PART NUMBER	DESCRIPTION
1	Not part of WABCO's scope of supply	Proximity switch (tested and recommended by WABCO): <ul style="list-style-type: none"> <li>■ Telemecanique XS7C1A1DAM8</li> <li>■ Schönbuch Electronic IO25CT 302408</li> <li>■ Balluff BES M30MF-USC15B-BP03</li> </ul>
2	449 535 XXX 0	Universal cable <ul style="list-style-type: none"> <li>■ 4-pin, open</li> </ul>
	Not WABCO Scope of delivery	Mechanical (roller) switch

## Parameter setting

This function is activated in the TEBS E diagnostic software in *tab 5, Lifting Axle Control*.

Which GIO slots are to be used is defined in *tab 11, Connectors*.

## 6.25 Brake release function

### Vehicle type

For example, car transporters or log trailers for timber transporters.

### Purpose

Release the service brake of the trailer when stationary.

Application: Supporting the hydraulic extension of a trailer vehicle while the towing vehicle is stationary.

TEBS E2.5

Releasing the service brake at low speed.

Application: Loading or unloading an unladen log trailer

## Function

The function is activated with an external button or via the SmartBoard.

When releasing the push-button or the respective button of the SmartBoard, the brake is immediately filled with air again and the trailer is braked.

### Requirements for the brake release function

- The parking brake in the towing vehicle is actuated.
- The pressure on the yellow coupling head must be greater than 6.5 bar. The brake release function will be aborted if the pressure on the yellow coupling head drops.
- Standard brake release function: The brake release function will be aborted at a speed  $v > 1.8$  km/h.
- Advanced brake release function: The brake release function will be aborted at a speed  $v > 10$  km/h.

! The report "ID\_EB158.0 – Brake release and relaxation function" ▶ chapter "5.3 Expert reports and standards", page 24, applies to this function (not valid for the "Advanced brake release function").

## Components

One of the following components is required to activate the function:

PART NUMBER	FIGURE	DESCRIPTION
446 192 11X 0		SmartBoard <ul style="list-style-type: none"> <li>■ Cable for SmartBoard: 449 911 XXX 0</li> </ul>
Not part of WABCO's scope of supply		Push-button (optional)

## Parameter setting

This function is activated in the TEBS E diagnostic software in *tab 6, Braking Functions*.

Which GIO slots are to be used is defined in *tab 11, Connectors*.

## 6.26 Emergency stop light (Emergency Brake Alert)

### Vehicle type

All trailers.

### Purpose

If the vehicle is in a hazardous situation and needs to brake abruptly, emergency braking can be indicated by making the trailer stop lights flash.

### Function

In TEBS E a separate GIO output is provided for this to which the stop light is connected via a relay. The relay does so by interrupting the stop light using a specific preset frequency.

On some towing vehicles, the function for the trailer stop lighting is monitored so that a basic load exists in relay operation in both switch states (stop light or resistance) so that no error is detected from the towing vehicle.

For compatibility with the towing vehicle's stop light error recognition process, WABCO recommends building in a resistance of 100 Ohm parallel to the relay.

The GIO output is allowed to be loaded to maximum 1.5 A.

## Activation

The function is automatically activated by the TEBS E Modulator depending on the following situations:

- If the vehicle deceleration is greater than 0.4 g in an emergency braking procedure.
- If an ABS control procedure occurs at a speed of > 50 km/h.

The function is ended again if the vehicle deceleration is under the value 0.25 g or the ABS control is deactivated again.

### TEBS E4

The speed threshold for the emergency stop light can be reduced by means of a parameter and can thus also be used for agricultural vehicles.

## Components

The following components can be used for indication:

### Extract from schematic diagram 841 802 291 0

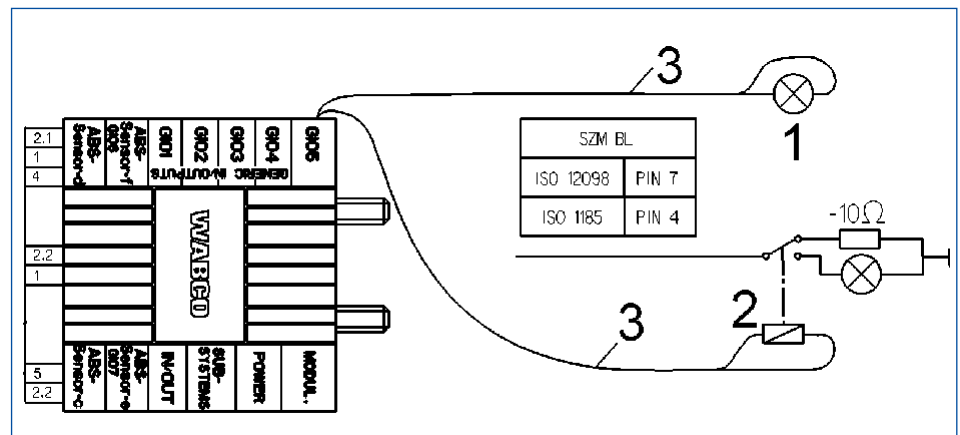

ITEM	PART NUMBER	DESCRIPTION
1	Not part of WABCO's scope of supply	Stop light <ul style="list-style-type: none"> <li>■ LED or bulb</li> <li>■ max. 24 V</li> <li>■ 1.5 A</li> </ul>
2	Not part of WABCO's scope of supply	Relay <ul style="list-style-type: none"> <li>■ Resistor required</li> </ul>
3	449 535 XXX 0	Universal cable <ul style="list-style-type: none"> <li>■ 4-pin, open</li> </ul>

## Parameter setting

This function is activated and configured in the TEBS E diagnostic software in *tab 8, General Functions*.

Which GIO slots are to be used is defined in *tab 11, Connectors*.

## 6.27 Immobilizer

### Vehicle type

All trailers.

### Purpose

Immobilizer for reducing the risk of theft.

The function can also be used as an "electric parking brake". This secures the parked vehicle against rolling in the event that unauthorised persons intentionally or accidentally actuate the red button on the PREV.

### Function

Using an integrated pulse-controlled lifting axle valve, the wheels of a parked vehicle can be locked via the Tristop™ cylinder.

The immobilizer can be activated or deactivated by entering a special PIN using the SmartBoard or Trailer Remote Control.

If a vehicle is moved while the immobilizer is activated or the system is manipulated, the TEBS E Modulator can output an alarm signal (24 V voltage) to a connected optional output device (warning lamp, horn).

#### **Emergency release function or emergency unlocking mechanism**

The emergency release function can be used to deactivate the immobilizer without entering the user PIN to allow moving the vehicle, in critical situations for example.

- You can set parameters for an emergency release function.

The emergency release function is activated via the SmartBoard and releases the vehicle for a defined period of time.

#### **Example of situation process "Vehicle secured with immobilizer"**

Trailer with towing vehicle must be moved from a critical road situation. PIN is not available.

- Activate the emergency release function using the SmartBoard or Trailer Remote Control.
- Move the vehicle to a safe location.
  - ⇒ As soon as the vehicle is at a standstill for 60 seconds, the immobilizer is activated again.
  - ⇒ If necessary, this process can be repeated up to 3 times. Then the emergency release function is locked.
  - ⇒ After activating the immobilizer with PIN and PUK, the emergency release function is available again.

## TEBS E2

### Warning indicator / warning lamp

From version TEBS E2, the driver is notified of the immobilizer status by the warning indicator / warning lamp (yellow). If the immobilizer is inactive, the warning indicator / warning lamp flashes eight times after switching the ignition on.

From TEBS E2, you can use parameter *Unlock only with engaged parking brake* to set whether the immobilizer should only be able to be unlocked with the parking brake applied.

### Logging the events

Specific activities relating to the immobilizer are stored in the operating data recorder (ODR) as event entries for logging and evaluation ▶ chapter "5.10.7 Operating data record (ODR)", page 56. This data can be viewed by insurance agencies or fleet managers for example.

An ODR event is generated for the following events:

- Immobilizer status changes
- Incorrect PIN entered
- Moving of vehicle despite immobilizer
- Emergency release function operated

### Power supply



To activate/deactivate the immobilizer, the trailer must be supplied with power. This can be achieved in two ways.

- Switch on ignition (supply via terminal 15)
- ECU stand-by time (supply via terminal 30): A time parameter must be defined in the Parameter setting for this purpose.

# GIO functions

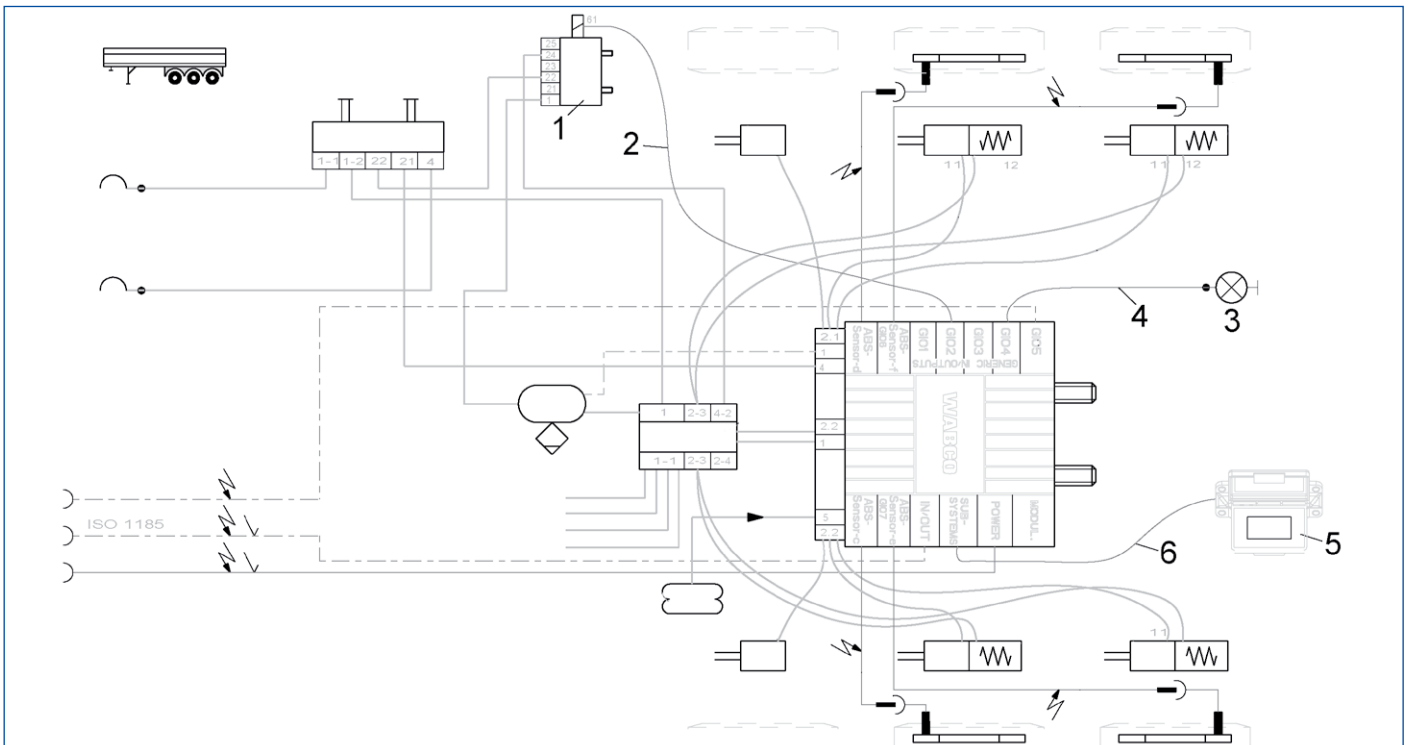
## Connecting the components – excerpt from schematic diagram 841 701 227 0 for three-axle semitrailers



ITEM	PART NUMBER	FIGURE	DESCRIPTION
1	463 084 100 0		Lifting axle valve (LACV-IC) <ul style="list-style-type: none"> <li>Can also be connected to GIO1, GIO2 or GIO3.</li> </ul>
2	449 445 XXX 0		Cable for lifting axle valve
The following components can be used for indication and operation:			
3	Not part of WABCO's scope of supply		Warning lamp / warning horn (optional)
4	449 535 XXX 0		Universal cable for alarm signal (optional) <ul style="list-style-type: none"> <li>4-pin, open</li> </ul>
5	446 192 11X 0		SmartBoard
6	449 911 XXX 0		Cable for SmartBoard (optional)

ITEM	PART NUMBER	FIGURE	DESCRIPTION
	446 122 080 0		Trailer Remote Control (optional) <ul style="list-style-type: none"> <li>■ Can only be used in combination with the electronic extension module and <b>from version TEBS E2 Premium</b>.</li> <li>■ Scope of delivery:               <ul style="list-style-type: none"> <li>■ Connection cable between the Trailer Remote Control and the fuse box in the truck</li> <li>■ Mounting bracket</li> </ul> </li> </ul>

### TEBS E1.5

In the TEBS E1.5 Modulator, the immobilizer function cannot be combined with the ECAS valve 472 905 114 0 for electronic air suspension and controlling the OptiTurn™ or OptiLoad™ functions. The optional output devices can be connected to GIO1 to GIO17. The supply voltage output is 24 V.

The immobilizer function can be tested by means of the EOL test or the *Actuation* menu. Activating the function with the PUK key is not required in this case.

### TEBS E2

With version TEBS E2 or higher, additional GIO interfaces can be used to install the most advanced features of the immobilizer in combination with the OptiLoad™ and OptiTurn™ functions:

Lifting axle valve (LACV-IC) 463 084 100 0 with an ECAS solenoid valve 472 905 114 0 or 2x lifting axle valve (LACV-IC) 463 084 100 0 with the ECAS solenoid valve 472 880 030 0.

## Installation

Information on installation ▶ chapter "8.7 Installing the immobilizer components", page 160.

## Parameter setting

This is activated and configured in the TEBS E diagnostic software in *tab 8, Braking Functions*.

Which GIO slots are to be used is defined in *tab 11, Connectors*.

## Unlocking and activating the immobilizer

The serial number of the TEBS E Modulator and the PUK (Personal Unblocking Key) are required for initial activation after setting the parameters.

### PUK

One PUK is necessary for each unlocking/vehicle.

The document "PUK Access Code 813 000 049 3" together with the individual voucher code (1x per vehicle) is needed for this purpose.



### Document "Trailer Immobilizer – PUK Access Code"

- Open the WABCO INFORM online product catalogue:  
<http://inform.wabco-auto.com>
- Search for the document by entering the number 813 000 049 3.



## Purpose of the PUK

- Unlocking the immobilizer function in the TEBS E Modulator.
- Defining / changing the user PIN.
- Definition of a new PIN after incorrect entry.

! The PUK is reserved for the vehicle owner only. Handle the PUK with care and protect it from unauthorised access by others. Keep the PUK in a safe place. WABCO will not be held responsible for the loss or misuse of the PUK.

## Serial number of the TEBS E Modulator

The 13 digit serial number (S/N) including the check digit (last position) can be displayed as follows:

- SmartBoard (menu *Tools, System Info, System*)
- EOL log

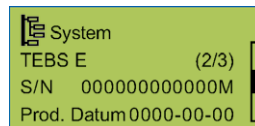

- System label (*Print system label*)

## Activation via the SmartBoard and definition/change of PIN

- Connect the SmartBoard to the TEBS E Modulator.
- Open the *Tools, Settings, Enter new PIN, with PUK* menu in the SmartBoard
- Enter the PUK via the SmartBoard.
- Define a PIN and enter it via the SmartBoard.
- Re-enter PIN to confirm.
- ⇒ Upon successful activation a confirmation appears on the display.

## Activation via the TEBS E diagnostic software

- Connect the TEBS E Modulator to the TEBS E diagnostic software.
- Open the TEBS E diagnostic software.
- Click *Tools/Immobilizer*.
- Click *Change PIN with Super PIN*.
- Enter the PUK in the *Super PIN* field.
- Define a PIN and enter it in the *Enter new PIN* field.
- Confirm the PIN by re-entering it in the *Re-enter new PIN* field.
- ⇒ Following successful activation a confirmation window appears.

## Operating options with the SmartBoard / Trailer Remote Control

Information on operation ▶ chapter "10.7 Operating the Immobilizer", page 193.

OPERATING OPTIONS	SMARTBOARD	TRAILER REMOTE CONTROL
Deactivation / activation by PIN entry	✓	✓
Deactivation / activation with stored PIN	✗	✓ Must be unblocked with Parameter setting.
Status information	✓	✓
Driver warning	✓ With ISO 7638 / pin 5	✓ LED signal and acoustic warning, identical with status information
Emergency release function / emergency unlock	✓	✓
Changing the PIN	✓	✗
Reactivation with PUK	✓	✗
Activation with PUK	✓	✗

## 6.28 Freely configurable functions

### Freely configurable digital function

Free programming by the manufacturer of a GIO digital input or output depending on speeds and times.

TEBS E4

As of TEBS E4 many items of TEBS E-internal information can be evaluated to generate signals to a jointly used buzzer or jointly used lamp.

### Freely configurable analogue function

Free programming by the manufacturer of a GIO analogue input or output depending on speeds and times.

With both analogue and digital functions an Event (for example) can be stored or a GIO output switched as a function of a switch signal and the vehicle speed ▶ chapter "5.10.7 Operating data record (ODR)", page 56.

### Control of freely configurable functions via the Trailer Remote Control

In combination with the electronic extension module the functions can also be controlled via the Trailer Remote Control. (The signals from the Trailer Remote

Control are linked to the input signals of both functions by means of an "or" function.)

A pushbutton on the Trailer Remote Control can also be used as an input signal instead of a switch of the freely configurable analogue or digital function.

Possible applications are, for example, controlling an electric walking floor or an electric tarpaulin from the towing vehicle.

## Freely configurable functions

In addition to the analogue and digital functions it is also possible to store what are known as GIO function modules in TEBS E via the diagnostics. These are capable of processing internal signals (CAN bus, internal pressures, speeds) as well as external input variables (such as switch, pressure sensor, SmartBoard).

Output signals as well as internal functions such as saving events to the event recorder can be controlled according GIO function module programming. The function can therefore be used to implement small customer-specific applications.

## Parameter setting

The function is loaded in TEBS E using an \*.FCF or \*.ECU file.

! Please speak with your WABCO partner about parameters for the freely configurable functions. Only files created by WABCO can be loaded into the ECU.



A list of previously developed functions is available at <http://www.wabco.info/i/48>

---

## 7 External systems

### 7.1 Electronic extension module

#### Application

TEBS E Modulators (Premium) from version E2  
TailGUARD™: TEBS E Standard from Version E5

#### Purpose

The electronic extension module 446 122 071 0 in conjunction with a TEBS E Premium Modulator offers the following extended functions:

- TailGUARD™
- Connection to ISO 12098

The electronic extension module 446 122 070 0 in conjunction with a TEBS E Premium Modulator allows the following additional functions to be used:

- ECAS 2-point control
- Battery supply and battery charging
- Terminal extensions
- Control of the trailer from the driver's cabin by means of the Trailer Remote Control

#### Function

The electronic extension module is supplied via ISO 7638 and TEBS E. Communication between EBS and the electronic extension module is made via CAN. The connection to ISO 12098 is possible via a junction box; control of clearance lights is realised via relay.

Communication between the electronic extension module and LIN ultrasonic sensors (for TailGUARD™ functions) is realised via LIN-BUS. The data transfer via the Trailer Remote Control and EBS or the electronic extension module is done via Power Line Communication (PLC) – transfer of data via mains supply. ECE R13 is fulfilled for all applications.

## External systems

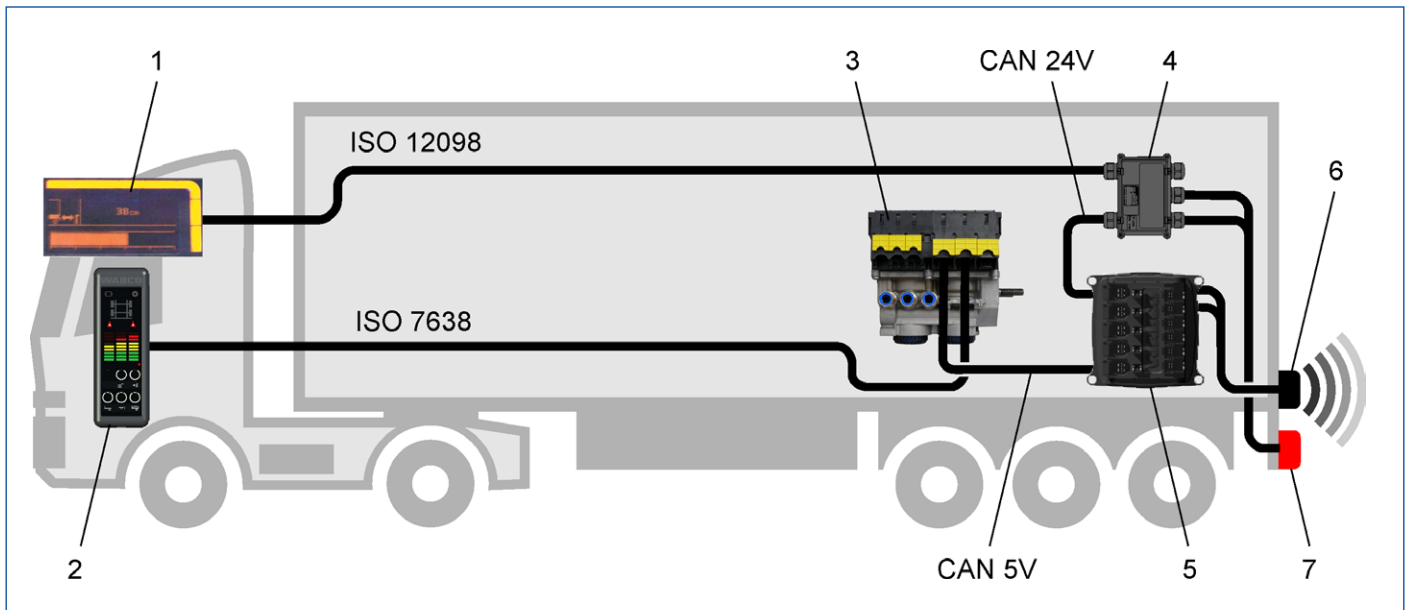

ITEM	DESIGNATION
1	Dashboard
2	Trailer Remote Control
3	TEBS E Modulator ( <b>Premium or Standard from version TEBS E5</b> )
4	Junction box
5	Electronic extension module
6	Ultrasonic sensor
7	Marker light

## 7.1.1 TailGUARD™ functions

### Vehicle type

All trailers.

### Purpose

Detecting objects out of the driver's field of vision behind the trailer with ultrasonic sensors.

Benefits: Avoiding cost-intensive damage on vehicle, ramp and loading.

! On towing vehicles with automatic transmissions, the accelerator pedal must be released on time, otherwise passing the stopping point may occur if the towing vehicle increases engine power when braking with TailGUARD™.

The TailGUARD™ system does not relieve the driver of the responsibility for checking the rear when reversing. A guide directing the driver is still essential.

Extreme weather conditions e.g. heavy rain or snowfall, can lead to the restricted functionality. Objects with very soft surfaces cannot be detected under all circumstances. WABCO cannot hold liable for an accident that is caused despite of using this system; this is a support system only.

If a ramp is approached at an oblique angle, the sensors may be unable to detect the ramp.

### Function

TailGUARD™ is activated by engaging the reverse gear. Activation will cause the clearance lights on the trailer to be actuated via the electronic extension module and flash. The flashing frequency is increased the closer the vehicle is to the object.

If the parameterised stopping distance is falling below, the vehicle will be braked for 3 seconds and then brake will be released. The stopping distance can be set via diagnosis (between 30 and 100 cm for TailGUARDlight™; between 50 and 100 cm with TailGUARD™, TailGUARD<sup>Roof</sup>™ and TailGUARDMAX™).

If TailGUARD™ initiates automatic braking, at the same time a demand for actuating the stop lights will be sent via ISO 7638 CAN interface to the towing vehicle. New trailer vehicles support this function and activate the stop light.

During this time the clearance lights are switched on permanently. The braking pressure of the Trailer EBS E is defined by the electronic extension module depending on vehicle speed and the distance to the object measured by the ultrasonic sensors.

If the speed remains below 9 km/h, the brake is activated only for the final stop of the vehicle in front of the ramp.











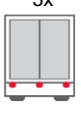
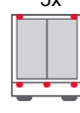

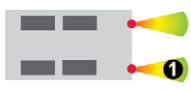
If the vehicle approaches the ramp at a speed below 9 km/h, the system triggers short brake pulses to alert the driver of excessive speed and regulates the speed down to 9 km/h. If the warning brake actions are ignored and the speed continues to increase, the system is switched off at 12 km/h.

After automatic braking the driver can perform an automatic reset. The distance information will be sent to the towing vehicle by means of the electronic extension module and TEBS E via PLC (Power Line Communication) and can be displayed via the Trailer Remote Control for the driver.

Furthermore, the communication occurs via ISO 12098 CAN interface "Towing vehicle" (actuation of the clearance lights).

**Silent mode:** If a buzzer is connected, it can be deactivated temporarily by engaging the reverse gear twice within 3 seconds, e.g. when making deliveries in residential areas.

## System configurations

FEATURES	TailGUARDlight™	TailGUARD™	TailGUARD <sup>Roof</sup> ™	TailGUARDMAX™
Typical logistical environment	Large loading ramps with equal shape or even walls; no objects or people behind the trailer vehicle.	Loading ramps and large objects, such as palettes, vehicles and posts of metal or wood that vary in shape and size and are unknown to the driver.	Areas with restricted heights: e.g. warehouses, loading gates, trees and roof constructions.	Areas with small and / or moving objects: e.g. forklift loading, street signs, shops, residential areas. Tested to ISO 12155.
Number of ultrasonic sensors (red dot = sensor)	2x 	3x 	5x 	6x 
Area covered by sensors (View from top of vehicle)	Limited 	Complete rear of the vehicle is covered by sensors. 1 and 2 indicate objects behind the vehicle. 		
Area covered by sensors (side view)				
Each bar represents a distance of 50 cm. Red: 0 to 150 cm Yellow: 150 to 300 cm Green: 300 to 450 cm In close proximity (red LEDs) the following also applies: Each LED has 2 states, constant and flashing. This indicates the distance with a precision of 25 cm.		 Indication on the Trailer Remote Control	 Indication Floor height  Indication Roof height	 Indication on the Trailer Remote Control
	The level with nearest object will be displayed.			
Sensitivity of sensors	Only objects directly behind the left or right sensor are detected and displayed. Objects located between the sensors are not detected.	Big moving objects are detected independent of one another and displayed.	Objects at ground level and roof level are detected and displayed, independent of one another.	Small moving objects are detected independent of one another and displayed.
Distance display (Mode)	ISO 12155	ISO 12155 or WABCO standard	ISO 12155 or WABCO Standard	ISO 12155
Position of the sensors as shown in the drawing	841 802 280 0	841 802 281 0 841 802 285 0	841 802 283 0 841 802 284 0	841 802 282 0

## TailGUARDlight™ – ramp approach support

This system only measures the distance to a ramp with two ultrasonic sensors. Not the entire area behind the vehicle is monitored.

TailGUARDlight™ supports the driver at reversing to loading ramps. Here in interaction with Trailer EBS, the trailer vehicle brakes automatically before reaching the load ramp in order to prevent damages to the vehicle and ramp.

The braking pressure is defined depending on vehicle speed and the distance to the object measured by the ultrasonic sensors.

If the speed remains below 9 km/h, the brake is activated only for the final stop of the vehicle in front of the ramp. If the vehicle moves backward at 9 km/h or more, the system triggers short brake impulses to notify the driver of the excessive speed and reduces the speed.

To avoid damage while loading and unloading due to relative movements of the vehicle towards the ramp, a space between trailer and ramp is maintained. The minimum distance is 30 cm; WABCO recommendation: 50 cm.

With a Trailer Remote Control installation in a towing vehicle, the distance to the ramp is displayed with two rows of LEDs. At the same time, the distance to the ramp is indicated by a buzzer or the Trailer Remote Control emitting different frequencies.

If the angle between the ramp and the direction of vehicle movement is  $> 10^\circ$ , the ramp cannot be detected in all circumstances.

### TailGUARD™ – rear area monitoring (includes TailGUARD™, TailGUARD<sup>Roof</sup>™ and TailGUARDMAX™)

With this system, the entire area behind the vehicle is monitored with ultrasonic sensors.

WABCO recommends a minimum system of three sensors on the main level (TailGUARD™).

#### TEBS E2.5

From version TEBS E2.5, a new installation option for TailGUARD™ and TailGUARD<sup>Roof</sup>™ optimised the detection of protruding ramps.

To enable detection of roofs with TailGUARD<sup>Roof</sup>™ even where space is restricted, the upper external sensors can be mounted horizontally. A wide-range reverse monitoring system is not provided for the upper level with this installation variant.

Please note the descriptions of installation and start-up in this regard.

TailGUARD™ detects objects on the ground, such as light posts or other objects that are located in the pick-up area of the ultrasonic sensors (at the height of the ultrasonic sensors). TailGUARDMAX™ is tested according to ISO 12155. During the installation, the install dimensions must be maintained ▶ chapter "8.9 Installing the TailGUARD™ components", page 161.

### Form and positive recognition

The area behind the vehicle is monitored up to the vehicle width and a distance of max. 2.5 - 4 m back behind the vehicle.

If an object is located within the monitoring area of the sensors, the distance indicated as follows:

- Flashing clearance lights with varied frequencies
- Display on the LED bar in the optional Trailer Remote Control
- Changing tone frequency of the beeper in the Trailer Remote Control
- Optional, external buzzer (not included in WABCO scope of delivery)
- Optional, external signal lights (not WABCO supplied) for countries, in which flashing clearance lights are not allowed, such as Great Britain or Switzerland

If the ultrasonic sensors are raised to a height at which parts of a ramp are located, the system can also be used as ramp approach support.



An external acoustic signal transmitter can be connected to GIO14 / Pin 1 (electronic extension module). When using the Trailer Remote Control, the driver in the cab is notified by an acoustic signal as well as a visual indication of the position and the distance of detected objects.

## Acoustic and visual driver information

The changes in lamp and buzzer frequencies occur at distances of 3 m, 1.8 m and 0.7 m.

The buzzer is not to be used as the only distance output because it is not possible to clearly indicate a malfunction.

DISTANCE TO OBJECT	ACOUSTIC SIGNAL (BUZZER)	CLEARANCE LIGHTS	EXTERNAL LIGHTS	
			OPTION 1 (ACCORDING TO ISO): YELLOW / RED	OPTION 2: GREEN / MAGENTA
> 3 m	off	1 Hz	off	Green
3 m - 1.8 m	2 Hz	2 Hz	Yellow flashing	Green
1.8 m - 0.7 m	4 Hz	4 Hz	Red flashing	Green / Magenta External light
< 0.7 m – brakes automatically	6 Hz	6 Hz	Red permanently on	Magenta
< automatic (defined) braking distance	1 second on	permanently on	Red permanently on	Magenta
Component test after switching on ignition (only if $v < 1.8$ km/h)	0.5 seconds on	0.5 seconds on	0.5 seconds on	0.5 seconds on
System activated (reverse gear engaged)	0.5 seconds	0.5 seconds	0.5 seconds	0.5 seconds
Fault message if system is not active (only if $v < 1.8$ km/h)	off	off	off	off
Fault message if system is active (only if $v < 1.8$ km/h)	off	off	Yellow and red permanently on	off

### Activation

TailGUARD™ is activated by engaging the reverse gear. The activation causes the beeper and the yellow and red LED on the Trailer Remote Control to switch on briefly. The clearance lights on the trailer vehicle are also switched on by the TEBS E and they flash.

An indication of the distance to an object on the towing vehicle display is possible depending on the manufacturer.

### Deactivation

The function is deactivated by:



- Speed > 12 km/h and/or supply pressure lower than 4.5 bar
- Shut-off by the Trailer Remote Control
- Temporarily switch off with an external button on the GIO
- Engage reverse gear two times within 1-3 seconds
- Because of a fault (TEBS E cannot brake automatically in this case)

All deactivations are only effective until the reverse gear is engaged again. If the system is deactivated, the clearance lights or additional lights are not actuated. The acoustic signals are switched off and the Trailer Remote Control shows the respective system status on the display. Deactivating TailGUARD™ is stored as an event in the operating data recorder (ODR).

! Please note that the electronic ISO 7638 connection must be plugged in for operation of the TailGUARD™ function.

TailGUARD™ cannot be operated with a supply from 24N.

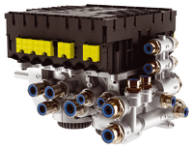
## Component overview for the TailGUARD™ configurations (WABCO recommendation)

COMPONENT / PART NUMBER	TailGUARDlight™	TailGUARD™	TailGUARDRoof™	TailGUARDMAX™
TEBS E Premium Modulator 480 102 06X 0 480 102 08X 0 From TEBS E5: Standard Modulator 480 102 03X 0 	1x	1x	1x	1x
Electronic extension module 446 122 070 0  446 122 071 0 (Basic)	1x	1x	1x	1x
LIN ultrasonic sensor 0° 446 122 401 0 (cable length 3 m) 	2x	1x	1x	2x
LIN ultrasonic sensor 15° 446 122 402 0 (preconfigured, right 3 m) 446 122 403 0 (cable length 0.3 m) 446 122 404 0 (preconfigured, left 3 m) 	-	2x	4x	4x

## External systems

COMPONENT / PART NUMBER	TailGUARDlight™	TailGUARD™	TailGUARD <sup>Roof</sup> ™	TailGUARDMAX™
Trailer Remote Control 446 122 080 0 	Optional	Optional	Optional	1x
Power cable for connection between TEBS E and electronic extension module 449 303 020 0	1x	1x	1x	1x
Cable for sensor 449 806 060 0	2x	2x	2x	2x
Splitter cable for sensors 894 600 024 0	–	1x	3x	4x
Buzzer 894 450 000 0 	1x	1x	1x	1x
Cable for buzzer 449 443 XXX 0	1x	1x	1x	1x
Cable for clearance lights 449 908 060 0	1x	1x	1x	1x
Clearance lights Not part of WABCO's scope of supply	2x	2x	2x	2x
Aspöck adapter 65-6111-007 	Optional	Optional	Optional	Optional

### Installation

Information on installation ► chapter "8.9 Installing the TailGUARD™ components", page 161.

## 7.1.2 Connecting ISO 12098

The connection from ISO 12098 (for the actuation of the clearance lights) is done in an existing and additional junction box ▶ chapter "8.9 Installing the TailGUARDTM components", page 161.

### Wiring concept for junction box

	ELECTRONIC EXTENSION MODULE TERMINALS GIO12	CABLE COLOUR ISO 4141	ISO 12098 PIN	TERMINAL
Reversing lamp	1	Pink	8	L
CAN High (optional)	2	White/green	14	–
CAN Low (optional)	3	White/brown	15	–
Ground "Light"	4	White	4	31
Rear light "left on"	5	Black	5	58L
Clearance light "left off"	6	Yellow/black	–	–
Clearance light "right off"	7	Yellow/brown	–	–
Rear light "right on"	8	Brown	6	58R

The following products support a simplified connection to the vehicle's electrical system:

- Aspöck: ASS3 with direct connection 76-5123-007
- Hella: EasyConn 8JE 340 847-001

## 7.1.3 Battery supply and battery charging

### Application

Vehicles with ECAS functionality via TEBS E

### Purpose

GIO and ECAS functions upon ignition off or disconnected trailer.

### Function

#### Wake-up (activation of the battery supply)

- Press the button < 5 seconds.

The TEBS Modulator is switched on, but only the GIO functions are available.

The GIO functions remain active for a time predefined in the parameters (ECU stand-by), and then the battery operation switches off.

#### Shutdown before the end of the stand-by time

- Press the button > 5 seconds.

TEBS E2.5

Extending the stand-by time: If the button is pressed again before the stand-by time has elapsed, the time doubles. Multiple button presses multiply the stand-by time (possible up to 10x).

**Battery supply:** As long as no power supply is provided by the towing vehicle, the above indicated functions can be supplied by the battery in the trailer. To

avoid a total discharge, the supply is shut down at approximately 90 % of the nominal battery voltage.



**Battery charge:** The battery is charged from 2 - 10 Ah at up to 2.5 A via TEBS E and the electronic extension module, if ISO 7638 is plugged in. If a battery of greater capacity is already in the trailer vehicle, e.g. for operating a cooling unit, this can also be used for the stand-by time. Charging this battery via TEBS E and the electronic extension module is not permissible, however, and must be deactivated by parameter.

! This function is only supported by the electronic extension module 446 122 070 0.

## Connecting the components

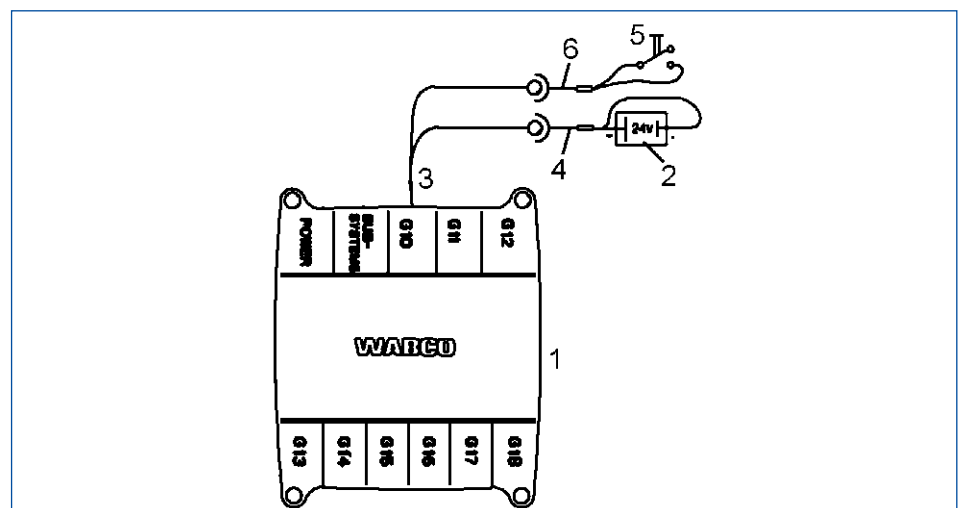
Excerpt from schematic diagram 841 802 250 0 – GIO/ECAS function with battery



ITEM	PART NUMBER	FIGURE	DESCRIPTION
1	446 122 070 0		Electronic extension module
2	446 156 090 0 (without batteries)		Battery box <ul style="list-style-type: none"> <li>■ Recommended: 2x Panasonic lead gel batteries</li> <li>■ series LC-R127R2PG; 12 V;</li> <li>■ 7.2 Ah</li> </ul>
3	449 803 022 0		Battery distribution cable
4	449 807 050 0		TEBS E battery cable
5	Not part of WABCO's scope of supply		Wake-up button
6	449 714 XXX 0		Coupling connector with cable

## Parameter setting

This trailer battery is defined in the TEBS E diagnostic software in *tab 10, Electronic Extension Module*.

A stand-by time (ECU stand-by) is configured in *tab 8, General Functions*.

Which GIO slots are to be used is defined in *tab 11, Connectors, Electronic Extension Module*.

## 7.2 Trailer Remote Control

### Application

Can be used in every towing vehicle, but only in combination with the electronic extension module and **from version TEBS E2 Premium**.

### Purpose

The Trailer Remote Control is a display and remote control unit for TEBS E functions and a distance display for TailGUARD™ functions in the trailer.

### Function

The Trailer Remote Control is mounted in the driver cabin. With this remote control unit the driver can operate functions in the trailer, observe the status of different functions and prepare vehicle for loading and unloading procedures. If the TailGUARD™ function is installed, the distance and position of a detected object can be visually and acoustically displayed via the Trailer Remote Control.

When turning on the supply voltage to the Trailer Remote Control a short acoustic and visual text will be carried out (0.5 seconds). The actual system configuration that is stored in TEBS E will be transferred to the Trailer Remote Control via PLC (Power Line Communication). The key assignment preconfigured in the TEBS E will be verified against the transferred system configuration. The available functions will be shown with lighting buttons.

**!** This function is only supported by the electronic extension module 446 122 070 0.

### Installation

Please refer to the publication "Trailer Remote Control – Installation and connection instructions" for a detailed description of how to install and connect the Trailer Remote Control ▶ chapter "8 Installation notes for vehicle construction and retrofitting", page 149.

### Components

PART NUMBER	FIGURE	DESCRIPTION
446 122 080 0		<p>Trailer Remote Control</p> <ul style="list-style-type: none"> <li>■ Can only be used in combination with the electronic extension module and <b>from version TEBS E2 Premium</b>.</li> <li>■ Scope of delivery: <ul style="list-style-type: none"> <li>■ Connection cable between the Trailer Remote Control and the fuse box in the truck</li> <li>■ Mounting bracket</li> </ul> </li> </ul>

## Operation

Operating information ▶ chapter "10.2 Operation with the Trailer Remote Control", page 181 and "Trailer Remote Control – Operating Manual" ▶ chapter "Technical documents", page 8.

## Parameter setting

The connection to the Trailer Remote Control is switched on (communication to the TRC active) in the TEBS E diagnostic software in *tab 10, Electronic Extension Module*.

## 7.3 External ECAS

### Vehicle type

Vehicles with air suspension that require ECAS functions which TEBS E does not provide.

Only in conjunction with the TEBS E Premium Modulator / TEBS E Multi-Voltage Modulator.

### Purpose

- Implementation of 3-point control
- Tire deflection compensation
- Lateral control for dumpers

### Function

The operating data between TEBS E and ECAS is exchanged via the K-Line. The internal level control functions of the TEBS E are deactivated; the ECAS-ECU is prioritised.

#### TEBS E4

With TEBS E4 or higher, the External ECAS is only supported by the TEBS E Multi-Voltage.

If a repair is required, a Reman modulator should be used.

The TEBS E should take over control of the lifting axles. Only then is the position of the lifting axle(s) transmitted correctly to the towing vehicle.

Please refer to the publication "External ECAS for Trailer Vehicles – System Description" ▶ chapter "2 General information", page 7 => section "Technical documents", for a detailed description of the system.

### Components

PART NUMBER	FIGURE	DESCRIPTION
446 055 066 0		External ECAS <ul style="list-style-type: none"><li>■ Cable for external ECAS: 449 438 XXX 0</li></ul>
Solenoid valves and sensors are also required.		

### Parameter setting

Support for the external ECAS function is activated in the TEBS E diagnostic software in *tab 2, Vehicle*.

## 7.4 Trailer Central Electronic

### Application

The Trailer Central Electronic is upstream of the TEBS E.

**!** The TEBS E Multi-Voltage Modulator cannot be combined with Trailer Central Electronic.

### Purpose

Electrical supply, sensor data transfer (bellows pressure sensor, wear sensor) and monitoring of the TEBS E via the CAN line.

Only the speed sensors and a possibly installed nominal value pressure sensor have to be connected to the TEBS.

The Trailer Central Electronic can also be used for additional functions such as lifting axle control or brake lining wear indication.

### Function

Please refer to the publication "Trailer Central Electronic I / II Central Electronics in Trailer Vehicles – System Description" ▶ chapter "2 General information", page 7 => section "Technical documents" for a detailed description of the system.

### Components

PART NUMBER	FIGURE	DESCRIPTION
446 122 001 0		Trailer Central Electronic <ul style="list-style-type: none"> <li>■ Cable for Trailer Central Electronic: 449 348 XXX 0</li> </ul>
Solenoid valves and sensors are also required.		

### Start-up

For start-up, TEBS E is put into operation first and then Trailer Central Electronic.

#### TEBS E4

Trailer Central Electronic is no longer supported.

If a repair is required, a TEBS E Reman Modulator should be used. As an alternative, the supply can be implemented using the Premium version of TEBS E4 or higher. The cable 449 348 XXX 0 is split in a distributor box for this purpose: A cable 449 349 XXX 0 is used to connect the supply voltage to IN/OUT and CAN is connected using a cable 449 611 XXX 0 to GIO5.



### 7.5 Tire pressure monitoring (OptiTire™)

#### Vehicle type

All trailers.

#### Purpose

Permanent monitoring of the tire pressure on all wheels with pressure sensors. Around 85 % of all punctures are caused by driving the vehicle with incorrect tire pressure or creeping pressure loss while the vehicle is in motion.

#### Function

The tire pressures measured by the pressure sensor are transmitted to the towing vehicle via the CAN bus and are usually displayed on the dashboard in towing vehicles built 2007 or more recently.

Additionally the pressures can be displayed via the SmartBoard or IVTM display. The driver is warned on time with creeping or critical pressure loss. A test using a pressure gauge is no longer required.

**Warning indicator / warning lamp:** If IVTM detects a tire pressure that is too low, the warning indicator/warning lamp starts to flash on the instrument panel after the ignition is turned on. If the Trailer Remote Control is installed, the warning indicator for tire pressure is illuminated.

Pressure loss 1 - 29 %: flashing yellow warning indicator/warning lamp

Pressure loss > 29 %: flashing red warning indicator/warning lamp

---

**!** OptiTire™ is for assistance only and does not release the driver from his obligation to visually check the tires as well.





---

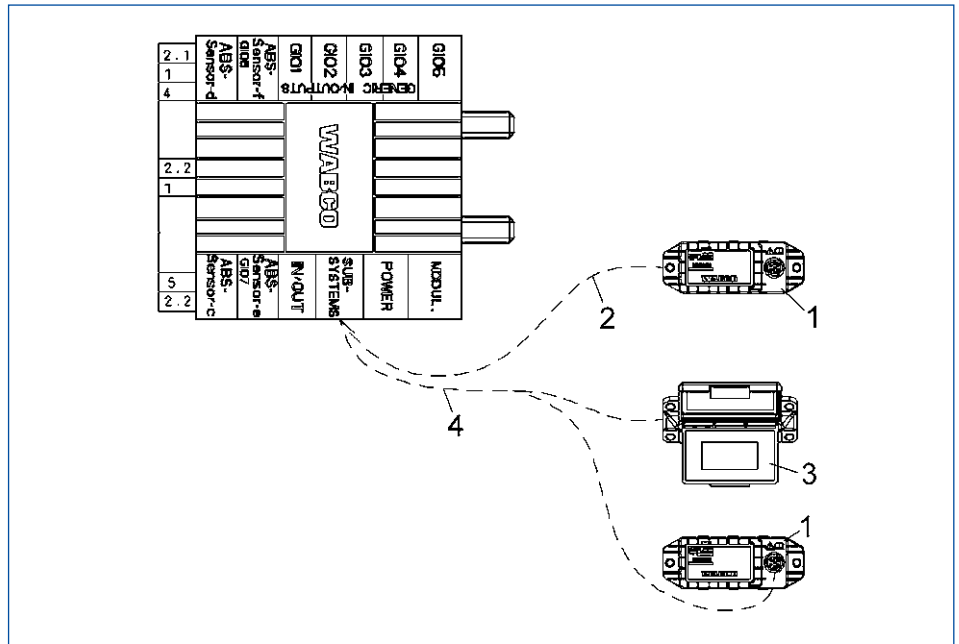

Please refer to the publication "OptiTire™ – System Description" ▶ chapter "2 General information", page 7 => section "Technical documents", for a detailed description of the system.

## Connecting the components

Extract from schematic diagram 841 802 150 0



ITEM	PART NUMBER	FIGURE	DESCRIPTION
1	446 220 110 0		OptiTire™ electronics
	446 220 013 0		IVTM electronics
2	449 913 XXX 0		Cable for IVTM / OptiTire™
	894 600 001 2		OptiTire™ adapter (bayonet to HDSCS)
The following components can be used for indication and operation:			
3	446 192 11X 0		SmartBoard (optional)

ITEM	PART NUMBER	FIGURE	DESCRIPTION
4	449 916 XXX 0		Cable for SmartBoard and IVTM / OptiTire™
	446 122 080 0		Trailer Remote Control (optional) <ul style="list-style-type: none"> <li>■ Can only be used in combination with the electronic extension module and <b>from version TEBS E2 Premium</b>.</li> <li>■ Scope of delivery:               <ul style="list-style-type: none"> <li>■ Connection cable between the Trailer Remote Control and the fuse box in the truck</li> <li>■ Mounting bracket</li> </ul> </li> </ul>
	446 221 000 0		IVTM display

## Parameter setting

The support for OptiTire™ is configured in *tab 4, Standard Functions*.

TEBS E transmits the data received from OptiTire™ via the 24 V CAN bus to the towing vehicle so that the tire pressures can be indicated on the dashboard. Because there are differences in terms of how the data is interpreted there, there are two different modes that optimise the transfer to the respective towing vehicle:

*EBS23 Standard:* Default value, matches most towing vehicles

*EBS23 Group Bit:* "Extends" the fault messages of a wheel to a generic fault message to all wheels on the trailer. This ensures an adequate warning message in a number of Mercedes Actros vehicles.

## 7.6 Telematics (TX-TRAILERGUARD™)

### Vehicle type

All trailers.

### Purpose

The telematics system is used to transfer data and information picked up by sensors in the trailer to a computer at the haulage company over a wireless connection for further processing.

### Function

The range of functions depends on the Trailer EBS E version and the installed components and sensors, as well as on the functional scope of the telematics.

TX-TRAILERGUARD™ is perfectly matched to Trailer EBS E and incorporates all the Premium telematic functions.



Detailed information about TX-TRAILERGUARD™ can be found at <http://www.transics.com/product/trailer-and-asset-solutions/>

### Components

PART NUMBER	FIGURE	DESCRIPTION
		TX-TRAILERGUARD™
Transics 0942-0388-EBS-03		SUBSYSTEMS connecting cable ■ Length: 5 m
Transics 0942-0388-EBS-04		GIO5 connecting cable ■ Only in combination with TEBS E Premium Modulator ■ Length: 5 m



### Parameter setting

The use of TX-TRAILERGUARD™ is configured in the TEBS E diagnostic software in *tab 4, Standard functions*.

Which GIO slots are to be used is defined in *tab 11, Connectors*.

## 8 Installation notes for vehicle construction and retrofitting

### 8.1 Safety information

 <b>WARNING</b>	<b>Damage to the TEBS E Modulator caused by not using original WABCO cables</b> Using cables not authorised by WABCO may result in functional impairments and fault entries. Cables with open ends must be laid in manner that ensures no water can enter the modulator via the cables to damage it. <ul style="list-style-type: none"><li>– <i>Only use original WABCO cables.</i></li></ul>
 <b>WARNING</b>	<b>Dangerous voltages during electrostatic painting and welding</b> Dangerous voltages can damage the electronic control unit. <ul style="list-style-type: none"><li>– <i>If electrostatic painting or welding work is carried out on the vehicle, the following measures must be implemented: Moving or insulated components (such as axles) must be conductively connected to the vehicle frame (chassis) using suitable earth terminals to ensure that no potential differences are allowed to build up and cause a discharge. Alternatively: The ABS connection lines on the modulator must be disconnected and the electrical terminals covered (with sealing plugs for example).</i></li><li>– <i>Ground connections for welding and paint spray systems must always be connected on the parts that are being worked on.</i></li></ul>
<b>CAUTION</b>	<b>Damage to the TEBS E Modulator due to painting over</b> Connector locks and plastic pipes of the pneumatic couplings can no longer be released after painting. <ul style="list-style-type: none"><li>– <i>Do not paint over the modulator.</i></li></ul>

## 8.2 Data on the TEBS E Modulator

### Technical data of the TEBS E Modulator (Premium, Standard, Multi-Voltage)

Permissible maximum temperature (baked finish)	+65 °C permanent; +110 °C for 1 hour with no function
Reverse polarity protection	The system is protected against reverse polarity of the towing vehicle battery.
Undervoltage (terminal 30, terminal 15, 24N)	< 19 V (9.5 V Multi-Voltage in 12 V operation)
Overtoltage (terminal 30, terminal 15, 24N)	> 30 V
Nominal voltage (terminal 30, terminal 15, 24N)	24 V (12 V Multi-Voltage in 12 V operation)
Operating pressure	min. 4.5 to 8.5 bar, max. 10 bar

### Dimensions of the TEBS E Modulator (Premium, Standard, Multi-Voltage)

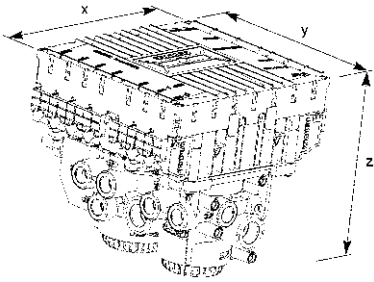
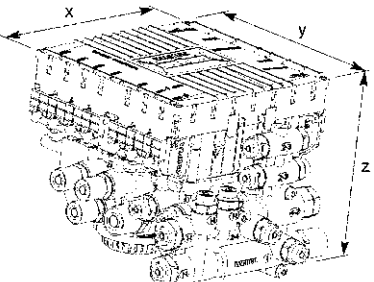
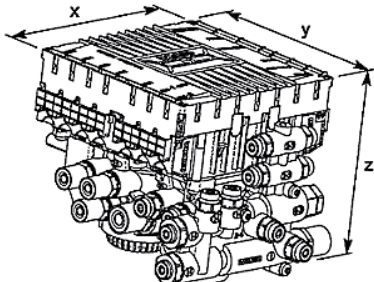
TEBS E MODULATOR WITHOUT PEM	TEBS E MODULATOR WITH PEM (ALUMINIUM)	TEBS E MODULATOR WITH PEM (PLASTIC)
 <p>Width X: 224.0 mm Depth Y: 197.5 mm Height Z: 197.3 mm</p>	 <p>Width X: 237.2 mm Depth Y: 274.4 mm Height Z: 197.3 mm</p>	 <p>Width X: 224.0 mm Depth Y: 254.0 mm Height Z: 197.3 mm</p>

### WABCO Default setting of the TEBS E Modulator (Standard, Premium, Multi-Voltage) ex works

#### Parameter setting

- 3-axle semitrailers
- 2S/2M
- Second axle is main axle (ABS rotational speed sensor for axle c-d)
- LSV identifier 1:1
- No GIO functions active
- ABS-pole wheel with 100 teeth
- Tire circumference: 3,250 mm

The electrical connections POWER and ABS-d, ABS-c have no protective covers.

## 8.3 Connections

### Electrical connections

The electrical connections are clearly designated on the top side of the modulator. The cables are respectively inserted at the bottom.

A corresponding coding prevents making incorrect contacts. Coding and pins are described in detail in the appendix.

### Pneumatic connections

Connections with identical designations are connected with one another in the TEBS E Modulator / PEM.

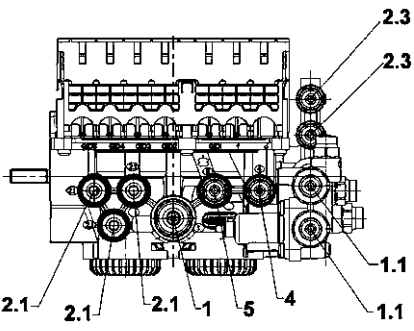
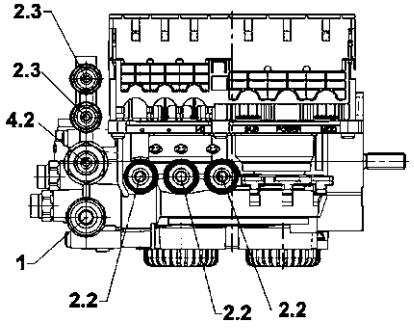
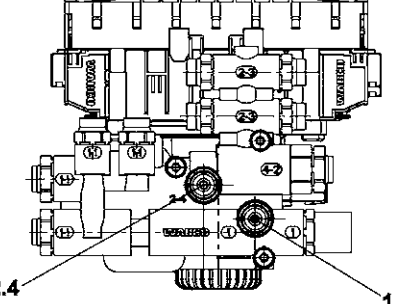
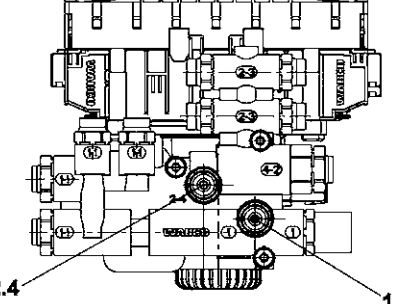
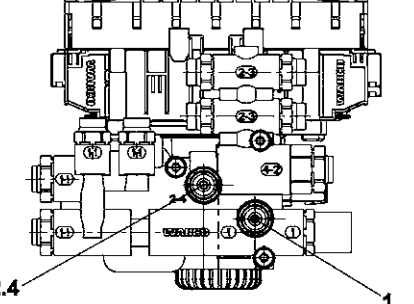
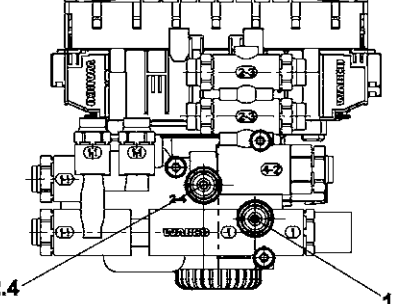
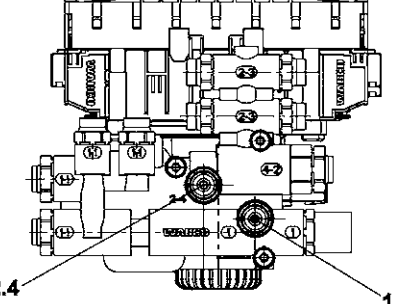
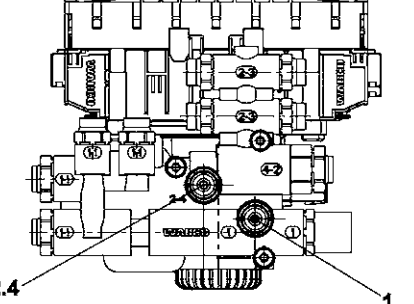
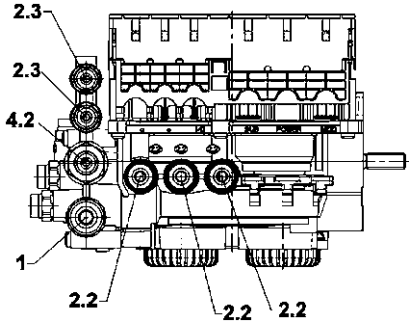
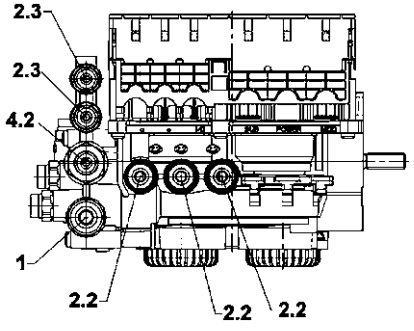
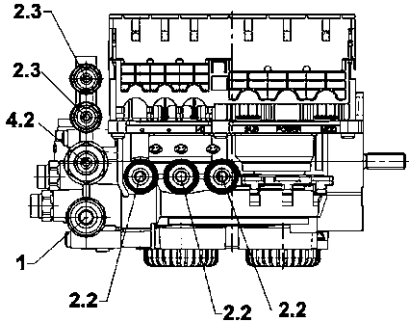
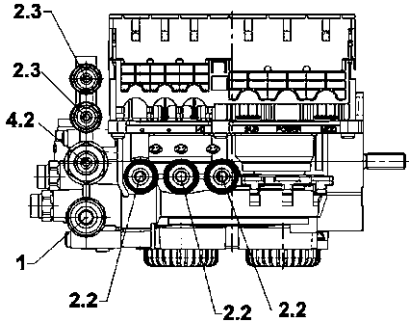
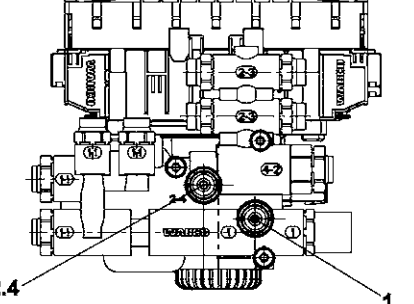
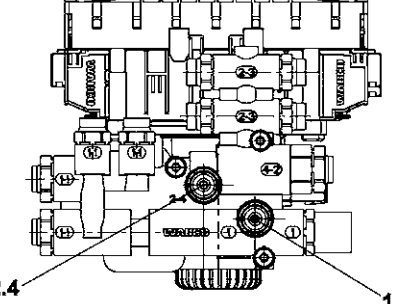
TEBS E MODULATOR WITH PEM	CONNECTIONS	
	1	Supply (from reservoir "Brake")
	1.1	Supply "Air suspension" (to levelling valve, rotary slide valve, lifting axle valve or ECAS block)
	2.1	Braking pressure (to the brake cylinder)
	2.2	Braking pressure (to the brake cylinder)
	2.3	Tristop™ cylinder (to Tristop™ cylinder 12)
	2.4	Test connection "Brake"
	4	Control pressure (from PREV 21)
	5	Bellows pressure (from air-suspension bellows)
	1	Supply (from reservoir "Brake")
	2.2	Braking pressure (to the brake cylinder)
	2.3	Tristop™ cylinder (to Tristop™ cylinder 12)
	4.2	Control pressure (from PREV 22)
	1	Connection 1-2 PREV
	2.4	Test connection "Brake" (to pressure gauge)

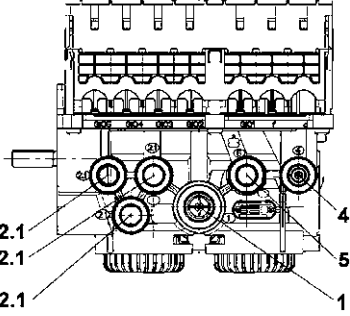
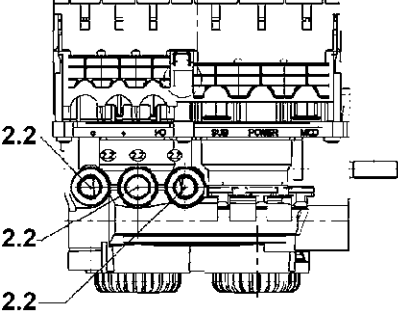
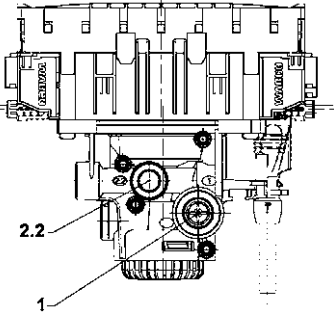
TEBS E MODULATOR WITHOUT PEM	CONNECTIONS	
	1	Supply (from reservoir "Brake")
	2.1	Braking pressure (to the brake cylinder)
	4	Control pressure (from PREV 21)
	5	Bellows pressure (from air-suspension bellows)
	2.2	Braking pressure (to the brake cylinder)
		1
2.2		Test connection "Brake" (to pressure gauge)



## 8.4 Installation in vehicle

! Before you start the installation you must note the safety instructions on the subject of ESD ▶ chapter "3 Safety information", page 11.

### Installation on frame

- Install the modulator according to the outline drawing.
- Make sure that there is a conducting ground connection between the modulator and the vehicle frame (resistance must be less than 10 Ohm). The same applies to the connection between an EBS relay valve and the frame.



#### Tender drawing for the TEBS E Modulator

- Open the WABCO INFORM online product catalogue: <http://inform.wabco-auto.com>
- Search for the tender drawing by entering the part number of the TEBS E Modulator.

The installation position can be in the driving direction or against the driving direction (stud bolts face driving direction).

### Parameter setting for installation position

- The parameters for the installation position are configured in the TEBS E diagnostic software in *tab 2, Vehicle*.
  - ⇒ The silencers must be open to the atmosphere and always point perpendicular to the floor (downwards) ▶ chapter "8.4.1 RSS installation regulation", page 154.

### Mounting on cross member

The cross-member must be connected to the two longitudinal beams of the vehicle mass in a friction locked manner.

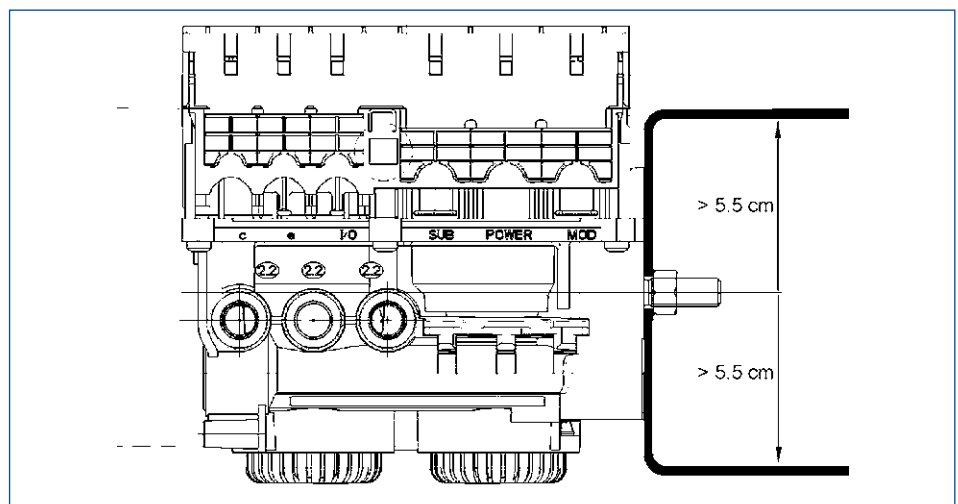

- Mount the modulator on a sufficiently sized U-section, angle section, or a suitable reinforced member that is at least 4 mm thick (applies to steel sections).

- The height of the mount must be greater than the flange-surface of the modulator so that the flange makes full contact with the mount.
  - Washers or spring lock washers are only permitted directly under the nut.
  - The tightening torque of the nuts is 85 Nm.
- Note the installation regulations for RSS as well ▶ chapter "8.4.1 RSS installation regulation", page 154.

## 8.4.1 RSS installation regulation

The parameters for the circumference of the installed tires and the number of teeth of the installed pole wheel must be defined because these input values are used to calculate the required value of lateral acceleration which represents a risk of tipping.

The Roll Stability Support (RSS) function depends on the accuracy of the Parameter setting for the tire circumferences, number of pole wheel teeth and the other data in the brake calculation.

---

**!** With inaccurate data the function does not work properly.

---

Faultless function is only possible if the actual tire size is no more than 8 % smaller than the defined value. The defined number of teeth on the pole wheel must correspond with the installed amount.

Please refer to the WABCO brake calculation for the values for the permitted tire circumference range and the LSV data.

---

**!** Never fit tires that are larger than specified; the function will not work properly otherwise.

---

- Calibrate the inclination of the modulator ( $\Delta\beta$ ) using the TEBS E diagnostic software.
- Requirement: The vehicle must be parked on a flat, level surface (deviation from horizontal  $< 1^\circ$ ).
  - If the calibration is not carried out, the modulator inclination will calibrate itself when driving.

# Installation notes for vehicle construction and retrofitting

## Semitrailer/centre axle trailer

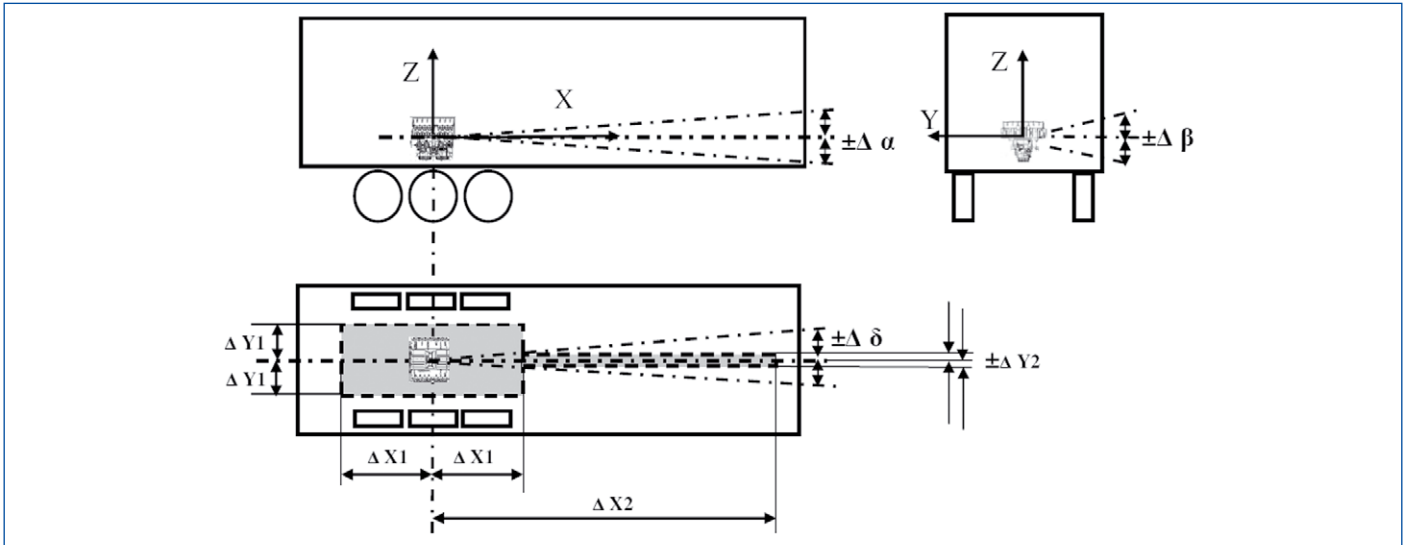

$\Delta X1$ [mm]	$\Delta Y1$ [mm]	$\Delta X2$ [mm]	$\Delta Y2$ [mm]	$\Delta\alpha$	$\Delta\beta$	$\Delta\delta$
2000	500 TEBS E5: 1000	9000	50	$\pm 15^\circ$	$\pm 3^\circ$	$\pm 3^\circ$

## Drawbar trailer

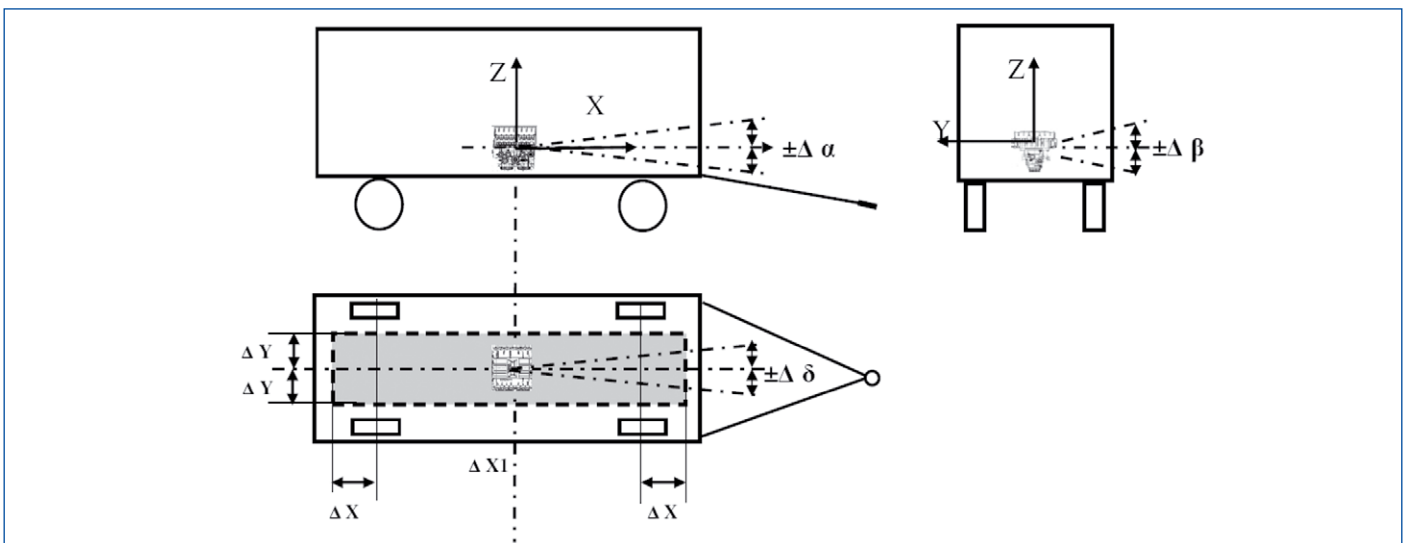

$\Delta X$ [mm]	$\Delta Y$ [mm]	$\Delta\alpha$	$\Delta\beta$	$\Delta\delta$
600	500 TEBS E5: 1000	$\pm 15^\circ$	$\pm 3^\circ$	$\pm 3^\circ$

## Permitted configurations for vehicles with TEBS E and RSS

SYSTEM	NUMBER OF AXLES							
	SEMITRAILER			CENTRAL AXLE TRAILER			DRAWBAR TRAILER	
2S/2M	1	2	3	1	2	3	–	–
4S/2M	–	2	3 ... 6	–	2	3	–	–
2S/2M+Select Low valve	–	2	3	–	2	3	–	–
4S/2M+1M	–	2	3 ... 6	–	2	3	–	–
4S/3M	–	2	3 ... 6	–	2	3	2	3
Mechanical suspension	1	2	3 ... 6	1	2	3	2	3

## 8.5 Cable installation / cable fastenings

### CAUTION

#### Damage to the cable

- Water that enters the cable core can damage the TEBS E Modulator. Only use original WABCO cables. Using cables of third party manufacturers will render any claims for consequential damage invalid.
- Plan your installation position so that cables cannot become kinked.
- Fasten the cable and plug so that no tension or lateral forces affect the plug connections.
- Never route cables over sharp edges or in the vicinity of aggressive media (e.g. acids).
- Route the cable to the connections so that water cannot enter the plug-in connector.

### Cable- / dummy cap installation

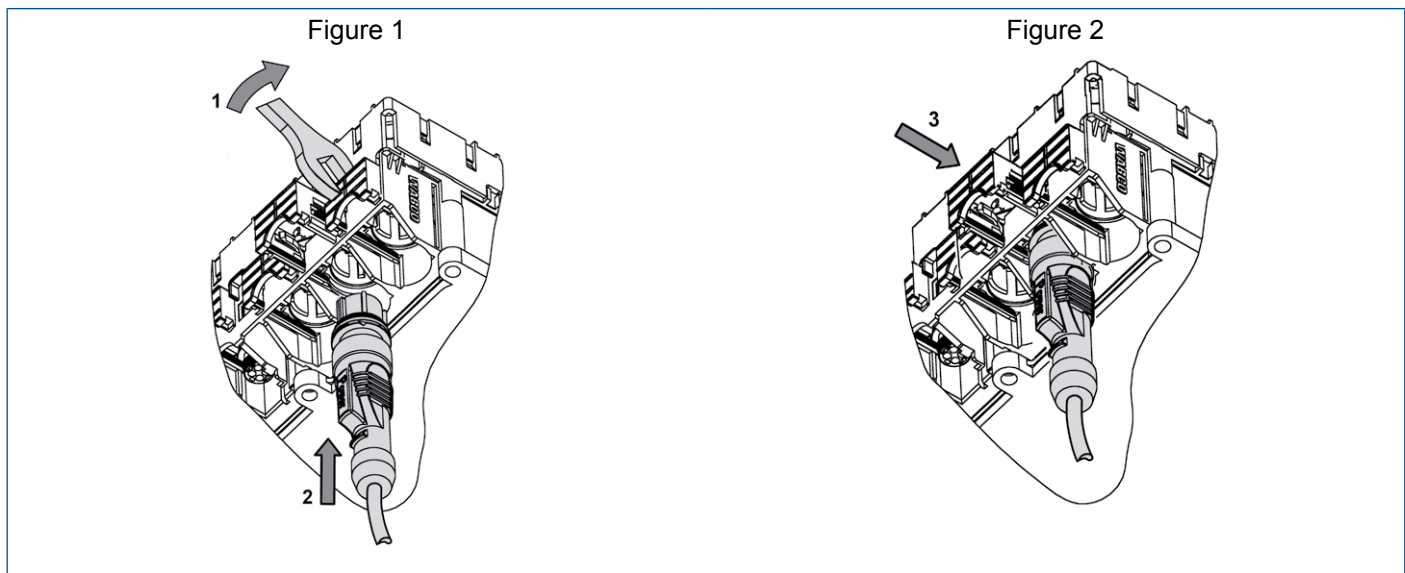

# Installation notes for vehicle construction and retrofitting

- Open the yellow slider for the lock before you insert or remove the cable end sockets (socket housing) into the respective slot on the ECU frame.
  - If the slider is in the locked end position (condition at delivery), you can use a size 13 open-end spanner to release the notch from either the top or from below (Figure 1, Position 1).
- Then pull out the slider up to the cover end stop by hand in order to permit access to the connector guide.
- Insert the cable ends (or the dummy cap) vertically on the respective slot of the ECU (e.g. power cable to POWER connection).
  - 8-pin cable for POWER, SUBSYSTEMS and MODULATOR to GIO10-12
  - 4-pin cables for GIO1-7, ABS c, d, e and f, IN/OUT to GIO13-18
  - Ensure that the correct polarity and coding (connector to slot) is adhered to. They can only be inserted if the two parts match.
  - The black dummy caps for the 4- and 8-pin slots are not coded and match the respective slot.
  - All connectors to the ECU are marked in colour. The colour coding is found in the overview of cables ▶ chapter "12.3 Cable overview", page 209.
- Press the cable end into the slot (Figure 1, Position 2) with a little initial force and push the locking slider back to its initial position (Figure 2, Position 3).
  - ⇒ In this procedure, the hook of the slider latches in the ECU frame. The correct latching of the slider is confirmed by an audible "click" sound.

## CAUTION

### Damage to the power cable

To avoid damaging the connector when the cable is pulled through, the connector is enclosed by a protection cap.

- *Carefully remove the protective cap when connecting the cable to the ECU so that the seal will not be damaged or slip.*

## Cable fixation

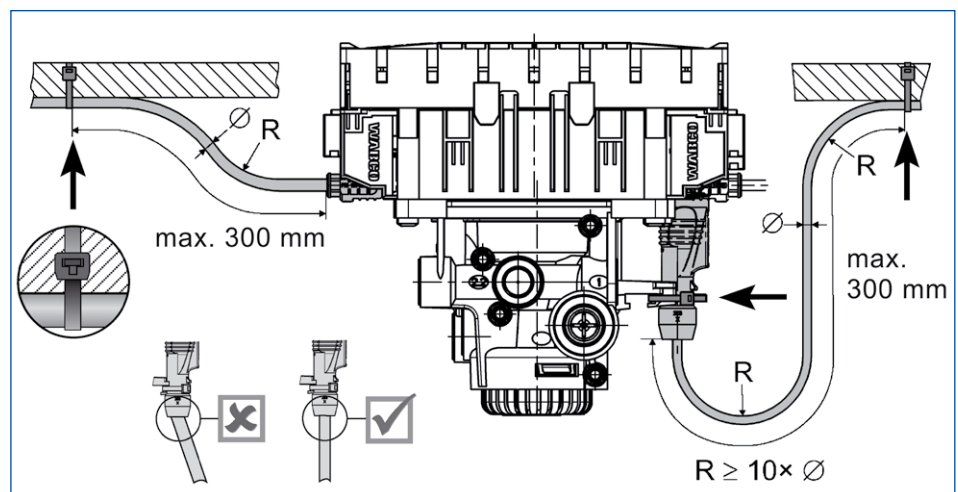

## CAUTION

### Damage to the distance sensor cable

The connector of the distance sensor cable can be damaged by cable ties.

- *Do not attach a cable tie to the distance sensor cable if it bends the connector.*

- Fix the cables (maximum 300 mm cable length distance to the ECU) using cable ties (black arrows).
  - The 8-pin cables of the ports POWER, SUBSYSTEMS and MODULATOR must be fixed on the TEBS E using the fixing points provided.

## 8.6 Installing the height sensor

Height sensor 441 050 100 0 is used to both measure the normal level for vehicles with electronic air suspension (ECAS functions) and for determining the axle load with mechanical suspension.

- Install the height sensor in such a way that the two mounting holes are horizontal and facing upward.
  - A lever is used for linking the height sensor lever.
  - The length of the height sensor lever can be set.
  - On vehicles with long compression travel, use a longer lever.

! The maximum excursion of the lever  $\pm 50^\circ$  may not be exceeded.

■ The lever length should be chosen so that the entire suspension path of the frame utilises a deflection of at least  $\pm 30^\circ$ .

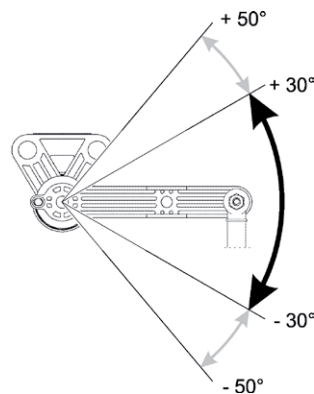

- It is important that the height sensor always moves freely across its operating range, and that the lever can only move in the way intended.
- The height sensor and the level both have a fastening hole (4 mm) for locking the lever into the optimum position for the normal level.



- The linkage for the height sensor should be fastened so that the lever is horizontal at normal level.
- The connection to the axle may be achieved by means of the linkage.
- The rubber link of the lever should be connected by a 6 mm rod (solid) to the linkage on the axle.

## ECAS vehicles

Diagram ▶ chapter "12.4 GIO schematic diagrams", page 218.

### 1-point control

- Move the height sensor to the middle of the main axle to prevent damage to the height sensor when cornering with a large degree of vehicle tilt.

### 2-point control

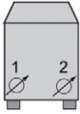

- On drawbar trailers, move the height sensor to the middle of the front axle and rear axle to prevent damage to the height sensor when cornering with a large degree of vehicle tilt.  
On semitrailer vehicles, move the height sensors as far away to the left and right of the vehicle centre as possible. Make sure that damage cannot be caused when cornering.

	Drawbar trailer	Semitrailer
		
Height sensor "rear axle left"	Rear	Left
Height sensor "front axle right"	Front	Right

## Vehicle with mechanical suspension

- Move the height sensor to the middle of the main axle.
  - Make sure that structural movement does not "knock over" or break the sensor.
  - Always use the bore hole with 100 mm distance to the turning shaft of the height sensor.
  - The black lever on the height sensor is not to be extended because the load information would become imprecise and represent an incorrect braking pressure.

- The lever of the height sensor must be directly connected with the rubber link of lever 441 901 71X 2.
- The lever is supplied complete, including two rubber links and connecting rod in various lengths.
- The connection to the axle is made with an angle iron welded to the axle.
- For vehicles with two height sensors, the rear axle left height sensor must be connected to the axle c-d sensed by ABS, and the front axle right height sensor to axle e-f sensed by ABS.

 <b>WARNING</b>	<p><b>Malfunctions with TEBS E when installing incorrect height sensors</b>            Installing height sensors other than those stipulated can cause malfunctions with TEBS E.</p> <ul style="list-style-type: none"> <li>– <i>Install only original WABCO height sensors.</i></li> </ul>
 <b>WARNING</b>	<p><b>Malfunctions with TEBS E when installing on tag and lifting axles</b>            Installing the height sensors on tag or lifting axles can lead to malfunctions.</p> <ul style="list-style-type: none"> <li>– <i>Only install the height sensors on the main axle (c-d).</i></li> </ul>

## 8.7 Installing the immobilizer components

- Install the immobilizer according to diagram 841 701 227 0 ▶ chapter "12.5 Braking diagram", page 220.
- Pay attention to the information on the proposal drawing 463 084 100 0 when installing the pulse-controlled lifting axle valve.



### Proposal drawing for immobilizer

- Open the WABCO INFORM online product catalogue: <http://inform.wabco-auto.com>
- Search for the tender drawing by entering the product number 463 084 100 0.

TEBS E1.5

The lifting axle valve can be connected to GIO2 or GIO3.

TEBS E2

The lifting axle valve can be connected to GIO1, GIO2 or GIO3.



## 8.8 Installing the Trailer Remote Control

Please refer to the publication "Trailer Remote Control – Installation and connection instructions" for a detailed description of how to install and connect the Trailer Remote Control, ▶ chapter "Technical documents", page 8.

## 8.9 Installing the TailGUARD™ components

### Required components

In addition to TEBS E, the electronic extension module, LIN ultrasonic sensors, Trailer Remote Control (optional) and respective cables are required. The rear light and reversing lamp signal (ISO 12098) must be connected through a junction box to the electronic extension module.

Additional information on the components ▶ chapter "7.1.1 TailGUARD™ functions", page 134.

! The TailGUARD™ function is only possible with the ISO 7638 connection plugged in.

A 24N supply is not sufficient.

### LIN ultrasonic sensors

 <b>WARNING</b>	<b>Risk of accidents: TailGUARD™ function not available due to incorrect installation of LIN ultrasonic sensors</b> If the LIN ultrasonic sensors are installed incorrectly, objects may not be detected so that the correct function of the system cannot be guaranteed. – <i>Install the LIN ultrasonic sensors according to the diagrams.</i>
<b>CAUTION</b>	<b>Damage to the LIN ultrasonic sensors</b> The sensors must not be used as a climbing aid. – <i>Mount the sensors in a robust protective enclosure if necessary.</i>

The LIN ultrasonic sensors are not to be mounted in a U-profile because this could cause reflections.

The surface where a LIN ultrasonic sensor is mounted must be level and must be a minimum of 2 mm bigger than the LIN ultrasonic sensor (protection of drainage holes in the rear against direct high-pressure cleaning).



### Fitting dimensions for LIN ultrasonic sensors

- Open the WABCO INFORM online product catalogue:  
<http://inform.wabco-auto.com>
- Search for the tender drawing by entering these product numbers: 446 122 401 0 / 446 122 402 0 / 446 122 404 0.

# Installation notes for vehicle construction and retrofitting

Since all ultrasonic sensors communicate in parallel via a data bus, an optional, parallel circuit on GIO17 and GIO18 is possible.

## Electronic extension module

The cover of the electronic extension module must be removed for installing/removing the cable.

- Use a screwdriver with a minimum length of 11 cm to release the catch on the housing to remove the cover – as illustrated in the figure below.



- Mount the electronic extension module vertically only, with the cable openings facing the bottom or the side.

## Installation dimensions

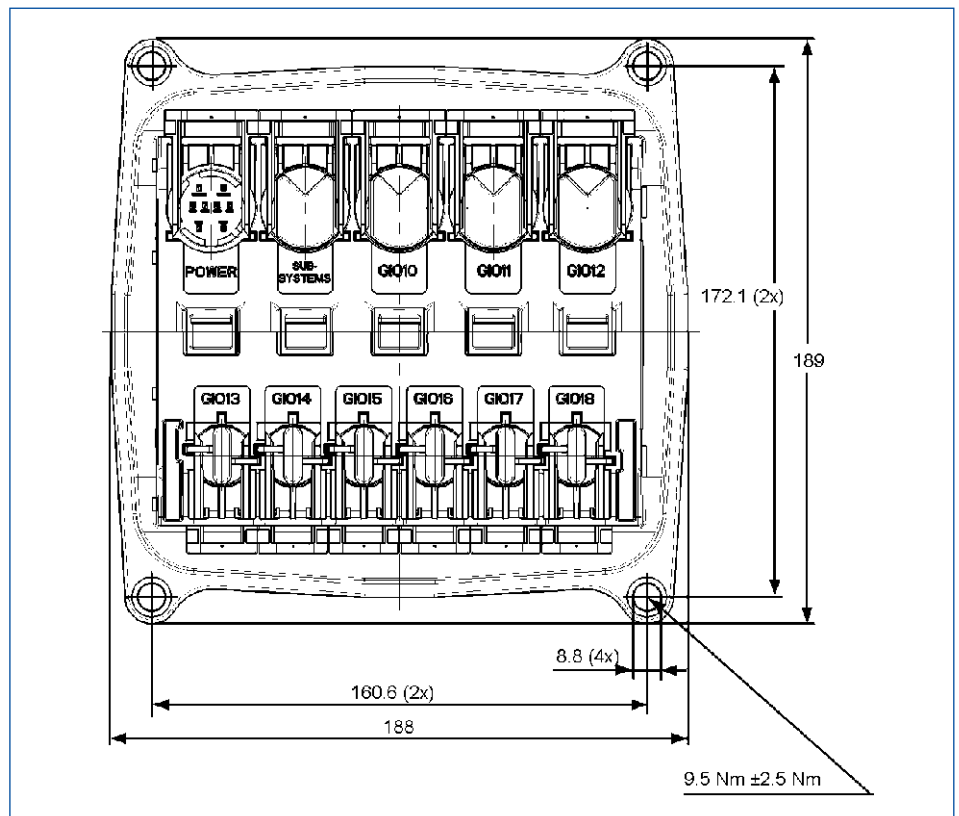

- Fasten the connector housing of the 8-pin plug-in connector with cable ties on the respective bracket catch.
- Once the cable has been installed, mount the cover again.
  - Make sure that all catches are firmly in place.
  - The open side must face in the direction of the 4-pin slots.

# Installation notes for vehicle construction and retrofitting

## TailGUARDlight™

- Mount the 2 LIN ultrasonic sensors 446 122 401 0 (0°) horizontally at a maximum of 0.12 m from the right or left outer edge of the vehicle to detect the vehicle outer dimensions exactly.
  - If this is not necessary, you can also mount the LIN ultrasonic sensors closer together.
- *Install depth sensor:* In the TEBS E diagnostic software *tab 10, Electronic Extension Module* enter the position of the LIN ultrasonic sensor (distance vehicle to rear side) – in relation to the last vehicle edge.
  - This distance should not be more than 35 cm.

If protruding ramps are supposed to be detected, at least one LIN ultrasonic sensor must be mounted at the height of the ramp (buffer).

Note the following install dimensions:

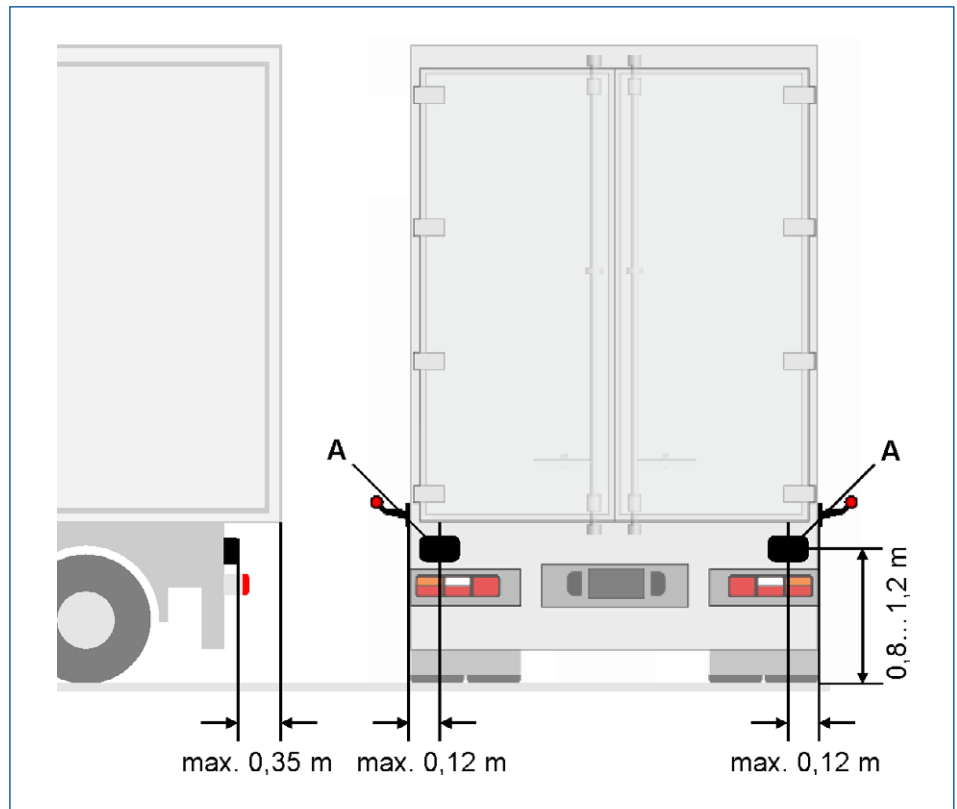

### LEGEND

A LIN ultrasonic sensor 0° 446 122 401 0

# Installation notes for vehicle construction and retrofitting

## System configuration – TailGUARDlight™

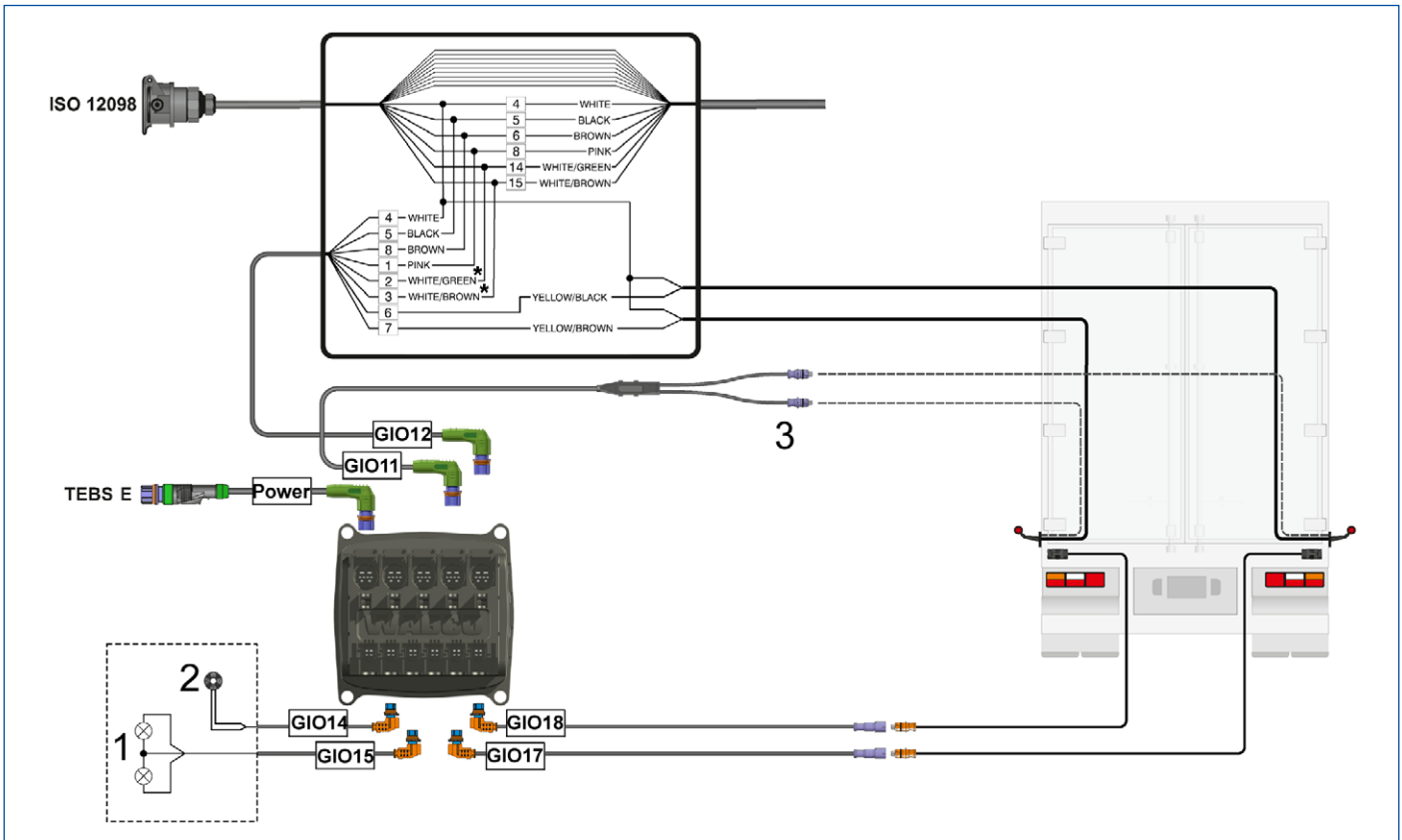

### LEGEND

1	External lights (optional)
2	Buzzer (optional)
3	Distributor 894 600 024 0
*	CAN communication to towing vehicle (optional)
<b>GIO11</b>	Cable for clearance lights 449 803 022 0
<b>GIO12</b>	Universal cable 449 908 060 0; alternatively: Aspöck cable 65-6111-007
<b>GIO14, GIO15</b>	Universal cable 449 535 XXX 0 (4-pole, open)
<b>GIO17, GIO18</b>	Cable for LIN ultrasonic sensor 449 806 060 0
<b>POWER</b>	Power supply cable for electronic extension module 449 303 020 0

Wiring concept for junction box (function and colour table) ▶ chapter "7.1.2 Connecting ISO 12098", page 140.  
Schematic diagram 841 802 280 0 ▶ chapter "12.4 GIO schematic diagrams", page 218.

# Installation notes for vehicle construction and retrofitting

## TailGUARD™

- Mount the outside LIN ultrasonic sensors 446 122 402 0 / 446 122 404 0 (15°) inclined vertically inwards.
- Mount the LIN ultrasonic sensor 446 122 401 0 (0°) centrally.
- **As of version TEBS E2.5:** For better detection of hollow (protruding) ramps the central LIN ultrasonic sensor 446 122 401 0 can also be installed horizontally so that the ultrasonic lobe is on end.
  - If installed horizontally, the minimum height of the LIN ultrasonic sensor is 0.8 m ( ▶ table "Installation options").
  - With TEBS E2, the central LIN ultrasonic sensor must be installed vertically.
- The parameters for the installation position are configured in the TEBS E diagnostic software.
- Mount the central LIN ultrasonic sensor at max. 15 cm up or down.

Note the following install dimensions:

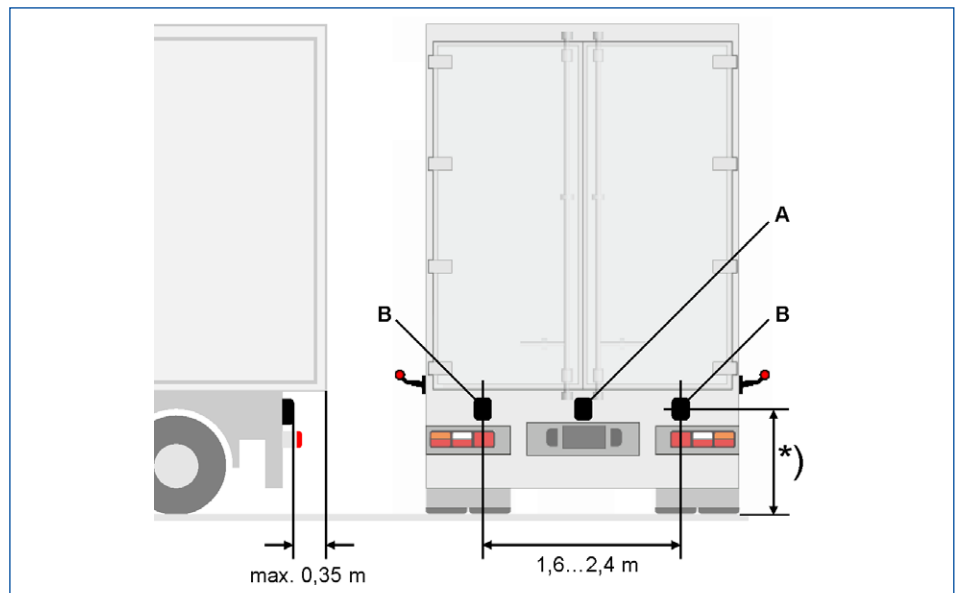

### LEGEND

<b>A</b>	LIN ultrasonic sensor 0° 446 122 401 0
<b>B</b>	LIN ultrasonic sensor 15° 446 122 402 0 / 446 122 404 0 <b>Do not install horizontally!</b>

Please observe the table on installation for LIN ultrasonic sensor alignment:

### Installing the LIN ultrasonic sensors

FROM VERSION TEBS E2 AND ELECTRONIC EXTENSION MODULE VERSION 0	FROM VERSION TEBS E2.5 AND ELECTRONIC EXTENSION MODULE VERSION 1
Outside 446 122 402 0 / 446 122 404 0 – 15° vertical	Outside 446 122 402 0 / 446 122 404 0 – 15° vertical
Inside 446 122 401 0 – 0° vertical	Inside 446 122 401 0 – 0° horizontal
Installation height 0.4...1.6 m ( ▶ illustration "TailGUARD™ installation dimensions")	Installation height 0.8...1.6 m ( ▶ illustration "TailGUARD™ installation dimensions")

# Installation notes for vehicle construction and retrofitting

## System configuration – TailGUARD™

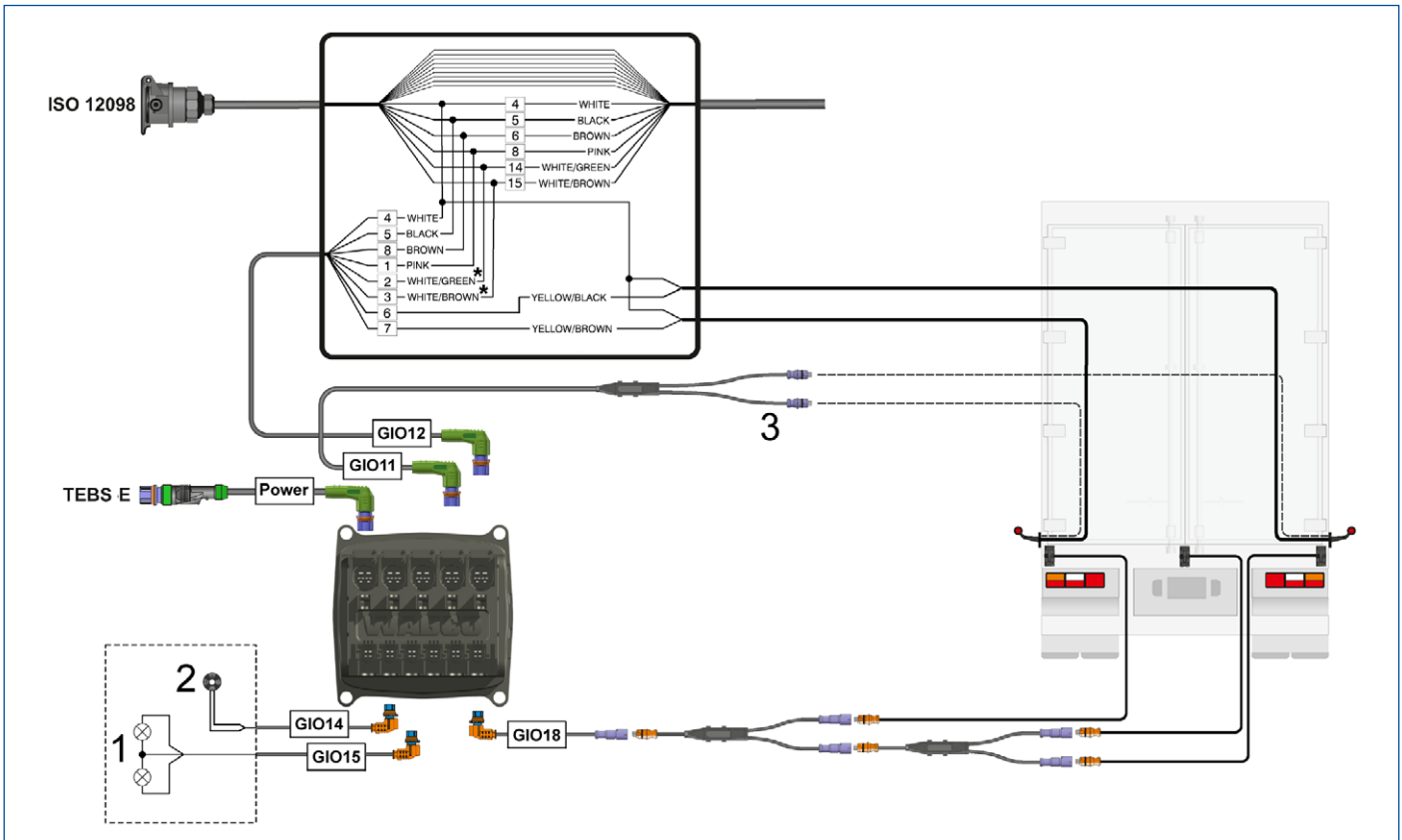

### LEGEND

1	External lights (optional)
2	Buzzer (optional)
3	Distributor 894 600 024 0
*	CAN communication to towing vehicle (optional)
<b>GIO11</b>	Cable for clearance lights 449 803 022 0
<b>GIO12</b>	Universal cable 449 908 060 0; alternatively: Aspöck cable 65-6111-007
<b>GIO14, GIO15</b>	Universal cable 449 535 XXX 0 (4-pole, open)
<b>GIO18</b>	Cable for LIN ultrasonic sensor 449 806 060 0
<b>POWER</b>	Power supply cable for electronic extension module 449 303 020 0

Wiring concept for junction box (function and colour table) ▶ chapter "7.1.2 Connecting ISO 12098", page 140.  
 Schematic diagram 841 802 281 0 ▶ chapter "12.4 GIO schematic diagrams", page 218.

## TailGUARD<sup>Roof</sup>™

- Mount the 5 LIN ultrasonic sensors vertically in 2 levels.
- On the lower level (main level), mount the outside LIN ultrasonic sensors 446 122 402 0 / 446 122 404 0 (15°) inclined vertically inwards.
- Mount the LIN ultrasonic sensor 446 122 401 0 (0°) centrally, maximum offset 15 cm upwards or downwards.
- Mount both LIN ultrasonic sensors 446 122 402 0 / 446 122 404 0 on the upper level.
- **As of version TEBS E2.5:** The central LIN ultrasonic sensor of the lower level can be installed horizontally or vertically (identical to TailGUARD™).
- The designation has to be entered in the TEBS E diagnostic software in *tab 10, Electronic Extension Module*.
- If installed horizontally, the minimum height of the LIN ultrasonic sensor is 0.8 m ( ▶ table "Installation options").
  - With TEBS E2, the central LIN ultrasonic sensor must be installed vertically.
  - The LIN ultrasonic sensors of the upper level (additional level) can be arranged vertically or horizontally.
  - If installed vertically, the LIN ultrasonic sensors must be installed inclined inwards.
  - To enable detection of roofs even where space is restricted, the upper external LIN ultrasonic sensors can be mounted horizontally. In this event note that 15° LIN ultrasonic sensors (446 122 402 0 / 446 122 404 0) are installed inclined downwards.
  - Object recognition then only occurs in the range of the LIN ultrasonic sensors; wide-range reverse monitoring system is not provided for the upper level.

Note the following install dimensions:

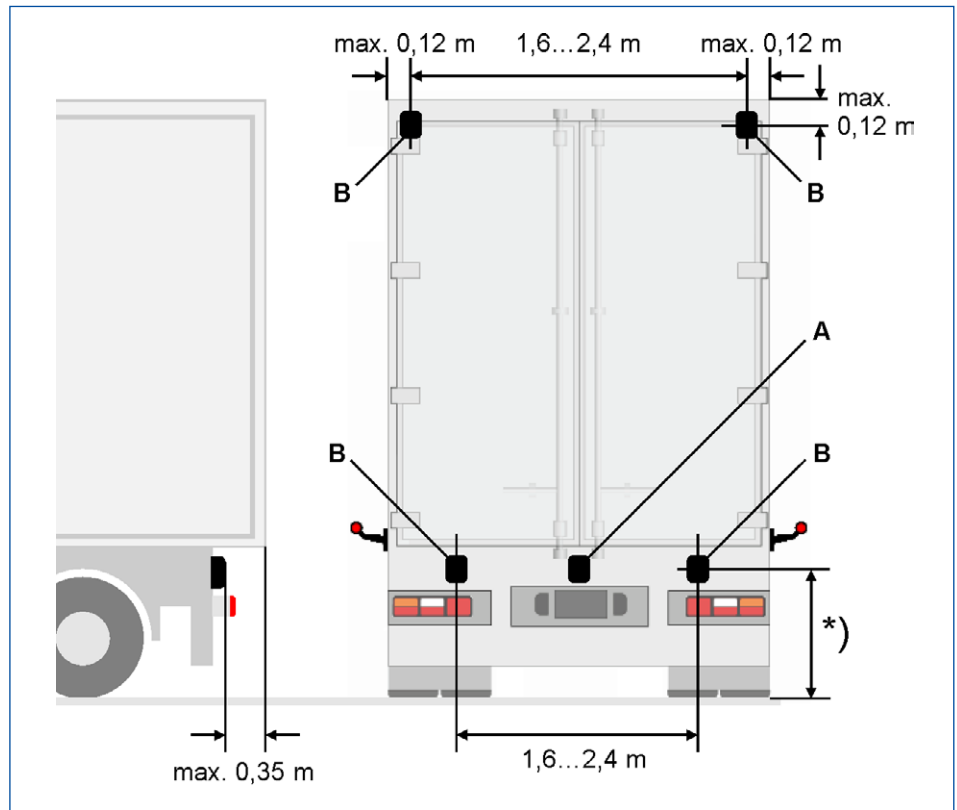

## LEGEND

<b>A</b>	LIN ultrasonic sensor 0° 446 122 401 0 horizontal or vertical
<b>B</b>	LIN ultrasonic sensor 15° 446 122 402 0 / 446 122 404 0 or LIN ultrasonic sensor 0° 446 122 401 0 (upper level only)

Please observe the table on installation for LIN ultrasonic sensor alignment:

### Installing the LIN ultrasonic sensors

	FROM VERSION TEBS E2 AND ELECTRONIC EXTENSION MODULE 0	FROM VERSION TEBS E2.5 AND ELECTRONIC EXTENSION MODULE 1
Upper (additional level)	Outside 446 122 402 0 / 446 122 404 0 – 15° vertical	Outside 446 122 402 0 / 446 122 404 0 – 15° vertical
Lower (main level)	Outside 446 122 402 0 / 446 122 404 0 – 15° vertical	Outside 446 122 402 0 / 446 122 404 0 – 15° vertical
	Inside 446 122 401 0 – 0° vertical	Inside 446 122 401 0 – 0° horizontal
	Installation height 0.4...1.2 m ( ▶ illustration "TailGUARD™ installation dimensions")	Installation height 0.8...1.2 m ( ▶ illustration "TailGUARD™ installation dimensions")

TEBS E2.5

More installation alternatives are possible based on the TEBS E diagnostic software.



# Installation notes for vehicle construction and retrofitting

## System configuration – TailGUARD<sup>Roof</sup>™

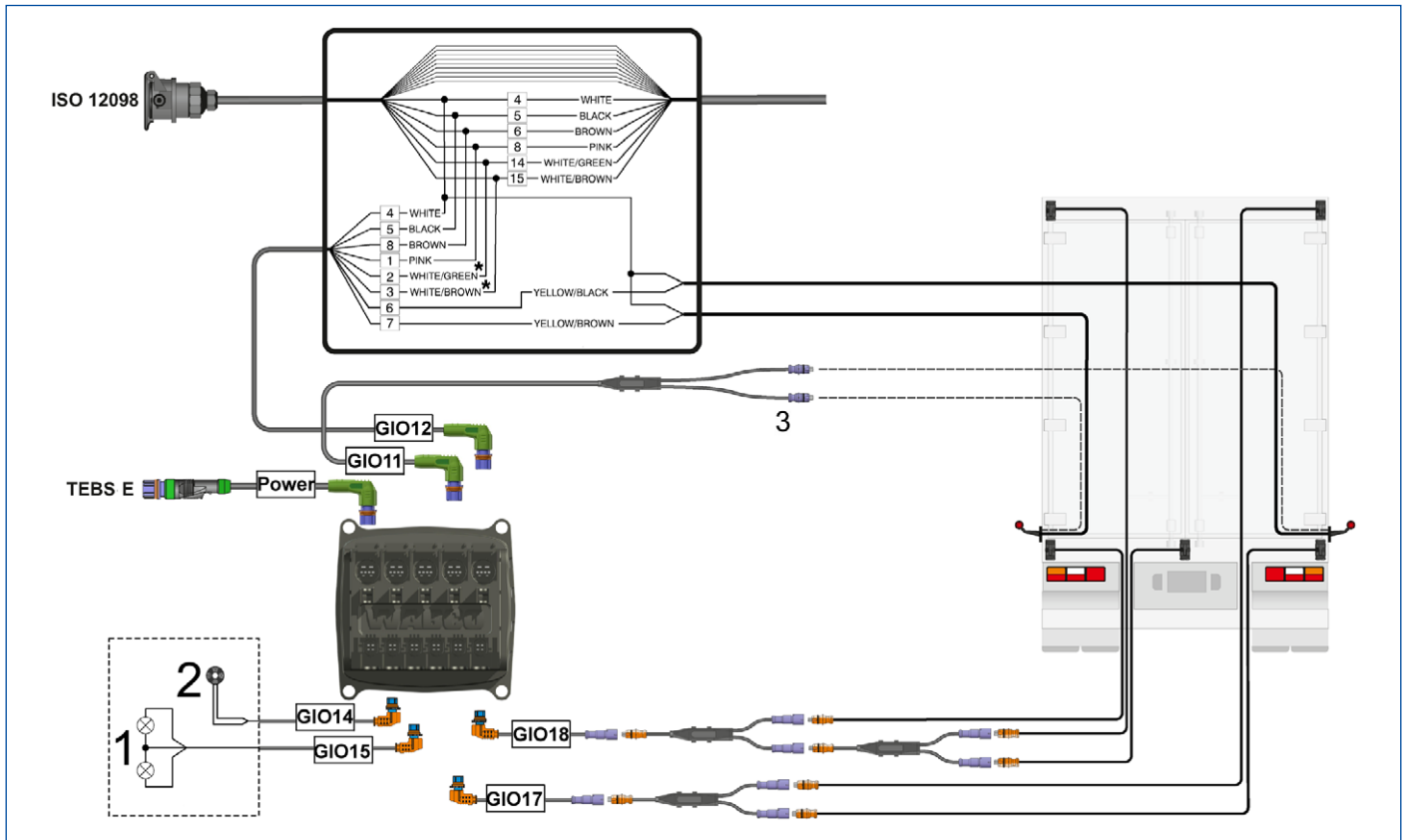

### LEGEND

1	External lights (optional)
2	Buzzer (optional)
3	Distributor 894 600 024 0
*	CAN communication to towing vehicle (optional)
<b>GIO11</b>	Cable for clearance lights 449 803 022 0
<b>GIO12</b>	Universal cable 449 908 060 0; alternatively: Aspöck cable 65-6111-007
<b>GIO14, GIO15</b>	Universal cable 449 535 XXX 0 (4-pole, open)
<b>GIO17, GIO18</b>	Cable for LIN ultrasonic sensor 449 806 060 0
<b>POWER</b>	Power supply cable for electronic extension module 449 303 020 0

Wiring concept for junction box (function and colour table) ▶ chapter "7.1.2 Connecting ISO 12098", page 140.  
Schematic diagram 841 802 283 0 ▶ chapter "12.4 GIO schematic diagrams", page 218.

# Installation notes for vehicle construction and retrofitting

## TailGUARDMAX™

- Mount 6 LIN ultrasonic sensors vertically in two levels.
  - Only if the 6 LIN ultrasonic sensors are mounted on the vehicle in the arrangement shown in the following will the system meet all requirements of ISO 12155 (Obstacle detection device during reversing).

Both levels follow the same install guidelines:

- Mount the outside LIN ultrasonic sensors 446 122 402 0 / 446 122 404 0 (15°) inclined inwards.
- Mount the LIN ultrasonic sensor 446 122 401 0 (0°) centrally.
  - Distance LIN ultrasonic sensor 1 (left) – LIN ultrasonic sensor 2 (right):
    - The LIN ultrasonic sensors on the main level must be installed with spacing of 180 cm.
    - The main level must be installed at a height of 90 cm from the ground.
    - The additional level must be installed at a height of 40 cm from the ground.
  - A Trailer Remote Control must be installed in the driver's cab.

Note the following install dimensions:

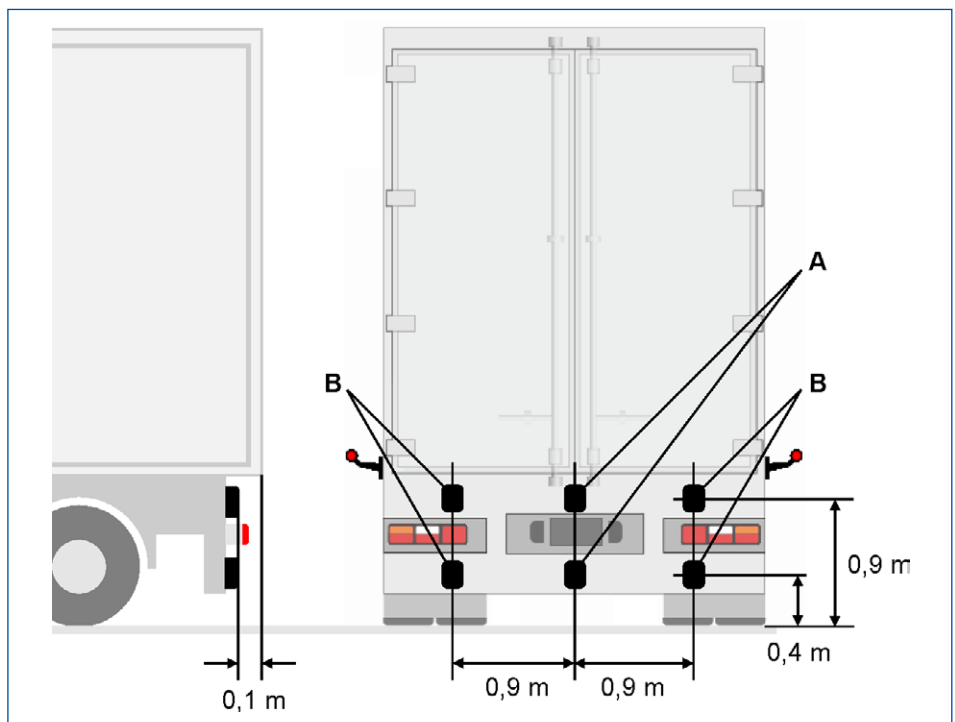

### LEGEND

<b>A</b>	LIN ultrasonic sensor 0° 446 122 401 0
<b>B</b>	LIN ultrasonic sensor 15° 446 122 402 0 / 446 122 404 0 <b>Do not install horizontally!</b>

# Installation notes for vehicle construction and retrofitting

Please observe the table on installation for LIN ultrasonic sensor alignment:

## Installing the LIN ultrasonic sensors

Top (main level)	446 122 402 0 / 446 122 404 0 – 15° vertical
	446 122 401 0 – 0° vertical
Bottom (additional level)	446 122 402 0 / 446 122 404 0 – 15° vertical
	446 122 401 0 – 0° vertical

## System configuration – TailGUARDMAX™

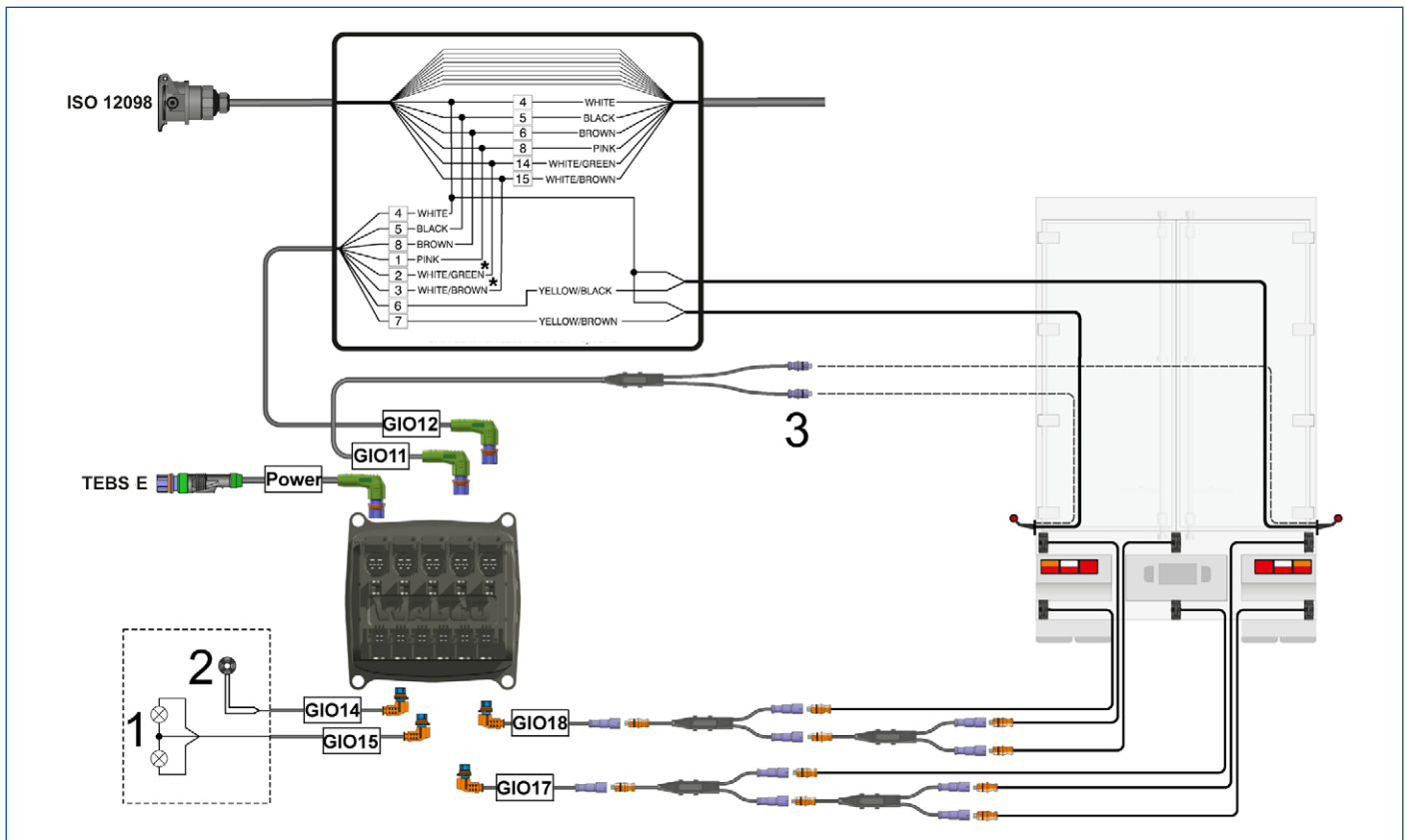

### LEGEND

1	External lights (optional)
2	Buzzer (optional)
3	Distributor 894 600 024 0
*	CAN communication to towing vehicle (optional)
<b>GIO11</b>	Cable for clearance lights 449 803 022 0
<b>GIO12</b>	Universal cable 449 908 060 0; alternatively: Aspöck cable 65-6111-007
<b>GIO14, GIO15</b>	Universal cable 449 535 XXX 0 (4-pole, open)
<b>GIO17, GIO18</b>	Cable for LIN ultrasonic sensor 449 806 060 0
<b>POWER</b>	Power supply cable for electronic extension module 449 303 020 0

Wiring concept for junction box (function and colour table) ▶ chapter "7.1.2 Connecting ISO 12098", page 140.  
Schematic diagram 841 802 282 0 ▶ chapter "12.4 GIO schematic diagrams", page 218.

## 8.10 Installing eTASC

### Assembly

- ! Installing eTASC is similar to installing TASC.
- A precise description can be found in the publication "TASC – Function and Assembly", ▶ chapter "2 General information", page 7 => section "Technical documents".

Mounting is compatible with TASC and the standard rotary slide valves. In the event of space problems, the eTASC device can be turned in 90° steps for an ideal position. The device is installed turned accordingly, and the handle is removed and mounted so that it points downwards to the "Stop" position.

Size  $\varnothing$  12x1.5 mm is recommended for connected lines and piping for optimum lifting and lowering times.

If the cross-section of the lines and piping between the eTASC and the air bags is too small or the length of the lines is too long, the Trailer EBS E may not correctly identify the manual actuation of the eTASC.

Recommended piping diameters and lengths are shown in the table below.

- ! The Trailer EBS E pressure sensor for detecting the axle load (connection 5) must be connected via a T-piece when installing between the eTASC and the first bellows supplied with air pressure.

When using a star-formed connection for the bellows, the pressure sensor connection is to be made directly to the distributor.

#### Piping diameter and lengths

CONNECTION	NUMBER OF CIRCUITS	PIPE DIAMETER [mm]; PIPE LENGTH [m]	
		MINIMUM	RECOMMENDED
PEM => eTASC (supply line)	2	$\varnothing$ 8x1 mm; max. 6 m	$\varnothing$ 12x1,5 mm; max. 8 m
eTASC => bellows	2	$\varnothing$ 8x1 mm; max. 6 m	$\varnothing$ 12x1,5 mm; max. 8 m
Bellow => bellow	2	$\varnothing$ 8x1 mm; max. 4 m	$\varnothing$ 12x1,5 mm; max. 5 m
Venting	2	–	$\varnothing$ 12x1,5 mm; max. 1 m
PEM => eTASC (supply line)	1	$\varnothing$ 12x1,5 mm; max. 8 m	$\varnothing$ 12x1,5 mm; max. 8 m
eTASC => Distributor	1	$\varnothing$ 12x1,5 mm; max. 6 m	$\varnothing$ 12x1,5 mm; max. 6 m
Distributor => Bellow	1	$\varnothing$ 8x1 mm; max. 4 m	$\varnothing$ 12x1,5 mm; max. 5 m
Bellow => bellow	1	$\varnothing$ 8x1 mm; max. 4 m	$\varnothing$ 12x1,5 mm; max. 5 m

## 9 Start-up

### Start-up procedure

1. Brake calculation
2. Parameter setting in TEBS E diagnostic software
3. Functional test (EOL test)
4. Calibration
5. Documentation

### 9.1 Brake calculation

A brake calculation can be conducted by WABCO (charges apply). Speak to your WABCO partner.

### 9.2 Parameter setting in TEBS E diagnostic software

#### Introduction

WABCO offers TEBS E as a universal system that must be adjusted to the respective vehicle type by means of parameters. TEBS E cannot function without such a configuration.

The parameters are configured using the TEBS E diagnostic software.

For series production of vehicles, prepared parameter sets can be copied into the TEBS E.

Please note that new modulators respectively require the most recent version of the TEBS E diagnostic software.

User guidance in the TEBS E diagnostic software is based on the required configuration steps. Operation of the program is self-explanatory and additionally there is a comprehensive help system within the software.



The parameter configuration is launched from the *Start-up* menu. Applications and functions are logically grouped on the different screens which are easily opened using tabs. Settings are defined by clicking option fields, selecting text fields or entering numbers.

The tab *Connectors* on the right-hand side of the screen allows assigning GIO functions to the different GIO slots.

If more GIO functions are required than the number of slots available on the TEBS E, the TEBS E Premium Modulator must be used in combination with the electronic extension module.

There are 7 parameter-definable connections (GIO1 to GIO7) on the TEBS E Modulator and 4 parameter-definable connections (GIO13 to GIO16) on the electronic extension module.

Standard configurations have been defined to facilitate the process of setting parameters and GIO port assignments for standard applications, ▶ chapter "12.4 GIO schematic diagrams", page 218. These standard configurations show the maximum possible connection to the TEBS E Modulator – from a simple semitrailer with the RtR function up to the ECAS function with unloading level switch, road finisher brake, etc.

If a new parameter set is to be created for a vehicle, a suitable GIO plan is selected first. The respective parameter set suitable for this is stored in the TEBS E diagnostic software (under the GIO diagram number).

The TEBS E Modulator pin assignments are defined in the GIO plans for the Standard and Premium variant respectively. The respective maximum systems are described in the plans and parameter records.

If the functions are not required, they can simply be deselected in the selection of functions.

## Offline Parameter setting

Defining a parameter set directly on the vehicle is easier because the type of the connected TEBS E Modulator is recognised automatically. However, a parameter set can also be prepared without a vehicle and stored on the PC for later use.

## Requirements for parameter setting

TEBS E system training is necessary to create a parameter set.

Only after receiving the PIN are you authorised to make changes using the TEBS E diagnostic software, ▶ chapter "11.2 System training and PIN", page 194.

### TEBS E2

There is a new PIN from TEBS E2, therefore another training course is required. Speak to your WABCO partner.



### Ordering the TEBS E diagnostic software

- Open the myWABCO website:  
<http://www.wabco-auto.com/en/aftermarket-services/mywabco/>

Help on logging in can be obtained by pressing the *Step-by-step instructions* button.

After you have successfully logged in, you can order the TEBS E diagnostic software via myWABCO.

Please contact your WABCO partner if you have any questions.

- Have the data from the brake calculation and the GIO diagram number ready for the parameter setting.
- Open the TEBS E diagnostic software.
  - ⇒ The start window is opened.

### What's new in the TEBS E diagnostic software?

- Click Help => Contents => What's new?

Click on the software version for which you want to read about innovations.

## 9.3 Functional test

Setting the parameters is usually followed by the functional test:

You can only perform the function test (EOL test) if you have taken part in the TEBS E training course.

You can use the TEBS E diagnostic software to carry out various simulations via the *Actuation* menu.

## 9.4 Start-up of the LIN ultrasonic sensors

---

! PWM ultrasonic sensors (TailGUARDlight™) are not taught.

■ Reflections cannot be masked out.

---

Requirement: For start-up of the ultrasonic sensors and TailGUARD™ system, reverse gear must be engaged.

### Normal EOL test

Initialisation of the LIN ultrasonic sensors is carried out in three steps as part of the end-of-line test:

1. Teaching the LIN ultrasonic sensors
2. Reflection test
3. Test body detection

#### 1. Teaching the LIN ultrasonic sensors

The LIN ultrasonic sensors must be taught to detect the position on the vehicle after installing.

- In the TEBS E diagnostic software, click *Measured values, TailGUARD*.
- Go to window *TailGUARD* and click on button *Start initial start-up*.
  - This requires covering the LIN ultrasonic sensors for 1-2 seconds each, the following sequence must be strictly followed:  
Main level: 1-left 2-right 3-middle  
Additional level: 4-left 5-right 6-middle
  - ⇒ The LIN ultrasonic sensor to be covered flashes.
  - ⇒ If an LIN ultrasonic sensor has been detected, the position lamps of the vehicle flash one time and the next LIN ultrasonic sensor that has to be taught flashes in the image ( ▶ window *TailGUARD*).

#### 2. Reflection test

After the LIN ultrasonic sensors are taught, a test is performed to find whether reflections occur and the LIN ultrasonic sensors incorrectly detect objects on the vehicle as hindrances.

- For this test, an area of 2.5 m behind the vehicle and 0.5 m to the side of the vehicle must be kept clear.
- If an object is detected, press the *Mask reflections* button to mask this reflection out.
  - ⇒ Another measurement is then made to determine whether reflections of other objects have to be masked.

- ⇒ If objects are still detected, LIN ultrasonic sensors or attachment parts must be positioned differently.

### 3. Test body detection

If the system is fault-free, an object test is performed.

- This requires a test specimen, e.g. a plastic pipe, which is higher than the installation height of the LIN ultrasonic sensors, at 0.6 m left ( $\pm 0.1$  m) and 1.6 m right ( $\pm 0.2$  m) in the area behind the vehicle.
  - ⇒ The detected distance is shown in the TEBS E diagnostic software.
- Confirm the position of the objects with button *Object detected*.
  - ⇒ If the test specimen is detected properly, the End-of-Line bit in the electronic extension module is deleted and the system is fault-free. The start-up was successful.
  - ⇒ If the test was not successful, either the LIN ultrasonic sensors are being taught in the wrong position or the parameters for the sensor distance have been entered improperly.
    - Check the parameters or the installation position of the LIN ultrasonic sensors and repeat the test.

## Reduced EOL test

### TEBS E2.5

As of version TEBS E2.5 there is the option of reducing the EOL test. The following conditions must be met for this:

- The setting for the TailGUARD™ test *Object test (optional)* must be deselected under *Options, Settings, Test options*.
- The distance between the left and right LIN ultrasonic sensors is 1.6 - 2.4 m.
- With three LIN ultrasonic sensors the middle LIN ultrasonic sensor must be positioned centrally. A deviation of 30 cm to the left or right of the central axis is permitted.
- The maximum installation depth of the LIN ultrasonic sensors is 35 cm.

If all the conditions are met, the initialisation process changes:

- Confirm the installation dimensions that were defined with the parameters.
  - ⇒ Only then can the initialisation be reduced using the *Distances correct, skip object test* button.
- Continue as described under section "Teaching the LIN ultrasonic sensors".
  - Additionally with three LIN ultrasonic sensors at the main level: After the last LIN ultrasonic sensor has been learned, the position lamps are illuminated for 3 seconds.
- The position of the middle LIN ultrasonic sensor must then be confirmed by keeping it held again.
  - The position lamps must be out.
  - If one of these conditions is not met, the normal EOL test must be carried out.



## Echo test

Finally, the echo test is carried out.

- Keep free an area of 2.5 m behind and 0.5 m at the side of the vehicle.
- If an object is detected, press the *Mask reflections* button to mask this reflection out ( ▶ section "Normal EOL test - Test for reflections").

The reflection test can be omitted for the EOL test if the following conditions apply:

- The reflection test was previously carried out successfully at least once.
- The structure of the vehicle's rear, i.e. the installation position of the ultrasonic sensors, buffer, etc. is still identical.
- A stable and series production with reliable processes is being used.

The reflection test can also be deselected via Options and Settings. However, this is only recommended for standardised vehicles whose values are known and where the reflection test has been carried out once.

After carrying out the test for the first time, the interference echo values must be written to a file (only where interference echoes are found). The content of this file should be added to the ECU file for the next vehicle.

When you start configuring with a modified ECU file, a dialogue appears asking whether the values in the ECU file should be used. This is permitted only for vehicles with the same TailGUARD™ configuration and identical installation scenario.

In the case of new vehicles or changed installation conditions (e.g. more or differently arranged external components on the trailer rear), the reflection test must not be deselected.

## 9.5 Calibrate the height sensors

---

**!** For calibrating the height sensors, TEBS E system training or a successfully completed E-Learning course is mandatory.

Only after obtaining the PIN 2 are you authorised to perform the calibration, ▶ chapter "11.2 System training and PIN", page 194.

---

### Prerequisites for a successful calibration

- The characteristic curve range is 966 - 1660 timer ticks (TT).
- Driving level I must be between 1139 and 1486 TT.
- The upper calibration level must be greater than the sum of driving level I (Normal level) and 3x the tolerance value for the nominal level (can be set with the TEBS E diagnostic software) + 5 mm (e.g. arresting cable).
- Upper calibration level > driving level + 3x tolerance value of nominal level + 5 mm
- The lower calibration level value must be less than the difference of the driving level minus 2 times the nominal level tolerance.  
Lower calibration level < driving level - 2x tolerance value of nominal level

---

**!** Restricting cables are attached around the axles so that the body cannot be lifted too far, in order to limit the maximum height.

---

A characteristic curve error appears in the diagnostic memory in the event of an implausible calibration.

- Move the vehicle into a horizontal position at the height of normal level before starting the calibration.

## 3-point calibration

Usage: for individual calibration of a vehicle.

This type of calibration corresponds to the standard ECAS systems.

- Press the button *Start calibration (System, Calibrate distance sensors)*.



- Adjust the vehicle to normal level I using the Lifting / Lowering buttons.
- Press the *Save normal level* button.
  - ⇒ An input field appears into which the distance between the load floor or the top edge of the vehicle frame at normal level I relative to the road is entered (in mm). Always measure the distance in the vicinity of the axle to be calibrated.
- Adjust the vehicle to the upper level using the Lifting / Lowering buttons.
- Press the *Save upper level* button.
  - ⇒ An input field appears into which the distance between the load floor or the top edge of the vehicle frame at upper level relative to the road is entered (in mm).
- Adjust the vehicle to the lower level using the Lifting / Lowering buttons.
- Press the *Save lower level* button.
  - ⇒ An input field appears into which the distance between the load floor or the top edge of the vehicle frame at lower level relative to the road is entered (in mm).
  - ⇒ If the calibration was successful, a corresponding message appears.
  - ⇒ If the calibration failed, proceed as follows:
    - Check the attachment of the height sensor.
    - Change the lever length if necessary.
    - Adjust the upper/lower level.
    - Then repeat the calibration.

## Calibration "Input of mechanical values"

Usage: For calibration of vehicles of the same type (series)

For this mode of calibration only the length of the lever on the ECAS height sensor is entered (between fulcrum point height sensor and anchor point linkage) and the distance to the upper and lower level in mm relative to normal level I. The value "Angle of rotation / compression travel" is calculated automatically. Then normal level I needs to be calibrated.

- Press the *Start calibration* button.
- Enter the lever length between "height sensor" fulcrum and anchor point of the "linkage".
- Enter the deflection to upper and lower level.

- Enter the vehicle height (height of the load surface or height of the upper edge of the vehicle frame).
- Confirm with OK.
- Adjust the vehicle to normal level I using the Lifting / Lowering buttons.
- Press the *Save normal level* button.
  - ⇒ If the calibration was successful, a corresponding message appears.
  - ⇒ If the calibration failed, proceed as follows:
    - Check the attachment of the height sensor.
    - Change the lever length if necessary.
    - Adjust the upper/lower level.
    - Then repeat the calibration.

## Calibration "Load calibration data from file"

Application: Recommended for large series

Calibration data is determined using a sample vehicle and saved with *Write calibration data to file*. Data can be saved directly to a \*.ECU parameter file. This data is then read out during the calibration and written to the ECU. A separate adjustment to the level is not required.

The prerequisite for this is that the position of the height sensor, the lever length as well as the length of the linkage to the axle are identical in all vehicles.

- Press the *Start calibration* button.
- Choose *Load calibration data from file* from the file window.
  - ⇒ If the calibration was successful, a corresponding message appears.
- After completing the calibration of the 1st axle, repeat the calibration procedure for the 2nd axle.

## 9.5.1 Calibration for vehicles with mechanical suspension

In the case of vehicles with mechanical suspension, the height sensor must be calibrated.

- Check in advance that the lever length of the height sensor is 100 mm and that the vehicle is unladen.
- Enable *Mechanical suspension* in the TEBS E diagnostic software in *tab 2, Vehicle*.
  - The unladen vehicle is defined with compression travel 0 mm (no entry necessary).
- After selecting the type of suspension, enter Suspension path laden [mm] and 100 mm for the *Height sensor lever length [mm]*.
- Click *Calibrate distance sensors for axle load* to perform the calibration for the unladen vehicle.
- Enter the current axle load of the axle in field *Current axle load for axle c-d*.
- Click on button *Calibrate distance sensor axle c-d*.
  - ⇒ If the calibration was successful, a corresponding message appears.
  - ⇒ If the calibration failed, proceed as follows:
    - Check the attachment of the height sensor.
    - Change the lever length if necessary.
    - Then repeat the calibration.

## 9.6 Documentation

### System label

After the TEBS E system has been installed, the TEBS E diagnostic software can be used to create a TEBS E system label documenting the setup data.

This TEBS E system label must be affixed in a clearly visible place on the vehicle (e. g. in the area where the LSV plate is located in conventional braked vehicles).

WABCO		TRAILER EBS-E		GGVSAOR TUEH TB 2007 - 019.00	
<b>WABCO</b> WABCO Sattelanhänger 1234567890 WDE123456 100 100 4S/2M X		GIO Pin1 Pin3 Pin4 1 SA-SW --- --- 2 --- --- --- 3 --- --- --- 4 --- --- --- 5 DIAG DIAG DIAG 6 --- --- --- 7 --- --- ---		7 6	
Subsystems SB I/O 24N		8			
pm (bar) 6.5 1 2000 0.4 2.0 9000 5.0 0.4 2.0 --- 6.5 2 2000 0.4 2.0 9000 5.0 0.4 2.0 --- 6.5		pm (bar) 0.7 2.0 --- 6.5 3 0 --- --- 0 --- --- --- --- --- 4 0 --- --- 0 --- --- --- --- --- 5 0 --- --- 0 --- --- --- --- ---		(bar) 1.0 Pz TR (daN) 16 68 88 550 3950 36 / 30 68 68 540 2540	
1		2		3	
				4	
				5	

LEGEND	
1	Unladen vehicle
2	Laden vehicle
3	1st lifting axle
4	Data Brake cylinder
5	Reference values
6	Ride height
7	Selected pin assignments to the GIO slot
8	IN/OUT connections

The blank foil for this type plate can be obtained via WABCO part number 899 200 922 4.

The data must be printed out using a laser printer.

### Printing PDF files

#### TEBS E2

A print-out of the start-up log and the diagnosis memory protocol can be created as a PDF directly from the print menu with the TEBS E diagnostic software (from version TEBS E2).

## 10 Operation

### 10.1 Warning messages

Information about warning messages:

- in the corresponding function descriptions
  - ▶ chapter "6 GIO functions", page 59.
- ▶ chapter "5.8.1 Warnings and system messages", page 35.

### 10.2 Operation with the Trailer Remote Control

! The Trailer Remote Control only allows functions that have been predefined, using the TEBS E diagnostic software, in the TEBS E Modulator (**from version TEBS E2**) for the trailer ( ▶ "Configuration" section).



For further information on operation, please also refer to "Trailer Remote Control – Operating Instructions (non-verbal)", ▶ chapter "Technical documents", page 8.

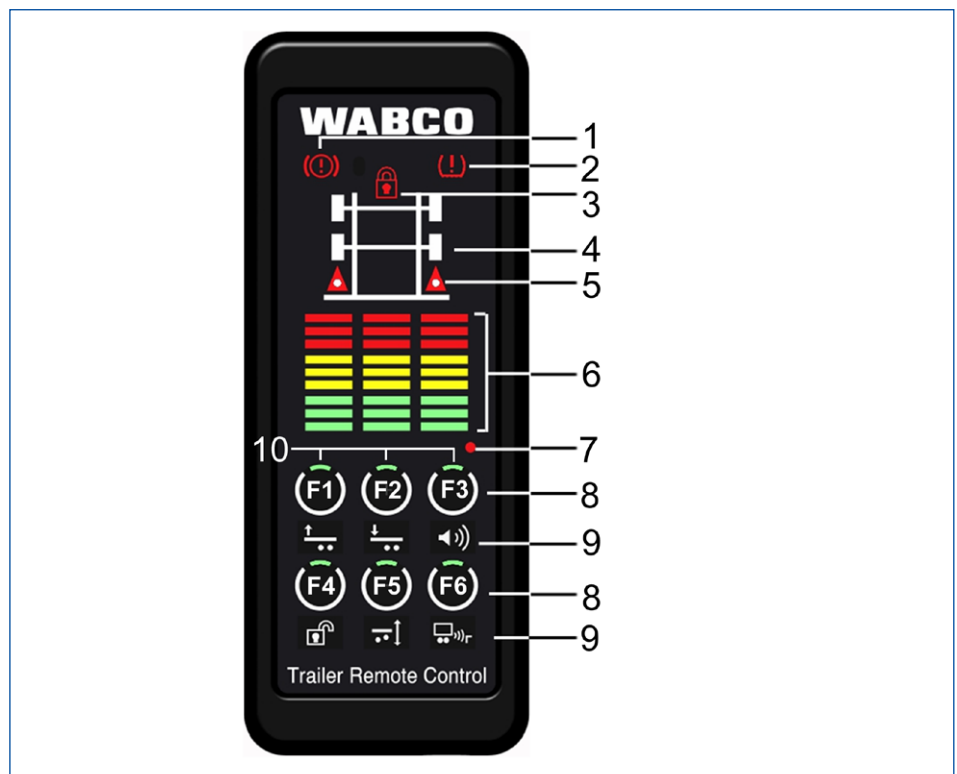





#### Description of the Trailer Remote Control user interface





ITEM	DESIGNATION
1	Warning indicator for brake lining: Symbol is continuously illuminated with low brake lining if the lining wear sensing is installed in the trailer.
2	Warning indicator for tire pressure: Symbol is continuously illuminated if the tire pressure is low when OptiTire™ is installed in the trailer.

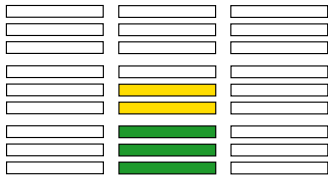
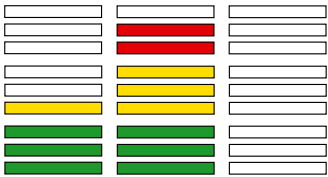

ITEM	DESIGNATION
3	LED for the immobilizer: Symbol flashes (1 Hz) if the vehicle is immobilized.
4	Trailer symbol
5	LEDs for reverse gear: Symbols are illuminated if reverse gear is engaged.
6	LED rows for TRAILERGUARD™: The 3 LED rows indicate whether and where an object is behind the vehicle if the TailGUARD™ system is active.
7	Button press confirmation
8	Configurable buttons for activating/deactivating functions: The 6 function buttons can be allocated with the functions ▶ chapter "6 GIO functions", page 59.
9	Changeable symbols depending on button programming
10	Activation confirmation for the function, with green illumination of the upper part of the ring

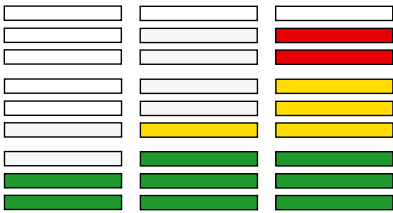

BUTTON SYMBOL	FUNCTION
	<p><b>Traction help</b>            Activates the traction help: Touch the button &lt; 5 seconds.            Activates the "off-road" traction help (if defined): Touch button 2 times.            Deactivates the traction help / "off-road" traction help: Automatically when the driving speed configured in the TEBS E is exceeded.</p> <p><b>Forced lowering</b>            Activation: Touch the button &gt; 5 seconds.            Deactivation: Switch on the ignition again or touch the button again.            When touching the button, the traction help is activated again.</p>
	<p>If OptiLoad™ and OptiTurn™ have not been configured as Automatic:</p> <p><b>Manoeuvring assistance (OptiTurn™)</b>            Activation: Touch the button &lt; 5 seconds.            Deactivation: Automatic when the driving speed configured in the TEBS E is exceeded.</p> <p><b>Drawbar load reduction (OptiLoad™)</b>            Activation: Touch button 2x (if Automatic has not been set in advance).            Deactivation: Automatic when the driving speed configured in the TEBS E is exceeded.</p> <p><b>Forced lowering</b>            Activation: Touch the button &gt; 5 seconds.            Deactivation: Switch on the ignition again or touch the button again.            OptiTurn™ is activated again when the button is touched.</p>
	<p><b>Driving level II</b>            Activating normal level II: Touch button.</p> <p><b>Driving level I</b>            Activation of driving level I: Touch button again.            Back to driving level II: Touch button 2 times.</p>







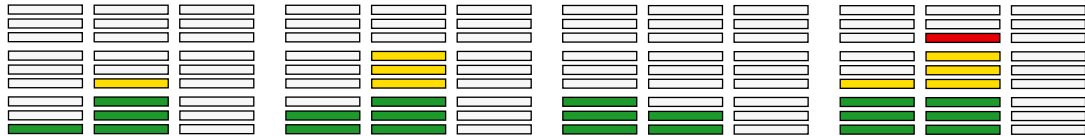





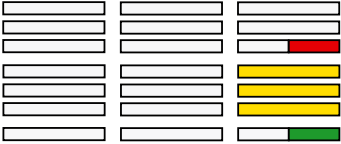





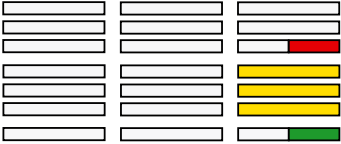

BUTTON SYMBOL	FUNCTION
	<p><b>Forced lowering</b>            Activation: Touch button (or "Manoeuvring assistance" button or "Traction help" button for &gt; 5 seconds).            Deactivating the function "Forced lowering" and simultaneously activating the lifting axle control (lifting the lifting axle depending on the load): Touch button again.</p>
	<p><b>ECAS lifting</b>            Activation: Touch button.            Prior to version 1 of the electronic extension module, Lifting/Lowering must be selected as the GIO function and allocated in the GIO connector assignment.</p>
	<p><b>ECAS lowering</b>            Activation: Touch button.            Prior to version 1 of the electronic extension module, Lifting/Lowering must be selected as the GIO function and allocated in the GIO connector assignment.</p>
	<p><b>Tilt angle display</b>            Activation: Touch button (green LEDs are lit permanently).            Deactivation: Touch any button (green LEDs go completely off).            The parameters for the warning levels can be set in the TEBS E diagnostic software.            Green display (lit permanently): Tilt angle less than warning level 1, no danger.            Yellow display (lighting permanently, alert 1 Hz): Tilt angle between warning level 1 and 2, Attention!            Red display (flashing 2 Hz, continuous tone): Warning level 2 exceeded, Danger! Cancel lifting the dumper body immediately.</p>
	<p><b>Unloading level</b>            Activation: Touch button.            Activate previous level: Touch button again.</p>
	<p><b>Road finisher brake</b>            Activation: Touch button.            Deactivation: Touch the button again or automatic if the vehicle speed is &gt; 10 km/h.            Call up menu "Settings": Touch the button &gt; 2 seconds.            The braking pressure can be set in 0.1 bar steps with the +/- button (F2 &amp; F5); values between 0.5 and 6.5 bar are possible.            The availability of the +/- functionality on buttons F2 and F5 is indicated by the upper part of the ring flashing in green.            The actual situation is displayed when the function is switched on. The values for the TEBS E integrated pressure sensor are shown and can be adjusted directly. The display is in the 1st and 2nd columns of the LED rows. The 1st column shows the whole-number pressure value while the 2nd column shows the decimal place.</p> <div style="display: flex; justify-content: space-around; align-items: flex-start;"> <div style="text-align: center;"> <p>0,5 bar</p>  <p>0      5</p> </div> <div style="text-align: center;"> <p>4,8 bar</p>  <p>4      8</p> </div> </div> <p>Exiting menu "Settings": Touch button &gt; 2 seconds or if no button is touched &gt; 5 seconds.</p>

BUTTON SYMBOL	FUNCTION
	<p><b>Axle load indicator (from electronic extension module 1)</b>            Activation: Touch button.            A "T" appears (total mass), after 2 seconds the total mass is displayed:            In the left-hand column, one LED corresponds to 10,000 kg mass respectively.            In the middle column, one LED corresponds to 1,000 kg mass respectively.            In the right-hand column, one LED corresponds to 100 kg mass respectively.</p>  <p>Example: <math>2 \times 10,000 \text{ kg} + 4 \times 1,000 \text{ kg} + 8 \times 100 \text{ kg} = 24,800 \text{ kg}</math>            The +/- buttons can be pressed to switch to any axle and display its load.            Pressing the +/- button once will display the currently selected axle:            "T" = total mass, "1" = axle 1, "2" = axle 2, etc.            Pressing the +/- button again will select the desired axle.            The selected axle is indicated for 2 seconds before the load on this axle is shown automatically by the LED rows.            The TEBS E diagnostic software can be used to define the maximum permissible axle loads.            If the permissible axle load for one axle or the permissible total load is exceeded, the system automatically switches to the axle with the overload and shows its load.            While an overload condition is detected, the display flashes and a warning tone is output which can be deactivated by pressing a button.            Deactivation: Touch button again.            The axle load can therefore only be measured if the vehicle is not under tension (relieve chassis/suspension by releasing the brake, then reapply the brake).            The measurement may be inaccurate if the vehicle is not at driving level.</p> <p><b>Notes:</b>            The axle loads are determined through the bellows pressures. Their accuracy therefore depends on the LSV values parameterised for axle load and bellows pressure.            If the axles are under tension, the bellows pressures do not reflect the actual axle load (tensioned axles: when the wheels want to turn, but can't because they are being braked).            The axle load can therefore only be measured if the vehicle is not under tension (relieve chassis/suspension by releasing the brake, then reapply the brake).            The measurement may be inaccurate if the vehicle is not at driving level.</p>
	<p><b>OptiTurn™ automatic off (electronic version extension module 1)</b>            Activation: Touch button.            Temporary deactivation (to prevent automatic starting): Touch button again.            Continuous deactivation: Touch the button &gt; 5 seconds.            To switch the function off permanently, i.e. even after restarting the ignition, the button must be pressed for 5 seconds. The same applies for switching it on.            Select <i>Activate OptiTurn™/OptiLoad™ with SmartBoard (no switch necessary)</i> in the TEBS E diagnostic software to activate the function in the Trailer Remote Control without having to allocate a switch in the GIO connector assignment.</p>

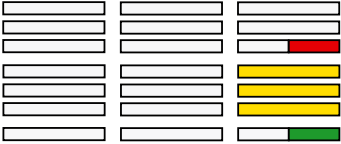

BUTTON SYMBOL	FUNCTION																																																																
	<p><b>OptiLoad™ automatic off (electronic version extension module 1)</b>            Activation: Touch button.            Temporary deactivation (to prevent automatic starting): Touch button again.            Continuous deactivation: Touch the button &gt; 5 seconds.            To switch the function off permanently, i.e. even after restarting the ignition, the button must be pressed for 5 seconds. The same applies for switching it on.            Select <i>Activate OptiTurn™/OptiLoad™ with SmartBoard (no switch necessary)</i> in the TEBS E diagnostic software to activate the function in the Trailer Remote Control without having to allocate a switch in the GIO connector assignment.</p>																																																																
	<p><b>Roll Stability Adviser (from electronic extension module version 1 – only in combination with RSS function activated in TEBS E)</b>            The lateral acceleration of the trailer is indicated by the LEDs.            If the lateral acceleration exceeds 35 % of the critical value, the three-LED row lights up.            The additional LEDs are switched on at the following critical lateral accelerations:</p> <ul style="list-style-type: none"> <li>• 4th LED row yellow = 35 %</li> <li>• 5th LED row yellow = 55 %</li> <li>• 6th LED row yellow = 75 % plus advance warning tone</li> <li>• 7th LED row red = 95 % and continuous warning tone</li> </ul> <p>If the communication between the electronic extension module in the trailer and the Trailer Remote Control in the towing vehicle is faulty, a warning tone is signalled for 3 seconds and the central red and central yellow row of LEDs light up.</p> <table border="0" data-bbox="371 1099 1329 1355"> <tr> <td style="text-align: center;">Left-hand bend</td> <td style="text-align: center;">Right-hand bend</td> </tr> <tr> <td style="text-align: center;"> <table border="1" data-bbox="371 1144 767 1355"> <tr><td> </td><td> </td><td> </td></tr> <tr><td> </td><td> </td><td> </td></tr> <tr><td> </td><td> </td><td> </td></tr> <tr><td> </td><td> </td><td> </td></tr> <tr><td> </td><td> </td><td> </td></tr> <tr><td> </td><td> </td><td> </td></tr> <tr><td> </td><td> </td><td> </td></tr> <tr><td> </td><td> </td><td> </td></tr> <tr><td> </td><td> </td><td> </td></tr> <tr><td> </td><td> </td><td> </td></tr> </table> </td> <td style="text-align: center;"> <table border="1" data-bbox="940 1144 1329 1355"> <tr><td> </td><td> </td><td> </td></tr> <tr><td> </td><td> </td><td> </td></tr> <tr><td> </td><td> </td><td> </td></tr> <tr><td> </td><td> </td><td> </td></tr> <tr><td> </td><td> </td><td> </td></tr> <tr><td> </td><td> </td><td> </td></tr> <tr><td> </td><td> </td><td> </td></tr> <tr><td> </td><td> </td><td> </td></tr> <tr><td> </td><td> </td><td> </td></tr> <tr><td> </td><td> </td><td> </td></tr> </table> </td> </tr> </table> <p>Automatic activation from a speed of 12 km/h            Switching off the warning tone: Touch button            Deactivating the function (until the next reset): Touch button again.            Activation of the function and the warning tone: Touch button again.            Continuous activation/deactivation: Press button at a speed above 12 km/h for at least 2 seconds.</p>	Left-hand bend	Right-hand bend	<table border="1" data-bbox="371 1144 767 1355"> <tr><td> </td><td> </td><td> </td></tr> <tr><td> </td><td> </td><td> </td></tr> <tr><td> </td><td> </td><td> </td></tr> <tr><td> </td><td> </td><td> </td></tr> <tr><td> </td><td> </td><td> </td></tr> <tr><td> </td><td> </td><td> </td></tr> <tr><td> </td><td> </td><td> </td></tr> <tr><td> </td><td> </td><td> </td></tr> <tr><td> </td><td> </td><td> </td></tr> <tr><td> </td><td> </td><td> </td></tr> </table>																															<table border="1" data-bbox="940 1144 1329 1355"> <tr><td> </td><td> </td><td> </td></tr> <tr><td> </td><td> </td><td> </td></tr> <tr><td> </td><td> </td><td> </td></tr> <tr><td> </td><td> </td><td> </td></tr> <tr><td> </td><td> </td><td> </td></tr> <tr><td> </td><td> </td><td> </td></tr> <tr><td> </td><td> </td><td> </td></tr> <tr><td> </td><td> </td><td> </td></tr> <tr><td> </td><td> </td><td> </td></tr> <tr><td> </td><td> </td><td> </td></tr> </table>																														
Left-hand bend	Right-hand bend																																																																
<table border="1" data-bbox="371 1144 767 1355"> <tr><td> </td><td> </td><td> </td></tr> <tr><td> </td><td> </td><td> </td></tr> <tr><td> </td><td> </td><td> </td></tr> <tr><td> </td><td> </td><td> </td></tr> <tr><td> </td><td> </td><td> </td></tr> <tr><td> </td><td> </td><td> </td></tr> <tr><td> </td><td> </td><td> </td></tr> <tr><td> </td><td> </td><td> </td></tr> <tr><td> </td><td> </td><td> </td></tr> <tr><td> </td><td> </td><td> </td></tr> </table>																															<table border="1" data-bbox="940 1144 1329 1355"> <tr><td> </td><td> </td><td> </td></tr> <tr><td> </td><td> </td><td> </td></tr> <tr><td> </td><td> </td><td> </td></tr> <tr><td> </td><td> </td><td> </td></tr> <tr><td> </td><td> </td><td> </td></tr> <tr><td> </td><td> </td><td> </td></tr> <tr><td> </td><td> </td><td> </td></tr> <tr><td> </td><td> </td><td> </td></tr> <tr><td> </td><td> </td><td> </td></tr> <tr><td> </td><td> </td><td> </td></tr> </table>																																		
	<p><b>TailGUARD™</b>            Activation: Engage reverse gear.            Deactivating (including deactivating the automatic braking function, visual and acoustic warning): Touch button.            Override deactivation: Disengage reverse gear.            Activation by button is not possible.</p>																																																																

BUTTON SYMBOL	FUNCTION
	<p><b>Immobilizer</b>            When the immobilizer is activated, all other functions of the Trailer Remote Control are deactivated. The symbol for the immobilizer flashes.            Activation: Touch button.</p> <p><b>Deactivation / activation by PIN entry</b>            Requirement: Parking brake is activated (setting with a parameter, applies for deactivation)            Open PIN input mask: Touch the button &gt; 2 seconds.            Beep as confirmation.            The left LED row indicates which position of the PIN is changed.            Change positions: Touch F1 button.            In the middle LED row, the value of the number of the PIN is shown and is set with buttons F2 and F5.            After successfully entering the 4-digit PIN: Touch the button &gt; 2 seconds.            2 long beeps as confirmation and changing the immobilizer icon.</p> <p><b>Example: PIN input 4627</b></p>  <p>1. PIN no. 4      2. PIN no. 6      3. PIN no. 2      4. PIN no. 7</p> <p>Reasons for failed activation/deactivation (4 short beeps, immobilizer symbol remains unchanged):</p> <ul style="list-style-type: none"> <li>■ If no entry is made within 5 seconds or the F3 button is actuated, the PIN entry mask disappears – without saving.</li> <li>■ The parking brake is not engaged although the Parameter setting specifies that the immobilizer can only be released if the parking brake is activated.</li> </ul> <p>If the activation/deactivation of the immobilizer function is not possible because the PUK was requested or a technical fault exists, access to the PIN entry mask is not possible. Instead, an acoustic response occurs (4 short beeps).</p> <p><b>Activation/deactivation with stored PIN</b>            The last entered PIN is saved in the Trailer Remote Control.            Activation: Touch the button &gt; 5 seconds.            Deactivation: Touch button again for &gt; 5 seconds.</p>
	<p><b>Steering axle is blocked (electronic version extension module 1)</b>            Activation: Touch button.            Deactivation: Touch button again.            If the axle is blocked, the upper part of the button ring lights up green.</p>

BUTTON SYMBOL	FUNCTION												
	<p><b>ECAS 2-point control (electronic extension module version 1)</b>            From TEBS E2.5, separate right/left and front/back control is possible if ECAS 2-point control is installed.</p> <p>The structure can be completely lifted or lowered by just actuating the Lifting / Lowering button.</p> <p>To carry out separate control, you must switch to a separate menu where the Lifting / Lowering button is actuated for more than 2 seconds.</p> <p>Switch between the two circuits (front/back or left/right): Button F2 or button F5.</p> <p>The "dead-man's safety system" parameter in the level control field also functions in the Trailer Remote Control.</p> <p>The selected circuit flashes in the display.</p> <p style="text-align: center;"><b>Semitrailers with independent wheel suspension</b></p> <table style="width: 100%; text-align: center;"> <tr> <td>Left</td> <td>Right</td> <td>Both</td> </tr> <tr> <td>  </td> <td>  </td> <td>  </td> </tr> </table> <p style="text-align: center;"><b>Drawbar trailer</b></p> <table style="width: 100%; text-align: center;"> <tr> <td>Rear axle</td> <td>Front axle</td> <td>Both</td> </tr> <tr> <td>  </td> <td>  </td> <td>  </td> </tr> </table>	Left	Right	Both				Rear axle	Front axle	Both			
Left	Right	Both											
													
Rear axle	Front axle	Both											
													
	<p><b>Volume control</b>            Button tones, system messages and TailGUARD™ functions are influenced with volume control.</p> <p>Deactivating the Trailer Remote Control beeper and external buzzer connected to the electronic extension module if necessary: Touch the button &lt; 2 seconds.</p> <p>Switching off is only possible temporarily for the current reversing move. The volume control can only be switched off if reverse gear is engaged and TailGUARD™ is activated.</p> <p>Call up menu "Volume": Touch the button &gt; 2 seconds.</p> <p>The middle LED row is illuminated and shows the set volume.</p> <p>The volume can now be set between 0 and 9 with buttons F2 and F5. The default is 5.</p> <p>The availability of the +/- functionality on buttons F2 and F5 is indicated by the upper part of the button ring flashing.</p> <p>Saving the volume: Touch button for &gt; 2 seconds or if no button is touched for &gt; 5 seconds.</p> <p>At a volume of less than 4, the external beeper is switched off while TailGUARD™ is activated.</p> <p>If the value is less than 3, the Trailer Remote Control value is set to 3 again after the next restart.</p>												

## Setting the distance display

For displaying the distance to an object, two modes are available, differing in display, object distance and the definition of the monitored area.

By touching buttons F1 and F6 at the same time, you can switch between the two modes. An acoustic signal confirms the change.

### ISO 12155 mode

In this mode, the display is in accordance with the distance values defined in ISO 12155 and the defined resolution.

The LEDs that are actuated are always only green, only yellow or only red.

### WABCO Standard mode

In this mode, the display is slightly more detailed than in ISO 12155 mode.

By illuminating individual rows of LEDs, the object orientation can be displayed for right-middle-left behind the vehicle for individual objects.

If the object is not clearly detected, the object that is nearest the vehicle is displayed in case of doubt.

In WABCO standard mode, the green and yellow LEDs are also actuated when the distance to the object is reduced. The lighting is constantly on during the procedure.

Detailed display can only occur for the levels in which 3 sensors are attached. If only 2 sensors are attached in a level, completed LED rows are always displayed.

In the following table, the monitored areas and the display of the LED rows are shown:

LEDS	OBJECT DISTANCE	
	ISO 12155 MODE	WABCO STANDARD MODE
green	> 300 cm	permanently on
yellow	300 - 181 cm; flashing 2 Hz	300 - 150 cm; flashing 2 Hz
red	180 - 71 cm; flashing 4 Hz 0.8 m to braking point; flashing 6 Hz from braking point; permanently on	150 - 76 cm; flashing 4 Hz 0.8 m to braking point; flashing 6 Hz from braking point; permanently on

## Brightness control

Pressing the F1 and F4 button at the same time switches to brightness control for the LEDs.

There are three brightness settings (green: dark, yellow: medium brightness, red: maximum brightness).

You can use buttons F2 and F5 (+/-) to switch between brightness settings.

If the *Brightness control active* parameter has been set in the TEBS E diagnostic software, automatic mode with automatic light control can be selected (display in LED field: A).

## Configuration

The Trailer Remote Control is configured using the TEBS E diagnostic software.

### Predefined configurations for button allocations

CONFIGURABLE BUTTONS	OPTION 1 (WABCO STANDARD)	OPTION 2	OPTION 3
F1	Forced lowering	ECAS lifting	ECAS lifting
F2	Traction help	Traction help	Traction help
F3	Volume control	Unloading level	Volume control
F4	Immobilizer	ECAS lowering	ECAS lowering
F5	Manoeuvring assistance	Tilt warning	Driving level II
F6	Switch off TailGUARD™	Road finisher brake	OptiTurn™ / OptiLoad™ on / off

The Trailer Remote Control is delivered with the WABCO Standard configuration (option 1). The buttons can also be configured any other way.

Exceptions:

- The immobilizer can only be programmed on F4 or F6.
- The volume and road finisher brake can only be programmed on F1, F3, F4 or F6.

## 10.3 Operating the ECAS level control

### 10.3.1 Operating the ECAS level control (without eTASC)

**!** Only one remote control unit / box can be used. If multiple remote control boxes / units are to be installed, the data lines (clock / data) for the inactive remote control boxes/units must be disconnected.





















































































Simultaneous use of the remote control unit / box, Trailer Remote Control and SmartBoard is possible.

**TEBS E2.5**

As of version TEBS E2.5, ECAS 2-point control, and thus side-dependent lifting or lowering, can also be implemented with the Trailer Remote Control.

Besides the Trailer Remote Control, the following control units can be used for operating the traction help. More detailed information on using the Trailer Remote Control ▶ chapter "10.2 Operation with the Trailer Remote Control", page 181.

# Operation

	CONTROL UNIT 446 056 11X 0	CONTROL BOX 446 156 02X 0	SMARTBOARD 446 192 11X 0	CONTROL UNIT 446 056 25X 0	LIFTING / LOWERING BUTTON
					
Lift body	1.  2. 		1.  2.  3.  4. 	1.  2. 	
Lower body	1.  2. 		1.  2.  3.  4. 	1.  2. 	
Cancel lifting/lowering					
Driving level I (normal level) *) Time dependent on Parameter setting	1.  2. 		1.  2.  3. 	1.  2.  3. 	 and  *)
Driving level II *) Time dependent on Parameter setting	1.  2. 		1.  2.  3. 	1.  2.  3. 	 and  *)
Select/deselect unloading level	-	-	1.  2.  3. 	-	-
Select memory level (M1)	Press simultaneously:  	-	1.  2.  3.  4.  (press 5 seconds)	Press simultaneously:  	-
Save memory level (M1)	Press simultaneously:  	-		Press simultaneously:  	
Select memory level (M2)	Press simultaneously:  	-	1.  2.  3. 	Press simultaneously:  	-
Save memory level (M2)	Press simultaneously:  	-		Press simultaneously:  	
Activate Standby: Towing vehicle hitched. Press button within 30 seconds of switching the ignition off. Trailer level control is active, e.g. during ramp operation			1. Within 30 seconds:  2.  3. 	-	-
Stop stand-by control	> 5 seconds: 	> 5 seconds: 		-	-

## 10.3.2 Operating ECAS level control with eTASC

The vehicle is raised and lowered simply by means of turning the lever.

As soon as the desired height is reached, the lever is turned back downwards.

A height adjusted by means of the lever is controlled by TEBS E and maintained even with subsequent changes to load, provided the following requirements are met:

- Ignition turned on or ECAS stand-by time active
- Parameter *No level control when stationary disabled*, ▶ chapter "6.3 Integrated electronically controlled air suspension system (ECAS)", page 66.
- "Level control off" switch open

If the lever is operated while TEBS E controls a level change, TEBS E is unable to identify the operating request correctly.

! Any level changes controlled by TEBS E should be completed before changing the level using the hand lever.

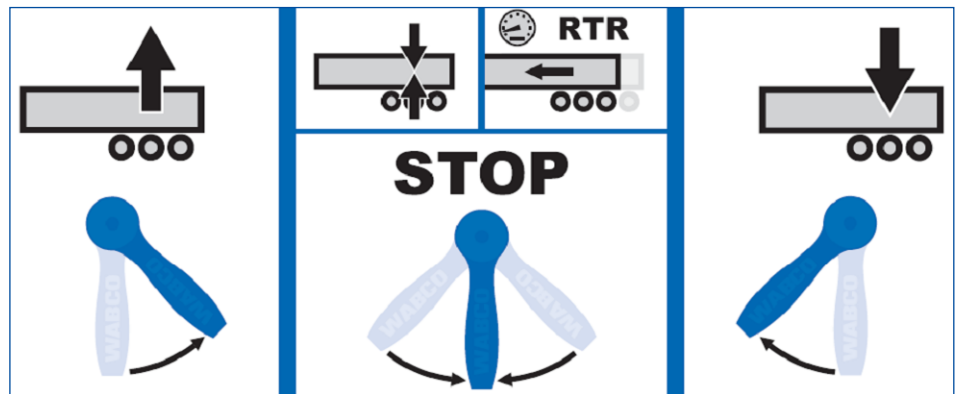









## 10.4 Operating the traction help

Besides the Trailer Remote Control, the following control units can be used for operating the traction help. More detailed information on using the Trailer Remote Control ▶ chapter "10.2 Operation with the Trailer Remote Control", page 181.



















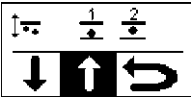

	CONTROL UNIT 446 056 11X 0	CONTROL BOX 446 156 02X 0	SMARTBOARD 446 192 11X 0
Start traction help (acts on axle 1 on semitrailers)	Press simultaneously: 		1.   2.

Manually terminating the function is only possible via the "Forced lowering" button / switch.

## 10.5 Operating OptiLoad™ / OptiTurn™

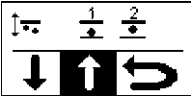
	CONTROL UNIT 446 056 11X 0	CONTROL BOX 446 156 02X 0	SMARTBOARD 446 192 11X 0
			
Start manoeuvring assistance (OptiTurn™) (acts on axle 3 of semitrailers)	Press simultaneously:  	-	
Start manoeuvring assistance (OptiTurn™) automatically. If OptiLoad™ is to be used, OptiTurn™ parameters must be defined first!	-	-	1.   2. 

## 10.6 Operating the lifting axles

	CONTROL UNIT 446 056 11X 0	CONTROL BOX 446 156 02X 0	SMARTBOARD 446 192 11X 0	CONTROL UNIT 446 056 25X 0	LIFTING / LOWERING BUTTON
					
Raise lifting axle(s)	1.  2. 		1.   2. 	1.  2. 	
Lower lifting axle(s)	1.  2. 		1.   2. 	1.  2. 	Button / switch – using "Forced lowering" function Deactivation of the automatic lifting axle function

! You can use the "Forced lowering" button / switch to toggle between to "forced lowering" and "fully automated lifting axle" modes.

### TEBS E4

From TEBS E4, the lifting axle function can also be switched off completely.

On vehicles with several separately controlled lifting axles, switching off the 1st lifting axle will lower it, allowing the 2nd lifting axle to be raised.



## 10.7 Operating the Immobilizer

A more precise description of how to operate the immobilizer with the SmartBoard can be found in the document "SmartBoard – System description", chapter "2 General information", page 7 => section "Technical documents".

More information on operating the immobilizer with the Trailer Remote Control, ▶ chapter "10.2 Operation with the Trailer Remote Control", page 181.

## 11 Workshop notes

### 11.1 Maintenance

The TEBS E system is maintenance-free.

**!** Drive to the next workshop immediately if warning messages occur.

### 11.2 System training and PIN

After participating in a training session or E-Learning, you can request a PIN for the TEBS E diagnostic software from us. You can then use this personal identification number to enable enhanced functions in the software that allow you to modify the settings in electronic control units.

TEBS E2

The training session or the post-training must have taken place in 2010 or later.

ACTION REQUIRED	PIN TYPE	TRAINING
Calibrating height sensors	PIN 2	TEBS E training or E-Learning
Changing the modulator using a protected parameter set	PIN 2	TEBS E training or E-Learning
Setting all function parameters	PIN	TEBS E training



#### Ordering the TEBS E diagnostic software

- Open the myWABCO website:  
<http://www.wabco-auto.com/en/aftermarket-services/mywabco/>

Help on logging in can be obtained by pressing the *Step-by-step instructions* button.

After you have successfully logged in, you can order the TEBS E diagnostic software via myWABCO.

Please contact your WABCO partner if you have any questions.



## 11.3 Diagnosis hardware

The TEBS E only enables diagnosis via one of the CAN interfaces ▶ following options.

The ISO 11898-conformant CAN interface can be used for connecting SUBSYSTEMS such as OptiTire™, the telematics unit, SmartBoard or the electronic extension module.

For further information, please refer to the publication "Diagnosis – Product Overview", ▶ chapter "2 General information", page 7 => section "Technical documents".

### Option 1 – diagnosis conforming to ISO 11992 (CAN 24 V); via the 7-pin ISO 7638 CAN connection

REQUIREMENT	DIAGNOSIS HARDWARE	
ISO 7638 disconnecting adapter with CAN socket 446 300 360 0 	Diagnostic Interface (DI-2) with USB port (for connection to a PC) 446 301 030 0 	CAN diagnostic cable 446 300 361 0 (5 m) / 446 300 362 0 (20 m) 

### Option 2 – Diagnosis according to ISO 11898 (CAN 5 V): via an external diagnosis connection

REQUIREMENT	DIAGNOSIS HARDWARE	
External diagnostic socket with yellow cap Only TEBS E Modulators (Premium) 449 611 XXX 0 	Diagnostic Interface (DI-2) with USB port (for connection to a PC) 446 301 030 0 	CAN diagnostic cable 446 300 348 0 

## Diagnosis

Carry out a system diagnosis if you notice anything conspicuous or warning lamps / indicators are lit.

Current faults as well as intermittent ones are stored in the TEBS E diagnostic memory and displayed via the TEBS E diagnostic software. Repair instructions are provided in the diagnostic software.

After faults have been eliminated, the diagnostic memory should always be cleared.

## 11.4 Tests / Simulations

WHAT MUST BE TESTED?	WHAT MUST BE DONE?
<p><b>Response time</b>                      Response time &lt; 0.44 s.                      There are no requirements for the trailer regarding actuating time.                      Regulations:                      98/12/EC Annex III                      ECE R 13, Annex 6</p>	<p>Preparations for tests with CTU:</p> <ul style="list-style-type: none"> <li>– Set LSV to "laden".</li> <li>– Readjust brakes if necessary.</li> </ul>
<p><b>Power consumption by ABS-equivalent actuations</b>                      Based on the number of equivalent actuations (<math>n_e</math>) from the ABS certificate (§ 2.5), there must still be pressure in the cylinder for a 22.5 % braking at the last brake actuation.                      Disc brake:  <math>n_{e\_EC} = 11</math> actuations  <math>n_{e\_ECE} = 12</math> actuations                      Drum brake:  <math>n_{e\_EC} = 11</math> actuations  <math>n_{e\_ECE} = 13</math> actuations                      Regulation:                      98/12/EC Annex XIV</p>	<ul style="list-style-type: none"> <li>– Fill the trailer reservoir to 8 bar.</li> <li>– At the yellow coupling head with 6.5 bar, brake with the number <math>n_e</math>.</li> <li>– Shut off the supply.</li> <li>– During the last actuation, maintain pressure and measure the cylinder pressure.</li> </ul>
<p><b>Power consumption by spring-type brake actuator</b>                      Demonstrate whether the parking brake of the unhitched vehicle can be released at least 3x.                      Regulations:                      98/12/EC Annex V, § 2.4                      ECE R 13, Annex 8, § 2.4</p>	<ul style="list-style-type: none"> <li>– Support axle(s) with spring-type brake actuator on blocks.</li> <li>– Charge the trailer to 6.5 bar supply pressure (7.5 bar for ECE acceptance).</li> <li>– Unhitch the vehicle.</li> <li>– Release automatic braking (black button).</li> <li>– Vent and charge air into the parking brake system (spring-type brake actuator) 3x by pressing the red button. It must still be possible to turn the wheels with spring-type brake actuators.</li> </ul>
<p><b>Measure the brake forces on all axles of an unladen vehicle on the roller test stand.</b></p>	<ul style="list-style-type: none"> <li>– The lifting axle is lifted and must be lowered for the test.</li> </ul>
<p><b>LSV characteristic when the vehicle is stationary</b>                      The characteristic output by EBS for the unladen or laden vehicle checked with a pressure gauge.</p>	<ul style="list-style-type: none"> <li>– Connect a fine pressure control valve and pressure gauge to the coupling head.</li> <li>– Connect a pressure gauge to the "Brake cylinder" test connection.</li> <li>– Supply the vehicle with electrical power.</li> <li>– Slowly increase the pressure using the fine control valve and record the pressure gauge values.</li> </ul>

SIMULATE WHAT?	WHAT MUST BE DONE?
Laden vehicle	Set bellows pressure < 0.15 bar with: <ul style="list-style-type: none"> <li>– Use rotary valve (ECAS...) to lower the vehicle onto buffer.</li> <li>– Connect a test valve to connection 5 and simulate "laden" bellows pressure.</li> <li>– Set the unladen braking pressure to 6.5 bar in the Parameter setting (new start-up required at the end of the measurements).</li> </ul> ECAS vehicle simulation: A test connection with an integrated directional control valve (463 703 XXX 0) is to be installed in connection 5 of the modulator to simulate a "laden" status if necessary. Please note: Reconnect plug "axle load sensor".
Lowering the lifted lifting axle(s) of the unladen vehicle.	Setting an air suspension pressure < 0.15 bar: <ul style="list-style-type: none"> <li>– Venting the support bellows using the rotary slide valve.</li> <li>– Connecting a pressure simulation to port 5 of the modulator.</li> <li>– TEBS E diagnostic software.</li> </ul>
Test mode for checking the LSV characteristic. The emergency braking function and standstill function are switched off in test mode.	<ul style="list-style-type: none"> <li>– Switch on ignition / electrical power supply with the vehicle stationary and no pressure at the coupling head.</li> </ul> Please note: Test mode is switched off when the vehicle is moved at faster than 2.5 km/h or no later than after 10 minutes.

## 11.5 Replacement and repair

### General safety instructions

- Only qualified personnel of a specialist workshop are authorised to perform repair work on a vehicle.
- Always abide by the vehicle manufacturer's specifications and instructions.
- Always comply with the company's accident prevention regulations as well as national regulations.
- Use protective equipment if required.

### Replacing the TEBS E Modulator

An older TEBS E Modulator can be replaced by a TEBS E Modulator of the same or a newer version.

**!** One exception: Modulators **from version TEBS E4** do not support Trailer Central Electronic.

In most cases it can make sense to use a reconditioned modulator.

TEBS E	PRODUCTION PERIOD	VARIANT	TEBS E REMAN GREEN LABEL
480 102 03X X	40/2007 ... 21/2009	Standard E0	480 102 040 R
480 102 06X X	40/2007 ... 21/2009	Premium E0	480 102 070 R
480 102 03X X	22/2009 ... 10/2011	Standard E1.5	480 102 041 R
480 102 06X X	22/2009 ... 51/2010	Premium E1.5	480 102 071 R

Prior to removing the old modulator the parameter set should be read out and saved to the diagnosis computer wherever possible.

After the TEBS E Modulator has been replaced, the parameter set must be newly written back and a start-up procedure needs to be carried out.

**TEBS E4** From TEBS E4, the odometer reading of a newly installed modulator can be increased to the actual mileage of the vehicle.

TEBS E system training or a successfully completed E-Learning course is necessary for replacing the TEBS E Modulator with protected parameter set. Only after obtaining the PIN2 are you authorised to perform the replacement ▶ chapter "11.2 System training and PIN", page 194.

## Replacing the LIN ultrasonic sensors

When replacing the LIN ultrasonic sensors, they must be re-calibrated ▶ chapter "9.4 Start-up of the LIN ultrasonic sensors", page 175.

## Repair kits

The table below shows a selection of the most important repair kits at a glance:

REPAIR KIT	PART NUMBER
Replacement of TEBS E connector fuses on the ECU	480 102 931 2
Replacement of the modulator couplings	480 102 933 2
Replacement of the PEM for fastening and sealing (set of seals) Can be used for plastic and aluminium PEM	461 513 920 2
Replacement of the PEM (without couplings)	461 513 002 0
Replacement of the pressure sensor <b>Only to be used for the EBS relay valve</b>	441 044 108 0
EBS relay valve (seal set)	480 207 920 2
Replacement of ABS speed sensor 441 032 808 0	441 032 921 2
Replacement of ABS speed sensor 441 032 809 0	441 032 922 2
Removing the pipes from the New Line couplings	899 700 920 2
Repair of an aluminium PEM	461 513 921 2
Repair of a plastic PEM	461 513 922 2

## Tightening torques

Use these tightening torques when replacing valves, plug-in connectors, etc.  
Details on pipe thread ▶ DIN EN ISO 228.

THREAD	MAXIMUM TIGHTENING TORQUE
M 10x1.0	18 Nm
M 12x1.5	24 Nm
M 14x1.5	28 Nm
M 16x1.5	35 Nm
M 22x1.5	40 Nm
M 26x1.5	50 Nm

## Publications

More detailed information about replacement, repairs and screw fittings can be found in our publications ▶ chapter "2 General information", page 7 => section "Technical documents".

## 11.6 Truck/trailer harmonisation

If there are wear or adjustment problems between the towing and trailer vehicles, the TEBS E diagnostic software can be used for setting an advanced or delayed response with the "Advanced response" parameter.

**!** Change the braking pressures only if the wheel brakes are good and the pads have recently been replaced.

### Checking the response pressures

In order to exclude faulty wheel brake functionality, the response pressures have to be checked first:

- First, measure the braking forces of all axles on a roller test stand and determine the position of the individual vehicles.
    - For trailers the following values should be reached "unladen" and "laden":
      - $p_m = 0.7$  bar = Brake begin
      - 2.0 bar = deceleration approx. 12 %
      - 6.5 bar = deceleration approx. 55 %
- ⇒ If the start of braking is above 0.8 bar, the response pressures on all the wheel brakes must be measured.

### Check the response pressures of all wheel brakes

- Provide the vehicle with compressed air and power.
- Connect the TEBS E diagnostic software.
- Click *Actuation, Default pressure*.
- Jack up the vehicle (1st axle).
- Simulate the bellows pressure for the laden vehicle.
- Turn one wheel and increase the control pressure in 0.1 bar steps (left and right cursor keys).
- Determine the braking pressure (cylinder pressure not control pressure!) at which the wheel becomes difficult or impossible to turn.
- Repeat the test on the other wheels.
- Calculate the average value of the determined response pressures and compare this value with the parameterised value.
  - ⇒ You may need to set the newly determined value in the parameters.

### Example

Defined response pressure = 0.3 bar

measured:

1st axle right = 0.6 bar; 2nd axle right = 0.5 bar; 3rd axle right = 0.5 bar

1st axle left = 0.5 bar; 2nd axle left = 0.5 bar; 3rd axle left = 0.6 bar

Mean response pressure = 0.53 bar => rounded down to 0.5 bar

The difference between the two values of 0.2 bar must be added to the braking pressures.

In this example the laden braking pressures would be adjusted thus:



- 0.3 bar to 0.5 bar
- 1.2 bar to 1.4 bar
- 6.2 bar to 6.4 bar
- and the unladen braking pressure from 1.3 to 1.5 bar

! Any modifications to the control - and braking pressures may only deviate up to a maximum of 0.2 bar from those given in the brake calculation (Parameter setting of the manufacturer). Otherwise a new brake calculation must be generated.

Contact your vehicle manufacturer in this case.

### Creating an advanced response

In the TEBS E diagnostic software, *tab 3, Braking Data* is a field for an *Advanced response*. 0 bar is defined here as default. You can set a value up to  $\pm 0.2$  bar.

A positive value allows the trailer vehicle to brake earlier. A negative value causes the trailer vehicle to brake later.

### Documentation

Document the changes by a print-out of the system label sheet ▶ chapter "9.6 Documentation", page 180.

## 11.7 Disposal / recycling

Do not dispose of electronic devices, batteries, or accumulators together with household refuse. These must instead be handed over to a designated collection point.

Observe the national and regional regulations.

Defective WABCO brake units can be returned to WABCO to guarantee the best possible processing.

Return the TEBS E Modulators in the box for the new or replacement unit to WABCO via used-parts-return. Only this way is the modulator protected sufficiently to be processed inexpensively.

Simply contact your WABCO partner.

# 12 Appendix

## 12.1 Pneumatic connections for TEBS E

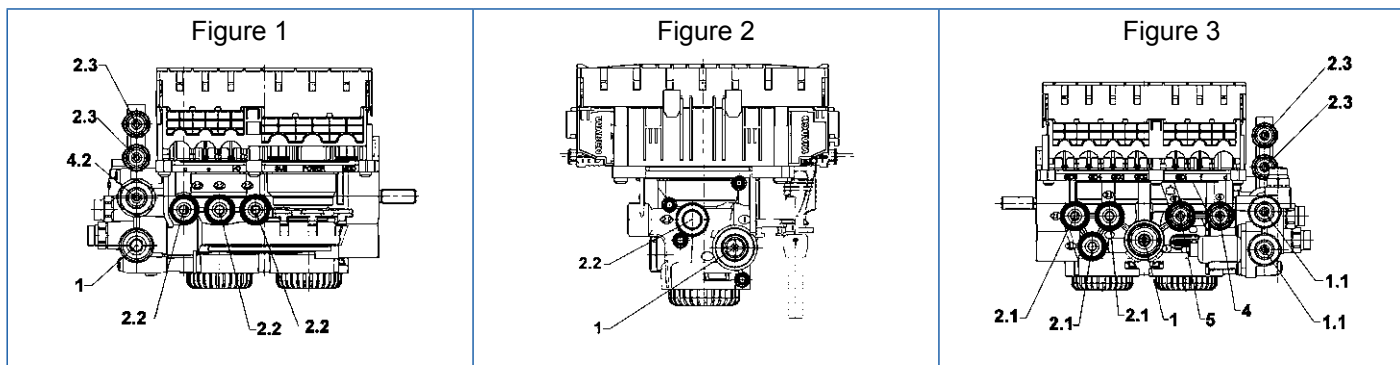

<b>STANDARD: 480 102 XXX 0</b>	<b>030</b>	<b>031<sup>(1) 2) 3)</sup></b>	<b>032<sup>(1)</sup></b>	<b>033<sup>(1) 2)</sup></b>	<b>034<sup>(2)</sup></b>	<b>035<sup>(1) 2)</sup></b>	<b>036<sup>(1) 2) 3)</sup></b>
<b>PREMIUM: 480 102 XXX 0</b>	<b>060</b>	<b>061<sup>(1) 2) 3)</sup></b>	<b>062<sup>(1)</sup></b>	<b>063<sup>(1) 2)</sup></b>	<b>064<sup>(2)</sup></b>	<b>065<sup>(1) 2)</sup></b>	<b>066<sup>(1) 2) 3)</sup></b>
<b>MULTI-VOLTAGE: 480 102 XXX 0</b>	<b>080</b>				<b>084<sup>(2)</sup></b>		

**Figure 1**

Connection	Component							
2.2 Braking pressure	11 Brake cylinder	M 16x1.5	Pipe 12x1.5	Pipe 12x1.5	Pipe 12x1.5	M 16x1.5	Pipe 12x1.5	Pipe 12x1.5
2.2 Braking pressure	11 Brake cylinder	M 16x1.5	Pipe 12x1.5	Pipe 12x1.5	Pipe 12x1.5	M 16x1.5	Pipe 12x1.5	Pipe 12x1.5
2.2 Braking pressure	11 Brake cylinder	M 16x1.5	Pipe 12x1.5	Pipe 12x1.5	Pipe 12x1.5	M 16x1.5	Pipe 12x1.5	Pipe 12x1.5
1 Supply	Reservoir "Brake"	M 22x1.5	Pipe 16x2	Pipe 15x1.5	Pipe 15x1.5	M 22x1.5	Pipe 15x1.5	Pipe 15x1.5
4.2 Control pressure	22 PREV		Pipe 8x1		Pipe 8x1	M 22x1.5	Pipe 10x1	Pipe 8x1
2.3 Tristop™ cylinder	12 Tristop™ cylinder		Pipe 8x1		Pipe 8x1	M 16x1.5	Pipe 8x1	Pipe 8x1
2.3 Tristop™ cylinder	12 Tristop™ cylinder		Pipe 8x1		Pipe 8x1	M 16x1.5	Pipe 8x1	Pipe 8x1

**Figure 2**

Connection	Component							
2.4 / 2.2 Test connection "Brake 2.2"	Pressure gauge for checking	M 16x1.5	Pipe 8x1	Pipe 8x1	Pipe 8x1	M 16x1.5	Pipe 8x1	Pipe 8x1
1 Supply	Reservoir "Brake"	M 22x1.5	Pipe 8x1	Pipe 15x1.5	Pipe 8x1	M 22x1.5	Pipe 15x1.5	Pipe 8x1

**Figure 3**

Connection	Component							
2.1 Braking pressure	11 Brake cylinder	M 16x1.5	Pipe 12x1.5	Pipe 12x1.5	Pipe 12x1.5	M 16x1.5	Pipe 12x1.5	Pipe 12x1.5
2.1 Braking pressure	11 Brake cylinder	M 16x1.5	Pipe 12x1.5	Pipe 12x1.5	Pipe 12x1.5	M 16x1.5	Pipe 12x1.5	Pipe 12x1.5
2.1 Braking pressure	11 Brake cylinder	M 16x1.5	Pipe 12x1.5	Pipe 12x1.5	Pipe 12x1.5	M 16x1.5	Pipe 12x1.5	Pipe 12x1.5

# Appendix

STANDARD: 480 102 XXX 0		030	031 <sup>1) 2) 3)</sup>	032 <sup>1)</sup>	033 <sup>1) 2)</sup>	034 <sup>2)</sup>	035 <sup>1) 2)</sup>	036 <sup>1) 2) 3)</sup>
PREMIUM: 480 102 XXX 0		060	061 <sup>1) 2) 3)</sup>	062 <sup>1)</sup>	063 <sup>1) 2)</sup>	064 <sup>2)</sup>	065 <sup>1) 2)</sup>	066 <sup>1) 2) 3)</sup>
MULTI-VOLTAGE: 480 102 XXX 0		080				084 <sup>2)</sup>		
1 Supply	Reservoir "Brake"	M 22x1.5	Pipe 16x2	Pipe 15x1.5	Pipe 15x1.5	M 22x1.5	Pipe 15x1.5	Pipe 15x1.5
5 Bellows pressure	Air suspension bellows	M 16x1.5	Pipe 8x1	Pipe 8x1	Pipe 8x1	M 16x1.5	Pipe 8x1	Pipe 8x1
4 Control pressure	21 PREV	M 16x1.5	Pipe 8x1	Pipe 8x1	Pipe 8x1	M 16x1.5	Pipe 8x1	Pipe 8x1
1.1 Supply "Air suspension"	Reservoir "Air suspension"		Pipe 8x1		Pipe 12x1.5	M 22x1.5	Pipe 8x1	Pipe 12x1.5
1.1 Supply "Air suspension"	11 Lifting axle valve or 11 ECAS valve		Pipe 8x1		Pipe 12x1.5	M 22x1.5	Pipe 8x1	Pipe 12x1.5
1.1 Supply "Air suspension"	1 Rotary slide valve		Pipe 8x1		Pipe 8x1	M 16x1.5	Pipe 8x1	Pipe 8x1
1.1 Supply "Air suspension"	Levelling valve 1		Pipe 8x1		Pipe 8x1	M 16x1.5	Pipe 8x1	Pipe 8x1
2.3 Tristop™ cylinder	12 Tristop™ cylinder		Pipe 8x1		Pipe 8x1	M 16x1.5	Pipe 8x1	Pipe 8x1
2.3 Tristop™ cylinder	12 Tristop™ cylinder		Pipe 8x1		Pipe 8x1	M 16x1.5	Pipe 8x1	Pipe 8x1

## LEGEND

1)	with threaded couplings	2)	with PEM	3)	with PEM, 2nd generation (plastic)
----	-------------------------	----	----------	----	------------------------------------

## 12.2 Pin assignment

### 12.2.1 TEBS E Modulators

CONNECTIONS	Pin	TEBS E MODULATOR (STANDARD)	TEBS E MODULATOR (PREMIUM, MULTI-VOLTAGE)
<b>MODULATOR, 8-pin Code B, grey</b>			
	1		Ground "Input/Outlet valve"
	2		Backup valve
	3		Ground "Backup valve"
	4		Ground "Pressure sensor"
	5		+24 V / Supply "Pressure sensor"
	6		Actual pressure
	7		Outlet valve
	8		Inlet valve
<b>POWER, 8-pin Code A, black</b>			
	1	Steady positive voltage / Terminal 30	Steady positive voltage / Terminal 30
	2	Ignition / Terminal 15	Ignition / Terminal 15
	3	Ground "warning indicator / warning lamp"	Ground "warning indicator / warning lamp"
	4	Ground "Valves"	Ground "Valves"
	5	Warning indicator / warning lamp	Warning indicator / warning lamp
	6	CAN High 24 V	CAN High 24 V
	7	CAN Low 24 V	CAN Low 24 V
<b>SUBSYSTEM, 8-pin code C, blue</b>			
	1	Steady positive voltage / Terminal 30	Steady positive voltage / Terminal 30
	2	CAN2 High 5 V	CAN2 High 5 V
	3	CAN2 Low 5 V	CAN2 Low 5 V
	4	Ground	Ground
	5	GIO output stage 4-2	GIO output stage 4-2
	6		Controller clock
	7		Controller data
	8	ABS rotational speed sensor c	ABS rotational speed sensor c
<b>IN/OUT 4-pin Code C</b>			
	1	Input 24 N / Trailer Central Electronic / BAT	Input 24 N / Trailer Central Electronic / BAT
	2	Ground	Ground
	3	CAN2 High 5 V from TEBS E4: GIO analogue input	CAN2 High 5 V from TEBS E4: GIO analogue input
	4	CAN2 Low 5 V from TEBS E4: GIO analogue input	CAN2 Low 5 V from TEBS E4: GIO analogue input

# Appendix

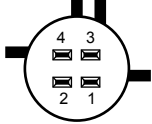
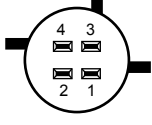
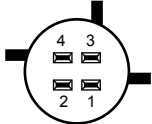
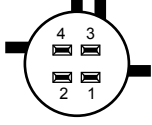
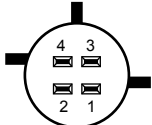
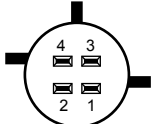
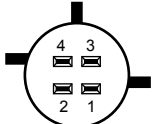
CONNECTIONS	Pin	TEBS E MODULATOR (STANDARD)	TEBS E MODULATOR (PREMIUM, MULTI-VOLTAGE)
<b>ABS e / GIO7, 4-pin Code A/B</b>			
	1		GIO output stage 2-1 (can only be used if GIO3, pin 4 is not being used) <b>As of version TEBS E2:</b> GIO output stage 7-1
	2		Ground
	3		ABS rotational speed sensor e
	4		ABS rotational speed sensor e
<b>ABS c, 4-pin Code A</b>			
	3	ABS rotational speed sensor c	ABS rotational speed sensor c
	4	ABS rotational speed sensor c	ABS rotational speed sensor c
<b>ABS d, 4-pin Code A</b>			
	3	ABS rotational speed sensor d	ABS rotational speed sensor d
	4	ABS rotational speed sensor d	ABS rotational speed sensor d
<b>ABS f / GIO6, 4-pin Code A/B</b>			
	1		GIO output stage 5-2
	2		Ground
	3		ABS rotational speed sensor f
	4		ABS rotational speed sensor f
<b>GIO1, 4-pin Code B</b>			
	1	GIO output stage 1-1	GIO output stage 1-1
	2	Ground	Ground
	3	Analogue input 1	Analogue input 1
	4		Height sensor 1 <b>As of version TEBS E2:</b> Optionally also GIO power stage 7-2
<b>GIO2, 4-pin Code B</b>			
	1	GIO output stage 3-2	GIO output stage 3-2
	2	Ground	Ground
	3		GIO output stage 5-1
	4		GIO output stage 2-2
<b>GIO3, 4-pin Code B</b>			
	1	GIO output stage 1-2	GIO output stage 1-2
	2	Ground	Ground
	3	Analogue input 2	Analogue input 2
	4		GIO output stage 2-1

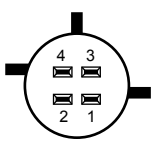
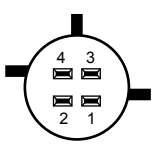
CONNECTIONS	Pin	TEBS E MODULATOR (STANDARD)	TEBS E MODULATOR (PREMIUM, MULTI-VOLTAGE)
<b>GIO4, 4-pin Code B</b>			
	1	GIO output stage 3-1	GIO output stage 3-1
	2	Ground	Ground
	3		Proximity switch Multi-Voltage: K-Line
	4		Height sensor 2
<b>GIO5, 4-pin Code B</b>			
	1		GIO output stage 4-1
	2		Ground
	3		CAN3 High 5 V
	4		CAN3 Low 5 V

## 12.2.2 Electronic extension module

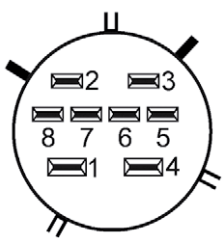
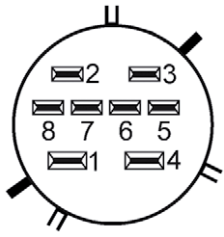
CONNECTIONS	Pin	ELECTRONIC EXTENSION MODULE
<b>POWER, 8-pin Code E</b>		
	1	Switch on ignition (TEBS E Terminal 30)
	2	CAN1 High 5 V
	3	CAN1 Low 5 V
	4	Ground
	5	TEBS Terminal 15 on
	6	Controller Clock1 on
	7	Controller Data1 on
	8	IG (H2) on
<b>SUBSYSTEM, 8-pin code C, blue</b>		
	1	Switch off ignition (TEBS E Terminal 30-X2)
	2	CAN2 High 5 V
	3	CAN2 Low 5 V
	4	Ground
	5	TEBS Terminal 15 on SA 6-2
	6	Controller Clock1 off
	7	Controller Data1 off
	8	IG (H2) off

# Appendix

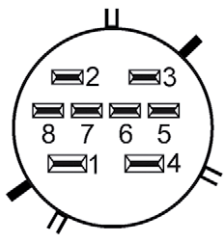
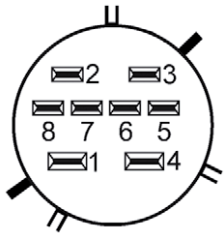
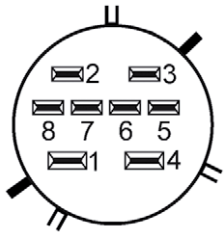
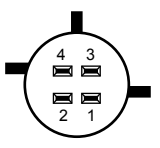
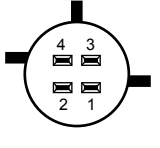
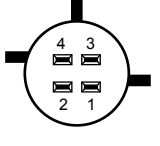
CONNECTIONS	Pin	ELECTRONIC EXTENSION MODULE
<b>GIO10, 8-pin code C</b>		
	5	Battery on / off
	6	Battery ground
	7	Supply "Wake-up button"
	8	Wake-up button
<b>GIO11, 8-pin code C</b>		
	5	Ground "Light"
	6	Clearance lights left off
	7	Clearance lights right off
	8	Ground "Light"
<b>GIO12, 8-pin code C</b>		
	1	Rear light on
	2	CAN3 High 24 V
	3	CAN3 Low 24 V
	4	Ground Light
	5	Clearance lights left on
	6	Clearance lights left off
	7	Clearance lights right off
	8	Clearance lights right on
<b>GIO13, 4-pin code B</b>		
	1	GIO output stage 2-1
	2	Ground
	3	Analogue input 2
	4	Height sensor 2
<b>GIO14, 4-pin code B</b>		
	1	GIO output stage 6-1
	2	Ground
	3	Analogue input 1
	4	Height sensor 1
<b>GIO15, 4-pin code B</b>		
	1	GIO output stage 1-1
	2	Ground
	3	GIO output stage 5-1
	4	GIO output stage 1-2

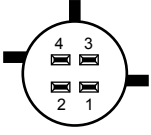
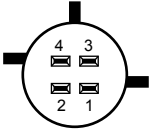
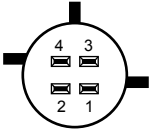
CONNECTIONS	Pin	ELECTRONIC EXTENSION MODULE
<b>GIO16, 4-pin code B</b>		
	1	GIO output stage 5-2
	2	LIN sensor 2
	3	TA 5-1
	4	GIO output stage 4-1 (9 V / 12 V)
<b>GIO17, 4-pin code B</b>		
	1	PWM sensor 1
	2	Ground
	3	LIN sensor 1
	4	GIO output stage 3-2 (9 V / 12 V)
<b>GIO18, 4-pin code B</b>		
	1	PWM sensor 2
	2	Ground
	3	LIN sensor 2
	4	GIO output stage 3-1



## 12.3 Cable overview



### Outling Drawings for cables

- Open the WABCO INFORM online product catalogue:  
<http://inform.wabco-auto.com>
- Search for the cable by entering the cable number.  
Replace "XXX" with "000".

### CAUTION

#### Malfunctions in components and damages to components by crossing the cables

In some cases the cables look very similar (e.g. a 4-pin GIO connector and the 4-pin DIN bayonet). However, this wide range of different cables is necessary because the components to be connected have completely different pin assignments and the cables must not be interchanged, even if they look alike. A precise identification is necessary to rule out malfunctions and damage to components.

- *Identify the cable from the product number and make sure that you connect the proper cables to the components.*

### Colour coding of the connectors

The connectors are colour-coded for better orientation.

#### TEBS E MODULATOR (PREMIUM)

Grey:	GIO, MODULATOR
Black:	POWER, ABS-c, ABS-e, ABS-f, ABS-d
Blue:	SUBSYSTEMS, IN/OUT

#### ELECTRONIC EXTENSION MODULE











Yellow:	POWER Electronic extension module
---------	-----------------------------------

### Coding, 4-pin connectors









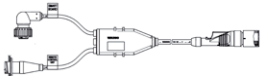

CODE A	CODE B	CODE C

**!** An 8-pin TEBS E connector cannot be connected to the electronic extension module.



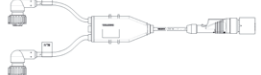



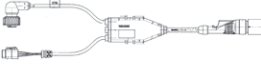

## 12.3.1 Cable overview "Modulator"

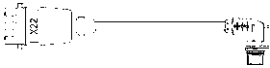
SLOT ON TEBS E MODULATOR	APPLICATION	PART NUMBER	LENGTHS	MODULATOR	COMPONENT
POWER	Power cable for semitrailers 	449 173 090 0	9 m	TEBS E	ISO 7638
		449 173 100 0	10 m	8-pin	7-pin
		449 173 120 0	12 m	Code A	Socket
		449 173 130 0	13 m		
		449 173 140 0	14 m		
		449 173 150 0	15 m		
		449 173 160 0	16 m		
POWER	Power cable with open end 	449 371 120 0	12 m	TEBS E	7-wire open
		449 371 180 0	18 m	8-pin Code A	
POWER	Power cable for drawbar trailers 	449 273 060 0	6 m	TEBS E	7-pin
		449 273 100 0	10 m	8-pin	ISO 7638
		449 273 120 0	12 m	Code A	Connector
		449 273 150 0	15 m		
POWER	Power cable with disconnect 	449 353 005 0	0.5 m	TEBS E	7-pin
		449 353 110 0	11 m	8-pin	ISO 7638
		449 353 140 0	14 m	Code A	DIN bayonet
POWER	Power cable with disconnect 	449 347 003 0	0.3 m	TEBS E	7-pin
		449 347 025 0	2.5 m	8-pin	DIN bayonet
		449 347 080 0	8 m	Code A	
		449 347 120 0	12 m		
		449 347 180 0	18 m		
POWER	Power cable for semitrailers with disconnect plug 	449 133 003 0	0.3 m	ISO 7638 socket	7-pin
		449 133 030 0	3 m		DIN bayonet
		449 133 060 0	6 m		
		449 133 120 0	12 m		
		449 133 150 0	15 m		
POWER	Power cable for semitrailers with disconnect plug 	449 135 005 0	0.5 m	ISO 7638 socket	7-pin
		449 135 025 0	2.5 m		DIN bayonet
		449 135 060 0	6 m		
		449 135 140 0	14 m		
POWER	Power cable for drawbar trailers with disconnect plug 	449 231 060 0	6 m	ISO 7638 plug	7-pin
		449 231 120 0	12 m		DIN bayonet
POWER	Power cable for drawbar trailers with disconnect plug 	449 233 030 0	3 m	ISO 7638 plug	7-pin
		449 233 100 0	10 m		DIN bayonet
		449 233 140 0	14 m		
		449 233 180 0	18 m		
POWER	POWER Extension cable <b>Only for CAN router / CAN repeater!</b> 	894 600 049 0	20 m	DIN bayonet	7-pin
		894 600 051 0	30 m		DIN bayonet
		894 600 032 0	40 m		
		894 600 033 0	50 m		
		894 600 034 0	60 m		
MODULATOR	Cable for ABS relay valve 472 195 037 0 	449 436 030 0	3 m	TEBS E	DIN bayonet
		449 436 080 0	8 m	8-pin Code B	4-pin







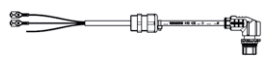

# Appendix

SLOT ON TEBS E MODULATOR	APPLICATION	PART NUMBER	LENGTHS	MODULATOR	COMPONENT
MODULATOR	Cable for EBS relay valve 480 207 001 0 	449 429 010 0 449 429 030 0 449 429 080 0 449 429 130 0	1 m 3 m 8 m 13 m	TEBS E 8-pin Code B	3x DIN bayonet 4-pin
SUBSYSTEMS	Cable for SmartBoard 446 192 11X 0 	449 911 040 0 449 911 060 0 449 911 120 0	4 m 6 m 12 m	TEBS E 8-pin Code C	7-pin DIN bayonet
SUBSYSTEMS	Cable for SmartBoard + ECAS remote control unit 	449 912 234 0	7 m/5 m	TEBS E 8-pin Code C	Socket ECAS remote control unit + 7-pin DIN bayonet
SUBSYSTEMS	Cable for ECAS remote control unit 	449 628 050 0	5 m	TEBS E 8-pin Code C	Socket "ECAS remote control unit"
SUBSYSTEMS	Cable for ECAS control box 	449 627 040 0 449 627 060 0	4 m 6 m	TEBS E 8-pin Code C	7-pin DIN bayonet
SUBSYSTEMS	Cable for OptiTire™ / IVTM 	449 913 050 0	5 m	TEBS E 8-pin Code C	7-pin DIN bayonet
SUBSYSTEMS	Cable for SmartBoard and OptiTire™ 	449 916 182 0 449 916 243 0 449 916 253 0	0.4/4 m 1/6 m 6/6 m	TEBS E 8-pin Code C	7-pin 2x DIN bayonet
SUBSYSTEMS	Cable for TX-TRAILERGUARD™ 	Transics 0942-0388-EBS- 03	5 m	TEBS E 8-pin Code C	HDSCS 6-pin
SUBSYSTEMS	Cable for SmartBoard and TX-TRAILERGUARD™ 	Transics 0942-0388-EBS- 07	3 m/6 m	TEBS E 8-pin Code C	DIN bayonet HDSCS 6-pin
SUBSYSTEMS	Cable for Telematics 	449 914 010 0 449 914 120 0	1 m 12 m	TEBS E 8-pin Code C	4-pin DIN bayonet
SUBSYSTEMS	Cable for Telematics 	449 917 025 0 449 917 050 0	2.5 m 5 m	TEBS E 8-pin Code C	6-pin
SUBSYSTEMS	Cable for Telematics / SmartBoard 	449 920 248 0	3 m/6 m	TEBS E 8-pin Code C	DIN bayonet 6-pin

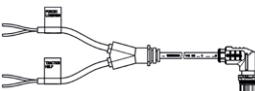

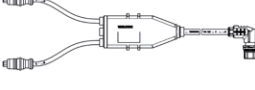
# Appendix

SLOT ON TEBS E MODULATOR	APPLICATION	PART NUMBER	LENGTHS	MODULATOR	COMPONENT
SUBSYSTEMS	Universal cable 	449 437 020 0 449 437 060 0	2 m 6 m	2 m 6 m TEBS E 8-pin Code C	8x open
IN/OUT TEBS E0 to TEBS E3	Cable for Trailer Central Electronic 446 122 001 0 	449 348 020 0	2 m	TEBS E 4-pin Code C	Trailer Central Electronic Slot X22
IN/OUT	Cable for stop light supply (24N) 	449 349 040 0 449 349 060 0 449 349 100 0 449 349 150 0	4 m 6 m 10 m 15 m	TEBS E 4-pin Code C	2-pin, open Cable colours: Pin 1: blue = positive Pin 2: brown = ground
IN/OUT	Cable for stop light supply (24N), traction help and forced lowering 	449 365 060 0	6 m	TEBS E 4-pin Code C	4-pin, open Pin 1: red = positive Pin 2: brown = ground Pin 3: blue PIN 4: yellow / green
IN/OUT	Cable for stop light supply (24N) 	449 350 010 0 449 350 055 0 449 350 090 0	1 m 5.5 m 9 m	TEBS E 4-pin Code C	2-pin DIN bayonet
IN/OUT	Cable for stop light supply (24N), traction help and forced lowering 	449 366 010 0	1 m	TEBS E 4-pin Code C	4-pin DIN bayonet
GIO	Cable for lifting axle valve 463 084 XXX 0, cable for TASC (RtR) 463 090 XXX 0 	449 443 008 0 449 443 010 0 449 443 020 0 449 443 040 0 449 443 060 0 449 443 100 0	0.8 m 1 m 2 m 4 m 6 m 10 m	TEBS E 4-pin Code B	4-pin DIN bayonet
GIO	Cable for ECAS valves 472 905 114 0, 472 880 030 0, lifting axle valve (pulse-controlled) 463 084 100 0, eTASC 463 090 5XX 0 	449 445 010 0 449 445 030 0 449 445 050 0 449 445 060 0	1 m 3 m 5 m 6 m	TEBS E 4-pin Code B	4-pin DIN bayonet
GIO	Cable for ECAS 2-point control mechanism 	449 439 030 0	3 m	4-pin Code B	4-pin DIN bayonet
GIO	Cable for external ECAS to TEBS E 	449 438 050 0 449 438 080 0	5 m 8 m	TEBS E 4-pin Code B	3-wire open with PG coupling





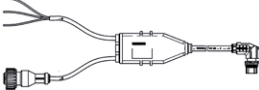
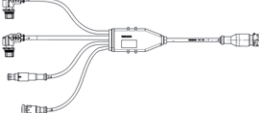
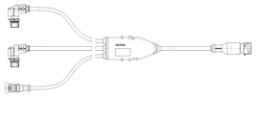
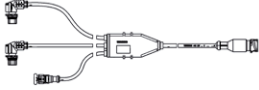

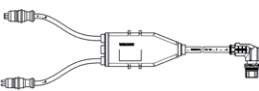
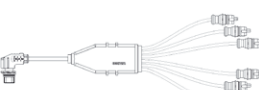
# Appendix

SLOT ON TEBS E MODULATOR	APPLICATION	PART NUMBER	LENGTHS	MODULATOR	COMPONENT
GIO	Cable for height sensor 441 050 100 0 	449 811 010 0	1 m	TEBS E 4-pin Code B	DIN bayonet 4-pin
		449 811 030 0	3 m		
		449 811 050 0	5 m		
		449 811 080 0	8 m		
		449 811 120 0	12 m		
GIO	Cable for pressure sensor 441 040 015 0, 441 044 002 0 	449 812 004 0	0.4 m	TEBS E 4-pin Code B	4-pin DIN bayonet
		449 812 030 0	3 m		
		449 812 040 0	4 m		
		449 812 100 0	10 m		
		449 812 180 0	18 m		
		449 812 260 0	26 m		
		449 812 320 0	32 m		
		449 812 440 0	44 m		
GIO	Cable for traction help 	449 813 050 0	5 m	TEBS E 2-pin Code B	Pin 2: brown = ground Pin 3: black = positive
		449 813 080 0	8 m		
		449 813 150 0	15 m		
GIO	Cable for traction help and forced lowering (or unloading level switch) 	449 815 253 0	6/6 m	TEBS E 4-pin Code B	2x 2-pin open Forced lowering: blue: button 1 brown = ground Traction help: blue = button 2 brown = ground
		449 815 258 0	15/6 m		
GIO	Universal cable 	449 535 010 0	1 m	TEBS E 4-pin Code B	4-pin, open Cable colours: Pin 1: red Pin 2: brown PIN 3: yellow/green Pin 4: blue
		449 535 060 0	6 m		
		449 535 100 0	10 m		
		449 535 150 0	15 m		
GIO	Adapter cable 	449 819 010 0	1 m	TEBS E 4-pin Code B	2-pin
GIO	GIO Y distributor (to be used with TEBS D cables 449 752 XXX 0 and 449 762 XXX 0) 	449 629 022 0	0.4/0.4 m	TEBS E 4-pin Code B	2x 3-pin ABS connector
GIO	Cable for pressure sensor, lifting axle or height sensor 	449 752 010 0	1 m	TEBS E 3-pin round for GIO distributor	4-pin DIN bayonet
		449 752 020 0	2 m		
		449 752 030 0	3 m		
		449 752 080 0	8 m		
		449 752 100 0	10 m		
GIO	Cable for ECAS valve or LACV-IC 	449 761 030 0	3 m	TEBS E 3-pin round for GIO distributor	4-pin DIN bayonet
GIO	Cable for traction help or manoeuvring assistance 	449 762 020 0	2 m	TEBS E 3-pin round for GIO distributor	2-pin open brown = ground black = input
		449 762 080 0	8 m		
		449 762 150 0	15 m		









# Appendix

SLOT ON TEBS E MODULATOR	APPLICATION	PART NUMBER	LENGTHS	MODULATOR	COMPONENT
GIO	Cable for mechanical switch for road finisher brake (not for proximity switch) 	449 763 100 0	10 m	TEBS E 3-pin round for GIO distributor	2-pin open brown = ground black = input
GIO	Cable for traction help, unloading level or height sensor 	449 626 188 0	3 m/4 m	TEBS E 4-pin Code B	4-pin 3-wire open DIN bayonet
GIO and IN/OUT	Distribution cable for 24N, traction help or forced lowering 	449 358 033 0	6.0 m/0.4 m	TEBS E 4-pin Code C 4-pin Code B 2-pin 2-pin	4-pin DIN bayonet
GIO and IN/OUT	Distribution cable for 24N, traction help or forced lowering 	449 356 023 0	1.0 m/0.4 m	TEBS E 4-pin Code C 4-pin Code B 2-pin	4-pin DIN bayonet
GIO and IN/OUT	Cable for 24N or traction help 	449 357 023 0 449 357 253 0	0.4 m/1 m 6 m/6 m	TEBS E 4-pin Code C 4-pin Code B 2-pin	4-pin DIN bayonet
ABS-c, ABS-d, ABS-e, ABS-f	Cable for ABS sensor extension 	449 723 003 0 449 723 018 0 449 723 023 0 449 723 030 0 449 723 040 0 449 723 050 0 449 723 060 0 449 723 080 0 449 723 100 0 449 723 150 0	0.3 m 1.8 m 2.3 m 3 m 4 m 5 m 6 m 8 m 10 m 15 m	TEBS E 4-pin Code A	2-pin ABS socket
GIO and ABS	Cable for ABS sensor plus GIO 6/7 	449 818 022 0	0.4 m/0.4 m	TEBS E 4-pin Code B	1x 2-pin 1x 3-pin ABS connector
GIO	Cable for wear indicator 	449 816 013 0 449 816 030 0	1.3 m 3 m	TEBS E 4-pin Code B	6x 3-pin ABS connector

# Appendix

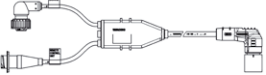
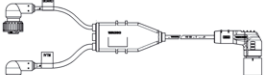



SLOT ON TEBS E MODULATOR	APPLICATION	PART NUMBER	LENGTHS	MODULATOR	COMPONENT
GIO5	Cable for TX-TRAILERGUARD™ (for Premium only) 	Transics 0942-0388-EBS-04	5 m	TEBS E 4-pin Code B	HDSCS 6-pin
GIO5	CAN diagnostic cable (for Premium only) <b>Note: Only diagnostic cable to the interface</b> <b>446 300 348 0</b> 	449 611 030 0 449 611 040 0 449 611 060 0 449 611 080 0	3 m 4 m 6 m 8 m	TEBS E 4-pin Code B	7-pin Diagnostic socket with yellow cap
GIO5	Cable for Telematics (for Premium only) 	449 915 010 0 449 915 120 0	1 m 12 m	TEBS E 4-pin Code B	4-pin DIN bayonet
GIO5	Cable for Telematics (for Premium only) 	449 918 010 0 449 918 025 0 449 918 050 0	1 m 2.5 m 5 m	TEBS E 4-pin Code B	6-pin
GIO5	Cable for Telematics (for Premium only) 	449 610 060 0 449 610 090 0	6 m 9 m	TEBS E 4-pin Code B	4-wire open
GIO	Adapter for 2-circuit lifting axle valve 463 084 010 0 	894 601 135 2	0.15 m		M27
GIO	TASC adapter 	449 447 022 0	0.4 m/0.4 m	2x DIN bayonet	DIN bayonet

## 12.3.2 Cable overview "Electronic Extension Module"

SLOT ON THE ELECTRONIC EXTENSION MODULE	APPLICATION	PART NUMBER	LENGTHS	ELECTRONIC EXTENSION MODULE	COMPONENT
POWER	Power supply cable for electronic extension module 	449 303 020 0	2 m	8-pin Code E	TEBS E 8-pin Code C
		449 303 025 0	2.5 m		
		449 303 050 0	5 m		
		449 303 100 0	10 m		
SUBSYSTEMS	Cable for SmartBoard 	449 906 060 0	6 m	8-pin Code C	7-pin DIN bayonet
SUBSYSTEMS	Cable for remote control unit 	449 602 060 0	6 m	8-pin Code C	Socket for ECAS remote control unit
SUBSYSTEMS	Cable for control box 	449 603 060 0	6 m	8-pin Code C	7-pin DIN bayonet
SUBSYSTEMS	Cable for SmartBoard + ECAS remote control unit 	449 926 234 0	7 m/5 m	8-pin Code C	Socket for ECAS remote control unit + 7-pin DIN bayonet
SUBSYSTEMS	Cable for SmartBoard + OptiTire™ 	449 925 253 0	6 m/6 m	8-pin Code C	7-pin 2x DIN bayonet
SUBSYSTEMS	Cable for Telematics 	449 907 010 0	1 m	8-pin Code C	6-pin
GIO	TEBS E battery cable 	449 807 050 0	5 m	DIN bayonet 4-pin	2-pin Sensor connector
GIO	LIN splitter cable 	894 600 024 0	0.5 m	DIN bayonet 4-pin	2-pin Sensor connector
GIO12	Universal cable 	449 908 060 0	6 m	8-pin Code C	2-pin Sensor connector 2-pin Sensor connector
		449 908 100 0	10 m		



# Appendix

SLOT ON THE ELECTRONIC EXTENSION MODULE	APPLICATION	PART NUMBER	LENGTHS	ELECTRONIC EXTENSION MODULE	COMPONENT
GIO10/GIO11	Distribution cable Battery and/or light 	449 803 022 0	0.4 m/0.4 m	8-pin Code C	
GIO16	<b>TEBS E2 to</b> <b>TEBS E3:</b> Cable for TEBS E battery supply 	449 808 020 0	2 m	4-pin Code B	4-pin Code C (IN/OUT EBS)
GIO17 and/or GIO18	Cable for LIN ultrasonic sensor 	449 806 060 0	6 m	4-pin Code B	Sensor socket
GIO17 and/or GIO18	Cable with device plug socket 	449 747 060 0	6 m	4-pin Code B	Sensor extension cable

## 12.4 GIO schematic diagrams



### GIO schematic diagrams

- Open the WABCO INFORM online product catalogue: <http://inform.wabco-auto.com>
- Search for the schematic diagrams by entering the diagram no.

NAME	SCHEMATIC DIAGRAM	VEHICLES
Immobilizer	841 701 227 0	All trailer vehicles
Electronic parking brake	841 701 264 0	Semitrailer
Standard	841 802 150 0	Semitrailer Central axle trailer
2 lifting axles Maintained residual pressure on lifting axle 1	841 802 151 0	Semitrailer Central axle trailer
External nominal pressure sensor	841 802 152 0	Semitrailer Central axle trailer
Mechanical suspension	841 802 153 0	Semitrailer Central axle trailer
Mechanical suspension	841 802 154 0	Drawbar trailer
Standard with 2 lifting axles	841 802 155 0	Semitrailer Central axle trailer
Standard	841 802 156 0	Drawbar trailer
ECAS 1-point with two 1-circuit LACV	841 802 157 0	Semitrailer Central axle trailer
ECAS 1-point with 1-circuit LACV and 2-circuit ECAS block	841 802 158 0	Semitrailer Central axle trailer
TASC (RtR function)	841 802 159 0	Semitrailer Central axle trailer
ECAS 1-point with 2-circuit ECAS block	841 802 190 0	Semitrailer Central axle trailer
ECAS with 1-circuit LACV and maintained residual pressure	841 802 191 0	Semitrailer Central axle trailer
ECAS with single circuit LACV	841 802 192 0	Semitrailer Central axle trailer
ECAS 1-point with 1-circuit LACV and 2-circuit ECAS block	841 802 194 0	Semitrailer Central axle trailer
ECAS 1-point with 1-circuit LACV and 2-circuit ECAS block	841 802 195 0	Semitrailer Central axle trailer
Road tankers	841 802 196 0	Semitrailer
Road tankers	841 802 197 0	Semitrailer
Road finisher brake	841 802 198 0	Semitrailer
Road finisher brake	841 802 199 0	Semitrailer
OptiTurn™ / OptiLoad™ with ECAS	841 802 235 0	Semitrailer
OptiTurn™ / OptiLoad™ with ECAS	841 802 236 0	Semitrailer

# Appendix

NAME	SCHEMATIC DIAGRAM	VEHICLES
2 lifting axle controls for forklift control on the 2-axle vehicle	841 802 239 0	Central axle trailer
ECAS 2-point control with battery and tag axle control with electronic extension module	841 802 250 0	Semitrailer
ECAS 2-point control with electronic extension module, with auxiliary valve	841 802 252 0	Drawbar trailer
SafeStart (Trailer Safety Brake)	841 802 274 0	Dumper Tanker Roll-off container
TailGUARDlight™	841 802 280 0	All trailer vehicles
TailGUARD™	841 802 281 0	All trailer vehicles
TailGUARDMAX™	841 802 282 0	All trailer vehicles
TailGUARD <sup>Roof</sup> ™	841 802 283 0	All trailer vehicles
TailGUARD <sup>Roof</sup> ™ (rotated ultrasonic sensor)	841 802 284 0	All trailer vehicles
Trailer Extending Control for telescopic vehicles	841 802 290 0	Semitrailer Drawbar trailer
Emergency stop light function	841 802 291 0	All trailer vehicles
Forklift control	841 802 292 0	Central axle trailer
eTASC (lifting and lowering only)	841 802 295 0	Semitrailer
eTASC with lifting axle control	841 802 296 0	Semitrailer
eTASC 2-point, without electronic extension module	841 802 322 0	Drawbar trailer
ECAS 2-point control without electronic extension module	841 802 329 0	Drawbar trailer
ECAS 2-point control without electronic extension module, with lifting axle control	841 802 351 0	Drawbar trailer

## 12.5 Braking diagram



### Braking diagram

- Open the WABCO INFORM online product catalogue: <http://inform.wabco-auto.com>
- Search for the braking diagrams by entering the diagram no.

### Semitrailer

AXLE(S)	ABS SYSTEM	NUMBER	TRISTOP™	OVERLOAD PROTECTION VALVE	PEM	MECHANICAL SUSPENSION	ADDITIONAL TRAILER	PREV	COMMENT
1	2S/2M	841 701 180 0	x	x				x	
1	2S/2M	841 701 181 0	x				x	x	Dolly / hydraulic suspension
1	2S/2M	841 701 182 0	x		x			x	
1	2S/2M	841 701 183 0	x	x				x	12 V
1	2S/2M	841 701 201 0	x					x	
1	2S/2M	841 701 202 0	x						
1	2S/2M	841 701 203 0							
2	4S/2M 2S/2M	841 701 190 0	x	x				x	
2	4S/3M	841 701 191 0	x	x				x	
2	2S/2M	841 701 192 0	x	x					
2	4S/2M 2S/2M	841 701 193 0	x		x			x	
2	4S/3M	841 701 195 0	x		x			x	Only one axle Tristop™!
2	4S/3M	841 701 196 0	x		x			x	
2	4S/2M 2S/2M	841 701 197 0	x		x	x		x	
2	4S/2M 2S/2M	841 701 198 0	x			x		x	one Tristop™ separate
2	4S/3M	841 701 199 0	x	x			x	x	CAN router
2	4S/2M 2S/2M	841 701 270 0	x	x			x	x	CAN router
2	2S/2M	841 701 271 0	x		x			x	CAN router
2	4S/3M	841 701 272 0	x					x	
2	4S/2M 2S/2M	841 701 273 0	x					x	
2	4S/2M 2S/2M	841 701 276 0							
2	2S/2M	841 701 277 0	x	x				x	Select Low
2	2S/2M	841 701 278 0	x	x		x		x	Select Low / optional RSS
3	4S/3M	841 701 050 0	x					x	
3	4S/3M	841 701 055 0	x						CAN repeater
3	4S/3M	841 701 057 0	x	x				x	CAN repeater + Select Low
3	4S/3M	841 701 058 0	x	x				x	CAN repeater
3	4S/2M 2S/2M	841 701 100 0	x						
3	4S/2M 2S/2M	841 701 101 0	x					x	
3	2S/2M	841 701 102 0	x					x	Select Low
3	4S/2M+1M	841 701 103 0	x					x	
3	4S/2M 2S/2M	841 701 104 0	x					x	Trailer Central Electronic
3	4S/2M+1M	841 701 105 0	x			x		x	

# Appendix

AXLE(S)	ABS SYSTEM	NUMBER	TRISTOP™	OVERLOAD PROTECTION VALVE	PEM	MECHANICAL SUSPENSION	ADDITIONAL TRAILER	PREV	COMMENT
3	4S/2M 2S/2M	841 701 106 0	x	x				x	
3	2S/2M	841 701 107 0	x	x				x	Select Low
3	2S/2M	841 701 108 0	x		x			x	Select Low (relay valve)
3	2S/2M	841 701 109 0	x					x	Select Low (relay valve)
3	4S/2M 2S/2M	841 701 110 0	x		x			x	Tristop™ axles 1+2
3	4S/3M	841 701 111 0	x		x			x	
3	2S/2M	841 701 112 0	x	x				x	Select Low (relay valve)
3	4S/3M	841 701 113 0	x	x				x	
3	4S/3M	841 701 114 0	x	x					
3	4S/2M	841 701 115 0	x		x			x	Internal loader
3	4S/2M 2S/2M	841 701 116 0	x	x			x	x	
3	2S/2M	841 701 117 0	x		x			x	Select Low
3	4S/2M+1M	841 701 118 0	x		x			x	
3	4S/3M	841 701 119 0	x		x			x	EBS relay on axle 1
3	4S/2M+1M	841 701 221 0	x		x			x	
3	4S/2M 2S/2M	841 701 222 0							
3	4S/2M+1M	841 701 223 0	x	x				x	
3	4S/3M	841 701 224 0							
3	4S/2M 2S/2M	841 701 227 0	x		x			x	Immobilizer
3	4S/2M 2S/2M	841 701 228 0	x		x		x	x	CAN router
3	4S/2M 2S/2M	841 701 229 0	x	x			x	x	CAN router
3	4S/2M+1	841 701 230 0	x		x		x	x	CAN router
3	4S/2M 2S/2M	841 701 231 0	x		x			x	3 axles Tristop™
3	4S/3M	841 701 232 0	x		x			x	
3	4S/3M	841 701 234 0	x		x		x	x	CAN router
3	4S/3M	841 701 235 0	x	x			x	x	CAN router
3	2S/2M	841 701 236 0	x		x			x	Select Low + optional relay
3	4S/2M 2S/2M	841 701 237 0	x					x	
3	4S/3M	841 701 238 0	x					x	
3	4S/2M 2S/2M	841 701 239 0	x		x			x	
3	4S/2M 2S/2M	841 701 260 0	x	x				x	Multi-Voltage
3	4S/2M 2S/2M	841 701 261 0	x					x	
3	4S/2M	841 701 263 0	x	x				x	CAN repeater / 6x Tristop™
3	4S/2M 2S/2M	841 701 264 0	x		x			x	LACV / electronic parking brake
3	4S/3M	841 701 265 0	x		x			x	3 axles Tristop™
4	4S/3M	841 701 050 0	x					x	

# Appendix

AXLE(S)	ABS SYSTEM	NUMBER	TRISTOP™	OVERLOAD PROTECTION VALVE	PEM	MECHANICAL SUSPENSION	ADDITIONAL TRAILER	PREV	COMMENT
4	4S/3M	841 701 051 0	x	x					Select Low 1st axle
4	4S/3M	841 701 052 0	x		x			x	Select Low 1st axle (relay valve)
4	4S/3M	841 701 053 0	x		x			x	CAN repeater extendable
4	4S/3M	841 701 054 0	x		x			x	CAN repeater extendable
4	4S/3M	841 701 055 0	x						CAN repeater extendable
4	4S/3M	841 701 056 0	x		x			x	Hydraulic suspension
4	4S/3M	841 701 059 0	x	x				x	Auxiliary relay
4	4S/3M	841 701 240 0	x	x				x	CAN repeater extendable
4	4S/3M	841 701 241 0	x		x			x	
4	4S/3M	841 701 242 0	x		x			x	3 axles Tristop™
4	4S/3M	841 701 244 0	x		x			x	3 axles Tristop™ / optional PR switch
4	4S/3M	841 701 245 0	x	x				x	Auxiliary relay at front
4	4S/3M	841 701 246 0	x	x				x	Select Low 1st axle / relay at front
4	4S/3M	841 701 247 0	x	x				x	CAN repeater / auxiliary relay and air reservoir
4	4S/3M	841 701 248 0	x	x				x	CAN repeater / auxiliary relay and air reservoir
6	2S/2M + 2S/2M	841 701 300 0	x		x				CAN router 2x ECU
7	4S/3M + 2S/2M	841 701 171 0	x	x				x	CAN router 2x ECU
7	4S/3M	841 701 210 0	x					x	Hydraulic suspension
7	4S/3M + 2S/2M	841 701 211 0	x		x				CAN router 2x ECU
8	2S/2M + 4S/3M	841 701 301 0	x		x				CAN router 2x ECU
9	4S/3M + 4S/3M	841 701 302 0	x		x				CAN router 2x ECU

## Central axle trailer

AXLE(S)	ABS SYSTEM	NUMBER	TRISTOP™	OVERLOAD PROTECTION VALVE	PEM	MECHANICAL SUSPENSION	ADDITIONAL TRAILER	PREV	COMMENT
1	2S/2M	841 601 290 0	x		x			x	
2	4S/2M 2S/2M	841 601 280 0	x		x			x	
2	4S/3M	841 601 281 0	x	x		x		x	VB unit
2	4S/2M 2S/2M	841 601 282 0	x	x				x	
2	4S/2M 2S/2M	841 601 283 0	x				x	x	Dolly
2	4S/2M 2S/2M	841 601 284 0	x					x	4x Tristop™
2	4S/2M 2S/2M	841 601 285 0	x				x	x	Dolly / hydraulic suspension
2	4S/2M 2S/2M	841 601 286 0	x	x			x	x	Dolly
2	4S/2M 2S/2M	841 601 287 0	x		x		x	x	Dolly CAN router

# Appendix

AXLE(S)	ABS SYSTEM	NUMBER	TRISTOP™	OVERLOAD PROTECTION VALVE	PEM	MECHANICAL SUSPENSION	ADDITIONAL TRAILER	PREV	COMMENT
2	4S/2M 2S/2M	841 601 288 0				x			
2	4S/2M 2S/2M	841 601 289 0	x	x				x	Auxiliary relay / optionally RSS
2	4S/2M 2S/2M	841 601 320 0	x	x			x	x	Dolly CAN router
2	4S/3M	841 601 322 0	x		x			x	4x Tristop™
2	4S/3M	841 601 323 0	x		x			x	
2	2S/2M	841 601 324 0	x	x				x	Hydraulic suspension
2	4S/2M 2S/2M	841 601 325 0							
2	4S/2M 2S/2M	841 601 326 0	x	x				x	4x Tristop™
2	4S/2M 2S/2M	841 601 327 0	x		x	x		x	
2	4S/3M	841 601 328 0	x	x		x		x	VB unit / 4x Tristop™
2	4S/3M	841 601 329 0	x	x		x		x	W unit / 4x Tristop™
2	4S/3M	841 601 392 0				x			VB unit
3	4S/2M 2S/2M	841 601 300 0	x		x			x	
3	4S/2M 2S/2M	841 601 301 0	x	x				x	
3	4S/2M 2S/2M	841 601 302 0							Hydraulic suspension / Multi-Voltage
3	2S/2M	841 601 303 0	x	x				x	Hydraulic suspension
3	4S/2M 2S/2M	841 601 304 0	x	x				x	Hydraulic suspension / Multi-Voltage

## Drawbar trailer

AXLE(S)	ABS SYSTEM	NUMBER	TRISTOP™	OVERLOAD PROTECTION VALVE	PEM	MECHANICAL SUSPENSION	PREV	MODULATOR FRONT AXLE	COMMENT
2	4S/3M	841 601 220 0	x				x	x	
2	4S/3M	841 601 223 0	x	x			x	x	
2	4S/3M	841 601 224 0	x		x		x		
2	4S/3M	841 601 225 0	x		x	x	x		
2	4S/3M	841 601 226 0							
2	4S/3M	841 601 227 0	x	x		x	x	x	
2	4S/3M	841 601 228 0						x	
2	4S/3M	841 601 229 0	x	x			x		
2	4S/3M	841 601 230 0	x				x		
2	4S/3M	841 601 341 0	x		x		x	x	
2	4S/3M	841 601 342 0	x						
2	4S/3M	841 601 345 0	x				x		
2	4S/3M	841 601 347 0				x			
2	4S/3M	841 601 391 0	x	x			x	x	Additional trailer CAN router / Duo-Matic
3	4S/3M	841 601 230 0	x				x		
3	4S/3M	841 601 231 0	x	x			x		

# Appendix

AXLE(S)	ABS SYSTEM	NUMBER	TRISTOP™	OVERLOAD PROTECTION VALVE	PEM	MECHANICAL SUSPENSION	PREV	MODULATOR FRONT AXLE	COMMENT
3	4S/3M	841 601 232 0	x		x		x		
3	4S/3M	841 601 233 0	x	x					
3	4S/3M	841 601 235 0	x		x	x			
3	4S/3M	841 601 236 0	x						
3	4S/3M	841 601 237 0	x		x		x		Additional test valve (supply)
3	4S/3M	841 601 238 0	x			x			Duo-Matic
3	4S/3M	841 601 360 0						x	2 axles, front
3	4S/3M	841 601 361 0	x		x				2 axles, front
3	4S/3M	841 601 362 0				x			
3	4S/3M	841 601 363 0	x	x		x	x		
4	4S/3M	841 601 198 0	x		x		x		Steering axle 4
4	4S/3M	841 601 240 0	x	x			x		
4	4S/3M	841 601 241 0	x	x			x	x	
4	4S/3M	841 601 242 0	x				x		
4	4S/3M	841 601 243 0	x			x		x	
4	4S/3M	841 601 244 0	x		x		x		
4	2x 4S/2M	841 601 245 0	x						CAN router 2x 4S/2M
4	4S/3M	841 601 246 0	x		x			x	
4	4S/3M	841 601 247 0	x		x				
4	4S/3M	841 601 249 0	x	x		x	x	x	Auxiliary relay / RSS
4	4S/3M	841 601 350 0	x	x			x	x	Auxiliary relay / RSS
4	4S/3M	841 601 351 0	x						
4	4S/3M	841 601 352 0	x						
5	4S/3M	841 601 063 0	x		x				
5	4S/3M	841 601 064 0	x						
5	4S/3M	841 601 065 0	x						
5	4S/3M	841 601 066 0	x		x		x		Select Low axle 5
5	4S/3M	841 601 067 0	x		x		x		Tristop™ axle 2+3+4, steering axle 5
5	4S/3M	841 601 069 0	x		x		x		Auxiliary relay at front
5	4S/3M	841 601 380 0	x		x		x		Without relay at front, small brake cylinder



## Index

1-point control.....	18
2-point control.....	19
2S/2M.....	25
2S/2M+SLV.....	25
4S/2M.....	25
4S/2M+1M+SHV.....	25
4S/3M.....	25

## A

ABS active signal.....	97
ABS (Anti-Lock Braking System).....	46
ABS configurations.....	25
2S/2M.....	25
2S/2M+SLV.....	25
4S/2M.....	25
4S/2M+1M+SHV.....	25
4S/3M.....	25
Central axle trailer.....	27
Dolly.....	27
Drawbar trailer.....	27
Internal loader.....	28
Lifting axles.....	26
Multi-axle units.....	26
Semitrailer.....	27
Steering axles.....	26
Tag axles.....	26
ABS relay valve.....	30
ABS speed sensor.....	31
Adhesion-controlled steering axle.....	48
Advance response.....	200
pneumatic.....	45
via CAN.....	45
Air suspension	
conventional.....	15
ECAS.....	18, 66
Anti-Lock Braking System (ABS).....	46
Axle load.....	53
Axle load determination.....	40
Dual circuit.....	40
Single circuit.....	40

Axle load sensor, external.....	85
---------------------------------	----

## B

Battery charge.....	140
Battery-operated.....	33
Battery operation.....	33
Battery supply.....	140
BLWI (brake lining wear indicator).....	98
Bounce control (relaxation function).....	118
Brake calculation.....	23
Brake functions.....	37
ABS.....	46
Emergency braking function.....	49
LSV.....	40
Mechanical suspensions.....	43
Nominal value detection.....	38
Nominal pressure sensor, external.....	38
Overload protection.....	45
Pressure control.....	44
Standstill function.....	49
Test mode.....	49
Brake lining wear indicator (BVA).....	98
Brake release function.....	122
Braking diagram.....	220
Central axle trailer.....	222
Drawbar trailer.....	223
Semitrailer.....	220
Braking system.....	14, 29
Components.....	29
ABS relay valve.....	30
ABS speed sensor.....	31
CAN repeater.....	32
CAN router.....	31
EBS relay valve.....	30
Park-release emergency valve (PREV).....	30
PEM.....	29
Pressure sensor.....	31
Select High valve.....	31
Select Low valve.....	30
TEBS E Modulator.....	29

# Index

Conventional air suspension .....	15	Diagnostic Interface.....	195
Drawbar trailers 4S/3M.....	14	Diagnostic Software.....	173
Scope of application.....	23	Dimensions.....	150
Semitrailer 2S/2M.....	14	DIN 75031 .....	24
System design.....	23	DIN EN ISO 228 .....	24
<b>C</b>			
Cable assembly.....	156	Disposal.....	201
Cable fixation.....	156	Drawbar load reduction (OptiLoad) .....	88
Cable overview.....	209	Drawbar trailer	
Electronic extension module .....	216	ABS configurations.....	27
TEBS E Modulator.....	210	Braking diagram .....	223
Calibration .....	177	Driving level II.....	75
Height sensors .....	177	Driving level III.....	75
CAN repeater.....	32	Driving level I (normal level) .....	75
CAN router.....	31	Driving level IV.....	75
Expert reports.....	24	Dynamic wheelbase control.....	86
Central axle trailer		<b>E</b>	
ABS configurations.....	27	EBS relay valve .....	30
Braking diagram .....	222	ECAS.....	18, 66
Characteristic curve LSV.....	41	Driving level II.....	75
Drawbar trailer.....	41	Driving level III.....	75
Semitrailer .....	41	Driving level I (normal level).....	75
Check response pressures.....	200	Driving level IV .....	75
Colour coding .....	209	external ECAS.....	143
Connector.....	209	Green warning lamp .....	77
Configurations		Memory Level.....	76
Vehicles with TEBS E and RSS .....	156	Nominal level control.....	73
Connections.....	151	Unloading level.....	75
electric.....	151	Unloading level switch.....	76
pneumatic.....	151	ECAS control box .....	69
Course .....	194	ECAS level control system	
PIN .....	194	Operation.....	189
Cumulative odometer .....	50	ECAS remote control unit.....	69
<b>D</b>			
Data communication.....	100	ECAS solenoid valve.....	63, 67, 68
GIO5.....	100	ECE R 48.....	24
Delayed response.....	200	Echo test.....	177
Diagnosis hardware.....	195	E-Learning .....	194
Diagnostic cable .....	195	PIN .....	194
		Electronic extension module.....	67, 132
		Cable overview .....	216
		Pin assignment.....	206

# Index

Electronic parking brake .....	116
Emergency brake alert (emergency stop light).....	123
Emergency braking function .....	49
Emergency stop light (Emergency Brake Alert).....	123
EOL test.....	175
ESD .....	11
eTASC .....	67, 70
Expert reports .....	24
ABS .....	24
ADR/GGVS .....	24
Brake release and relaxation function ..	24
CAN router .....	24
EBS .....	24
Immobilizer .....	24
RSS for TEBS .....	24
TEBS D / TEBS E comparison .....	24
External axle load sensor .....	85
External ECAS.....	143
External nominal pressure sensor .....	38
External systems .....	132
<b>F</b>	
Forced lowering.....	94
Lifting axle function.....	94
Forklift control.....	120
Freely configurable functions.....	130
Analogue function.....	130
Digital function.....	130
Functional test .....	175
Function test when switching on.....	33
<b>G</b>	
GIO.....	59
Analogue Input .....	59
Functions.....	59
Height sensor input .....	59
Power stage .....	59
Schematic diagram.....	218
GIO5.....	100
Data communication.....	100
Power supply.....	100
Green warning lamp .....	77
<b>H</b>	
Hardware .....	195
Height sensor .....	68
Calibration .....	177
Installation .....	158
Histograms .....	57
Hoses .....	29
Diameter.....	29
Lengths.....	29
Hydraulic suspension .....	42
Pressure sensor .....	42
<b>I</b>	
Immobilizer .....	125
Activation.....	128
Expert reports.....	24
Installation .....	160
Operation.....	193
SmartBoard.....	193
PUK.....	128
Installation .....	149, 153
Components, immobilizer.....	160
Electronic extension module .....	162
eTASC .....	172
Height sensor .....	158
TailGUARD .....	161
Ultrasonic sensors.....	161
Trailer Remote Control .....	161
Installation instructions .....	149
Internal loader	
ABS configurations.....	28
ISO 1185.....	24
ISO 4141 .....	24
ISO 7638 .....	24
ISO 11898.....	24
ISO 11992.....	24
ISO 12098 .....	24, 140
ISO/TR 12155.....	24

# Index

ISS 1 & 2 ..... 79

## L

LACV ..... 62

Level control ..... 78

    Deactivation..... 78

Lifting axle ..... 26

    Forced lowering..... 94

    Operation..... 192

    Switching off..... 94

Lifting axle control..... 60

Lifting axle function..... 94

    Forced lowering..... 94

    Switching off..... 94

Lifting axle valve ..... 62

    pulse-controlled ..... 61

    spring returned ..... 61

LSV..... 40

    Characteristic curves..... 41

## M

Maintenance ..... 194

Mechanical suspensions ..... 43

Memory Level..... 76

Mounting on cross member ..... 153

Multi-axle units..... 26

Multi-Voltage..... 33

    Battery operation..... 34

## N

Nominal level control ..... 73

Nominal pressure sensor, external..... 38

Nominal value detection ..... 38

Normal level (driving Level I)..... 75

Notebook function..... 55

## O

Odometer..... 50

    Cumulative odometer ..... 50

    Trip odometer ..... 51

ODR (operating data recorder)..... 56

Operating data record (ODR)..... 56

Operation..... 181

    ECAS level control system..... 189

        with eTASC ..... 191

        without eTASC ..... 189

    Immobilizer ..... 193

    Lifting axles ..... 192

    OptiLoad..... 192

    OptiTurn..... 192

    Traction help..... 191

    Trailer Remote Control ..... 181

OptiLoad (drawbar load reduction)..... 88

    Operation..... 192

OptiTire (tire pressure monitoring)..... 145

OptiTurn (manoeuvring assistance) ..... 86

    Operation..... 192

Overload detection ..... 113

Overload protection ..... 45

## P

Parameter setting ..... 173

Parking brake, electronic..... 116

Park-release emergency valve (PREV)..... 30

PEM..... 29

PIN..... 194

Pin assignment..... 204

    Electronic extension module ..... 206

    TEBS E Modulator..... 204

Pipes..... 29

    Diameter..... 29

    Lengths..... 29

Pneumatic connections ..... 202

Pneumatic redundancy..... 37

Power supply

    GIO5..... 100

    via stop light (24N) ..... 33

Preset ..... 150

Pressure control ..... 44

Pressure sensor ..... 31

    Hydraulic suspension ..... 42

Proximity switch..... 106

Publications ..... 8

<b>R</b>	
Recycling .....	201
Redundancy, pneumatic .....	37
Relaxation function (Bounce Control).....	118
Repair kits.....	198
Repairs .....	197
Replacement .....	197
Return to Ride (RtR).....	79
Road finisher brake .....	102
Mechanical switch .....	102
Proximity switch.....	102
Roll Stability Adviser (tilt warning) .....	111
Roll Stability Support (RSS) .....	47
Installation regulations.....	154
RSS active signal .....	97
RtR (Return to Ride).....	79
<b>S</b>	
SafeStart.....	114
Safety information.....	11, 149
Schematic drawing, GIO.....	218
Scope of application .....	23
Select High valve.....	31
Select Low valve.....	30
Semitrailer	
ABS configurations.....	27
Braking diagram .....	220
Service documentation .....	56
ServiceMind.....	51
Service signal .....	51
Simulations .....	196
Speed signal.....	100
Speed switch ISS 1 & 2.....	79
Standards .....	24
DIN 75031 .....	24
DIN EN ISO 228 .....	24
ECE R 48 .....	24
ISO 1185 .....	24
ISO 4141 .....	24
ISO 7638 .....	24
ISO 11898 .....	24
ISO 11992 .....	24
ISO 12098 .....	24
ISO/TR 12155 .....	24
Standstill function .....	49
Start-up.....	173
Ultrasonic sensors.....	175
Steady positive voltage 1 and 2.....	101
Steering axle.....	26
adhesion-controlled .....	48
Blocking.....	79, 119
Steering axle lock .....	119
Suspension, mechanical.....	43
Symbols.....	7
System design .....	23
System label .....	180
System messages .....	35
System monitoring.....	35
System training.....	194
PIN .....	194
<b>T</b>	
Tag axle control with maintained residual pressure.....	65
Tag axles .....	26
Tag axle valve.....	63
TailGUARD .....	134, 136
Activation.....	137
Components .....	138
Deactivation.....	137
Installation .....	161
System configuration.....	166, 169
TailGUARDlight.....	135
System configuration.....	164
TailGUARDMAX .....	136
System configuration.....	171
TASC .....	80
TEBS E braking system	
Maintenance.....	194
Scope of application .....	23
Simulations.....	196
System design.....	23

Tests .....	196	Replacement .....	198
TEBS E Modulator .....	29	Start-up .....	175
Dimensions .....	150	Unloading level .....	75
Installation in vehicle .....	153	Unloading level switch .....	76
Installation on frame .....	153		
Mounting on cross member .....	153	<b>V</b>	
Multi-Voltage .....	33, 202	Vehicle length, actual (vehicle length indicator) .....	109
Parts .....	32		
Pin assignment .....	204	<b>W</b>	
Ports, pneumatic .....	202	Warning messages .....	181
Premium .....	202	Warnings .....	35
Preset .....	150	Wear indicator .....	98
Replacement .....	197	Wheelbase controls, dynamic .....	86
Standard .....	202	OptiLoad (drawbar load reduction) .....	88
Start-up .....	173	OptiTurn (manoeuvring assistance) .....	86
Technical data .....	150	Wheel load change .....	74
Technical data .....	150	dynamic .....	74
Telematics (TX-TRAILERGUARD) .....	148	static .....	74
Test mode .....	49	Workshop notes .....	194
Tests .....	196		
Tightening torques .....	199		
Tilt warning (Roll Stability Adviser) .....	111		
Tire pressure monitoring (OptiTire) .....	145		
Tires .....	23		
Traction help .....	81		
Activation .....	82		
Operation .....	191		
Valve configurations .....	81		
Trailer Central Electronic .....	144		
Trailer Length Indication (actual vehicle length) .....	109		
Trailer Remote Control .....	142		
Installation .....	161		
Operation .....	181		
Trailing steering axle .....	48		
Trip odometer .....	51		
Truck/trailer harmonisation .....	200		
TX TRAILERGUARD (telematics) .....	148		
<b>U</b>			
Ultrasonic sensors .....	138		





**WABCO**  
a **WORLD** of  
**DIFFERENCE**

**WABCO** (NYSE: WBC) is a leading global supplier of technologies and services that improve the safety, efficiency and connectivity of commercial vehicles. Founded nearly 150 years ago, WABCO continues to pioneer breakthrough innovations for advanced driver assistance, braking, stability control, suspension, transmission automation and aerodynamics. Partnering with the transportation

industry as it maps a route towards autonomous driving, WABCO also uniquely connects trucks, trailers, drivers, cargo, and fleet operators through telematics, as well as advanced fleet management and mobile solutions. WABCO reported sales of \$2.6 billion in 2015. Headquartered in Brussels, Belgium, WABCO has 12,000 employees in 39 countries. For more information, visit

[www.wabco-auto.com](http://www.wabco-auto.com)